

Preface

Copyright

This publication, including all photographs, illustrations and software, is protected under international copyright laws, with all rights reserved. Neither this manual, nor any of the material contained herein, may be reproduced without written consent of the author.

Version 6.0

Disclaimer

The information in this document is subject to change without notice. The manufacturer makes no representations or warranties with respect to the contents hereof and specifically disclaim any implied warranties of merchantability or fitness for any particular purpose. The manufacturer reserves the right to revise this publication and to make changes from time to time in the content hereof without obligation of the manufacturer to notify any person of such revision or changes.

Trademark Recognition

Microsoft, MS-DOS and Windows are registered trademarks of Microsoft Corp.

MMX, Pentium, Pentium-II, Pentium-III, Celeron are registered trademarks of Intel Corporation.

Other product names used in this manual are the properties of their respective owners and are acknowledged.

Federal Communications Commission (FCC)

This equipment has been tested and found to comply with the limits for a Class B digital device, pursuant to Part 15 of the FCC Rules. These limits are designed to provide reasonable protection against harmful interference in a residential installation. This equipment generates, uses, and can radiate radio frequency energy and, if not installed and used in accordance with the instructions, may cause harmful interference to radio communications. However, there is no guarantee that interference will not occur in a particular installation. If this equipment does cause harmful interference to radio or television reception, which can be determined by turning the equipment off and on, the user is encouraged to try to correct the interference by one or more of the following measures:

- Reorient or relocate the receiving antenna.
- Increase the separation between the equipment and the receiver.
- Connect the equipment onto an outlet on a circuit different from that to which the receiver is connected.
- Consult the dealer or an experienced radio/TV technician for help.

Shielded interconnect cables and a shielded AC power cable must be employed with this equipment to ensure compliance with the pertinent RF emission limits governing this device. Changes or modifications not expressly approved by the system's manufacturer could void the user's authority to operate the equipment.

Declaration of Conformity

This device complies with part 15 of the FCC rules. Operation is subject to the following conditions:

- This device may not cause harmful interference, and
- This device must accept any interference received, including interference that may cause undesired operation.

Canadian Department of Communications

This class B digital apparatus meets all requirements of the Canadian Interference-causing Equipment Regulations.

Cet appareil numérique de la classe B respecte toutes les exigences du Règlement sur le matériel brouilleur du Canada.

About the Manual

The manual consists of the following:

Chapter 1 Introducing the Motherboard	Describes features of the motherboard, and provides a shipping checklist. Go to ⇒ page 1
Chapter 2 Installing the Motherboard	Describes installation of motherboard components. Go to ⇒ page 7
Chapter 3 Using BIOS	Provides information on using the BIOS Setup Utility. Go to ⇒ page 25
Chapter 4 Using the Motherboard Software	Describes the motherboard software. Go to ⇒ page 48

Features Translations

Caractéristiques

Processeur	<p>La carte mère utilise un Socket micro PGA 478 broches présentant les caractéristiques suivantes :</p> <ul style="list-style-type: none"> • Supporte un bus frontal (FSB) de 533/400 MHz • Accepte des processeurs Pentium 4 à 1.5G/1.6G/1.7G... 3.06G et plus
Chipset	<p>Les chipsets SiS651 Northbridge et SiS962L Southbridge sont basés sur une architecture novatrice et dimensionnable avec une fiabilité et des performances prouvées.</p> <ul style="list-style-type: none"> • Supporte les CPU de la série Intel Pentium 4 avec des vitesses de transfert de 533/ 400MHz • Support de 12 transactions remarquables • Supporte les SDRAM DDR333/266/200 • Conforme AGP v2.0 • Supporte la Taille de Fenêtre Graphique de 4Moctets à 256Moctets • Réalise une bande passante de 533Mo/s en mode 66MHz x 4 • Intègre un moteur 3D de haute qualité • Conforme aux spécifications PCI 2.2 • Supporte le mode PIO 0,1,2,3,4 et le mode DMA Multiword 0,1,2 • Supporte Ultra DMA 133/100/66 • Trois contrôleurs d'hôte OHCI USB 1.1 indépendant et un contrôleur d'hôte EHCI USB 2.0, supporte jusqu'à six ports • Événements d'éveil système inclus : Bouton d'alimentation, mot de passe de clavier/touche de raccourci, alarme RTC, sonnerie Modem, LAN, Eveil AC'97 et éveil USB <p>Les caractéristiques clé supplémentaires de la carte mère comprennent le support de six ports USB, une liaison AC' 97 pour audio et modem, surveillance matérielle, et gestion d'alimentation ACPI/OnNow.</p>
Memory	<p>La carte mère supporte une SDRAM DDR 266/333. It accommodates two unbuffered 2.5V 184-pin slots. Each slot supports up to 1 GB with a total maximum capacity of 2 GB.</p>
Graphiques	<p>La carte mère comprend un logement AGP qui offre quatre fois la bande passante des spécifications AGP d'origine. AGP technology provides a direct connection between the graphics sub-system and the processor so that the graphics do not have to compete for processor time with other devices on the PCI bus.</p>
USB	<p>The USB 2.0 Controller is compliant with Universal Serial Bus Specification Revision 2.0.</p> <p>The USB 2.0 supports data transfer rates up to 480MB/sec for high-speed devices and specifies a microframe that will be 1/8th of a 1msec frame. This allows the USB 2.0 devices to have small buffers even at high data rates.</p>

	<p>The USB 1.1 connectors and other full speed cables can support the higher speed of USB 2.0 without any changes.</p> <p>The chipset has the following advanced USB features:</p> <ul style="list-style-type: none"> • Compliant with Enhanced Host Controller Interface (EHCI) Specification Revision 0.95 and Universal Host Controller Interface (UHCI) Specification Revision 1.1 • PCI multi-function device consists of two UHCI Host Controllers for full/low-speed signaling and one EHCI Host Controller core for high-speed signaling • Supports PCI-Bus Power Management Interface Specification release 1.1 • Legacy support for all downstream facing ports
AC' 97 Audio Codec	<p>Le codec Audio AC' 97 est conforme aux spécifications AC'97 2.2 répondant aux exigences PC2001 et supportant Sortie S/PDIF. Il possède aussi une mémoire tampon intégrée et PLL interne. Les fonctionnalités comprennent le support du commutateur analogique pour sortie arrière (partagée), la prise de ligne d'entrée (partagée), centre basse (partagée), et prise MIC à la sortie audio 6 canaux.</p> <p>Remarque: Contrôleur audio 4 canaux optionnel.</p>
LAN Interne (optionnel)	<p>Le VT6103 L est un périphérique à Couche Physique pour Ethernet 10BASE-T et 100BASE-TX utilisant des câbles Non blindés de catégorie 5, Blindés de Type 1, et à Fibres Optiques.</p> <ul style="list-style-type: none"> • Double Vitesse – 100/10 Mbps • Half et Full Duplex • Interface MII vers Contrôleur Ethernet • Conforme à tous les Standards IEEE 802.3, 10Base-T et 100Base-Tx Applicables
Options d'Extensions	<p>La carte mère est livrée avec les options d'extensions suivantes:</p> <ul style="list-style-type: none"> • Deux logements PCI 32 bits • Un logement AGP • Un logement de Communications et Network Riser (CNR) (Interface AC'97 seulement) • Deux canaux IDE et une interface de lecteur de disquette <p>La carte mère supporte la maîtrise de bus Ultra DMA avec des vitesses de transfert de 133/100/66 Mo/sec.</p>
E/S Intégrée	<p>La carte mère possède un jeu complet de ports d'E/S et de connecteurs:</p> <ul style="list-style-type: none"> • Deux ports PS/2 pour souris et clavier • Un port série • Un port VGA • Un port parallèle • Quatre ports USB • Un port LAN • Prises audio pour microphone, ligne d'entrée et ligne de sortie

Microprogramme BIOS	<p>Cette carte mère utilise Award BIOS qui permet aux utilisateurs de configurer de nombreuses caractéristiques du système comprenant les suivantes:</p> <ul style="list-style-type: none">• Gestion d'alimentation• Alarmes de réveil• Paramètres de CPU• Synchronisation de CPU et de mémoire <p>Le microprogramme peut aussi être utilisé pour définir les paramètres pour les vitesses d'horloges de différents processeurs.</p>
----------------------------	-------------------------------------------------------------------------------------------------------------------------------------------------------------------------------------------------------------------------------------------------------------------------------------------------------------------------------------------------------------------------------------------------------------------------------------------------------------------------------



Certaines spécifications matérielles et éléments de logiciels peuvent être modifiés sans avertissement.

Features

Prozessor	<p>Das Motherboard verwendet einen Mikro-PGA 478-Pin Sockel mit den folgenden Eigenschaften:</p> <ul style="list-style-type: none"> • Unterstützt 533/400 MHz Frontsidebus (FSB) • Nimmt Pentium 4 Prozessoren mit 1.5G/1.6G/1.7G... 3.05G und darüber auf
Chipsatz	<p>Die Chipsätze SiS651 Northbridge und SiS962L Southbridge basieren auf einer innovativen und skalierbaren Architektur mit bewiesener Zuverlässigkeit und Leistung.</p> <ul style="list-style-type: none"> • Unterstützt CPU der Intel Pentium 4 Serie mit Datentransferraten von 533/ 400MHz • Unterstützt 12 Outstanding-Transactions • Unterstützt DDR333/266/200 SDRAM • Entspricht AGP v2.0 • Unterstützt Graphic Window Size von 4Mbytes bis zu 256Mbytes • Leistung von 533MB/s Bandbreite im 66MHz x 4-Modus • Hochwertiger 3D-Engine integriert • Entspricht PCI 2.2 Spezifikation • Unterstützt PIO-Modus 0,1,2,3,4 und Multiword DMA-Modus 0,1,2 • Unterstützt Ultra DMA 133/100/66 • Drei unabhängige OHCI USB 1.1 Host-Controller und ein EHCI USB 2.0 Host-Controller unterstützen bis zu sechs Schnittstellen • System-Wake-up-Events umfassen: Netzschalter, Tastatur-Kennwort/Hotkey, RTC-Alarm, Modem-Anruf, LAN, AC'97-Wake-up und USB-Wake up <p>Zusätzliche Schlüsseleigenschaften des Motherboards umfassen die Unterstützung für sechs USB-Anschlüsse, ein AC'97-Link für Audio und Modem, Hardwareüberwachung und ACPI/OnNow-Energieverwaltung.</p>
Speicher	<p>Das Motherboard unterstützt DDR 266/333 SDRAM. Es nimmt zwei ungepufferte 2.5V 184-Pin Steckplätze auf. Jeder Steckplatz unterstützt bis zu 1 GB, mit einer maximalen Kapazität von insgesamt 2 GB.</p>
USB	<p>Der USB 2.0 Controller entspricht der Universal Serial Bus Spezifikation Revision 2.0.</p> <p>USB 2.0 unterstützt Datentransferraten von bis zu 480MB/Sek. für Hochgeschwindigkeitsgeräte und spezifiziert einen Mikroframe, der 1/8 eines 1msek Frames darstellt. Dies erlaubt kleine Puffer für die USB 2.0-Geräte selbst bei hohen Datenraten.</p> <p>Die USB 1.1-Anschlüsse und andere Vollgeschwindigkeitskabel unterstützen die höhere Geschwindigkeit von USB 2.0 ohne Änderungen.</p> <p>Der Chipsatz verfügt über die folgenden erweiterten USB-Merkmale:</p> <ul style="list-style-type: none"> • Entspricht Enhanced Host Controller Interface (EHCI) Spezifikation Revision 0.95 und Universal Host Controller Interface (UHCI) Spezifikation Revision 1.1 • Multifunktions-PCI-Gerät besteht aus zwei UHCI Host-

	<p>Controllern für Signalübertragung bei voller und niedriger Geschwindigkeit sowie einem EHCI-Host</p> <ul style="list-style-type: none"> • Controllerkern für Hochgeschwindigkeits-Signalübertragung • Unterstützt PCI-Bus Power Management Interface Spezifikation Ausgabe 1.1 • Legacy-Unterstützung für alle Downstream-Ports
Grafik	<p>Das Motherboard enthält einen 4x AGP-Steckplatz mit der vierfachen Bandbreite der ursprünglichen AGP-Spezifikation. AGP-Technologie bietet eine direkte Verbindung zwischen dem Grafiksubsystem und dem Speicher, so dass die Grafik nicht mit anderen Geräten auf dem PCI-Bus um Prozessorzeit wetteifern muss.</p>
AC' 97 Audio Codec	<p>Der AC' 97 Audio-Codec ist kompatibel mit der AC' 97-Spezifikation für PC2001 und unterstützt S/PDIF Out. Weiterhin verfügt es über einen internen Puffer und PLL. Seine Funktionen umfassen Unterstützung für analogen Switch für den Hinterausgang (gemeinsam), die Line-in-Buchse (gemeinsam), Mitte/Bass (gemeinsam) und die MIC-Buchse für 6-Kanal-Audioausgang.</p> <p>Anmerkung: Optionaler 4-Kanal Audiocontroller.</p>
Integriertes LAN (optional)	<p>Das VT6103L ist ein Physical-Layer-Gerät für Ethernet 10BASE-T und 100BASE-TX bei Benutzung von nicht abgeschirmten Kategorie 5-Kabeln, abgeschirmten Typ 1-Kabeln und Glasfaserkabeln.</p> <ul style="list-style-type: none"> • Zwei Geschwindigkeiten – 100/10 MB/Sek. • Halb- und Vollduplex • MII Interface-zu-Ethernet Controller • Entspricht allen geltenden IEEE 802.3, 10Base-T und 100Base-Tx-Standards
Erweiterungsoptionen	<p>Das Motherboard bietet die folgenden Erweiterungsoptionen:</p> <ul style="list-style-type: none"> • Zwei 32-bit PCI-Steckplätze • Ein AGP-Steckplatz • Einen Steckplatz für Communications und Network Riser (CNR) (nur AC'97 Interface) • Zwei IDE-Kanäle und eine Schnittstelle für ein Floppydiskettenlaufwerk <p>Das Motherboard unterstützt Ultra DMA Bus-Mastering mit Übertragungsraten von 133/100/66 MB/s.</p>
Integrierte I/O	<p>Das Motherboard verfügt über einen kompletten Satz von I/O-Schnittstellen und Anschlüssen:</p> <ul style="list-style-type: none"> • Zwei PS/2-Schnittstellen für Maus und Tastatur • Eine serielle Schnittstelle • Einen VGA-Anschluss • Eine parallele Schnittstelle • Vier USB-Schnittstellen • Eine LAN-Schnittstelle • Audiobuchsen für Mikrofon, Line-in und Line-out

BIOS Firmware	<p>Dieses Motherboard setzt das Award BIOS ein, mit dem der Anwender viele Systemeigenschaften selbst konfigurieren kann, einschließlich der folgenden:</p> <ul style="list-style-type: none">• Energieverwaltung• Wake-up Alarm• CPU-Parameter• CPU- und Speichertiming <p>Mit der Firmware können auch die Parameter für verschiedene Prozessortaktgeschwindigkeiten eingestellt werden.</p>
--------------------------	-----------------------------------------------------------------------------------------------------------------------------------------------------------------------------------------------------------------------------------------------------------------------------------------------------------------------------------------------------------------------------------------------------------------------------------------



Bestimmte Hardwarespezifikationen und Teile der Softwareausstattung können ohne weitere Ankündigung abgeändert werden.

Caratteristiche

Processor	<p>La scheda madre usa un socket micro PGA 478-pin con le seguenti caratteristiche:</p> <ul style="list-style-type: none"> • Supporto per il bus di sistema frontside (FSB) 533/400 MHz • Alloggia processori Pentium 4 a 1,5G/1,6G/1,7G... 3,08G e superiore
Chipset	<p>I chipset SiS651 Northbridge e SiS962L Southbridge sono basati su un'architettura innovativa e scalabile di provata affidabilità e di eccellenti prestazioni.</p> <ul style="list-style-type: none"> • Supporto per le CPU della serie Pentium 4 con velocità di trasferimento dati fino a 533/400MHz • Supporta 12 transazioni in esecuzione • Supporta DDR333/266/200 SDRAM • AGP v2.0 Compatibile • Supporta una finestra grafica da 4MBytes a 256MBytes • Funzionamento a 533MB/s di larghezza di banda nella modalità 66MHz x 4 • Motore 3D integrato di altissima qualità • Conforme alle specifiche PCI 2.2 • Supporta le modalità PIO 0,1,2,3,4 e le modalità Multiword DMA 0,1,2 • Supporta Ultra DMA 133/100/66 • Tre interfacce OHCI USB 1.1 indipendenti e una interfaccia EHCI USB 2.0, con supporto fino a sei porte • Gli eventi wake-up del sistema includono: Pulsante di accensione, tasto rapido/password per la tastiera, allarme RTC, Modem ring-in, LAN, AC'97 wake-up e USB wake-up <p>Caratteristiche aggiuntive includono il supporto per sei porte USB, un collegamento AC'97 per audio e modem, monitoraggio hardware e gestione energetica ACPI/OnNow.</p>
Memoria	<p>La scheda madre supporta DDR 266/333 SDRAM. Presenta due slot privi di memoria di tampone (184 pin) a 2,5V; ogni slot supporta fino a 1GB di memoria per un totale massimo di 2 GB</p>
USB	<p>Il controller USB 2.0 è compatibile con Universal Serial Bus Specification Revision 2.0.</p> <p>USB 2.0 supporta trasferimento dati fino a 480MB/sec per dispositivi ad alta velocità disponendo di un microframe pari a 1/8 di 1msec frame. Ciò permette ai dispositivi USB 2.0 di disporre di piccole memorie di tampone anche ad alte velocità di trasferimento dei dati.</p> <p>I connettori USB 1.1 e altri cavi a velocità completa possono supportare la maggiore velocità di USB 2.0 senza necessità di alcuna modifica.</p> <p>Il chipset è dotato delle seguenti funzioni USB avanzate:</p> <ul style="list-style-type: none"> • Compatibile con Enhanced Host Controller Interface (EHCI) Specification Revision 0.95 e Universal Host Controller Interface (UHCI) Specification Revision 1.1 • Il dispositivo PCI multifunzione consiste di due schede di controllo UHCI per la trasmissione segnali alta velocità/bassa velocità e una scheda di controllo EHCI

	<p>per la trasmissione segnali ad alta velocità.</p> <ul style="list-style-type: none"> • Supporto per interfaccia risparmio energia bus PCI specifiche release 1.1 • Supporto per tutte le porte downstream precedenti
Grafica	<p>La scheda madre include uno slot AGP che fornisce fino a quattro volte l'ampiezza di banda delle caratteristiche tecniche dell'AGP originale. La tecnologia AGP fornisce una connessione diretta tra il sottosistema grafico e la memoria in modo tale che non vi sia competizione tra i bus PCI e quelli grafici per l'utilizzo del processore.</p>
AC' 97 Audio Codec	<p>Il codec Audio AC'97 è conforme alla specifica AC'97 2.2 che soddisfa i requisiti PC2001 e supporta Uscita S/PDFI. Inoltre ha una memoria tampone interna e PLL interno. Le caratteristiche includono supporto per interruttore analogico sull'uscita posteriore (condivisa), il jack di ingresso linea (condiviso), centrale/bassi (condivisi), e jack MIC per fornire un'uscita a 6 canali audio.</p> <p>Nota: Controller audio opzionale a 4 canali</p>
LAN integrata (opzionale)	<p>La scheda VT6103L è un dispositivo Physical Layer per Ethernet 10BASE-T e 100BASE-TX che usa cavi della categoria 5 non schermati, Tipo 1 schermati e ottici.</p> <ul style="list-style-type: none"> • Dual Speed – 100/10 Mbps • Half e Full Duplex • Interfaccia MII su Ethernet Controller • Conforme a tutti gli standard applicabili IEEE 802.3, 10Base-T e 100Base-Tx
Opzioni di espansione	<p>La scheda madre presenta le seguenti opzioni di espansione:</p> <ul style="list-style-type: none"> • Due slot PCI 32 bit • Uno slot AGP • Una slot Communications e Network Riser (CNR) (solo interfaccia AC'97) • Due canali IDE e un'interfaccia lettore disco floppy <p>La scheda supporta il bus mastering Ultra DMA con transfer rate 133/100/66 MB/sec.</p>
Inizializza I/O	<p>La scheda madre è dotata da una serie completa di porte e connettori I/O:</p> <ul style="list-style-type: none"> • Due porte PS/2 per tastiera e mouse • Una porta seriale • Una porta VGA • Una porta parallela • Quattro porte USB • Una porta LAN • Jack audio per microfono, ingresso linea e uscita linea

Firmware BIOS	<p>Questa scheda madre adotta un BIOS Award che permette agli utenti di configurare le caratteristiche principali del sistema, inclusi:</p> <ul style="list-style-type: none">• Gestione energia• Allarmi wake up• Parametri CPU• Temporizzazione CPU e memoria <p>Il firmware può anche essere usato per impostare i parametri per diverse velocità di clock.</p>
----------------------	-------------------------------------------------------------------------------------------------------------------------------------------------------------------------------------------------------------------------------------------------------------------------------------------------------------------------------------------------------------------------------------------------------------



Alcune specifiche hardware ed elementi software sono soggetti a variazioni senza preavviso.

Características

Procesador	<p>La placa principal usa un micro receptáculo PGA de 478 pines que tiene las siguientes características:</p> <ul style="list-style-type: none"> • Soporta un bus frontal de 533/400 MHz (FSB)[™] • Acomoda procesadores Pentium 4 en 1.5G/1.6G/1.7G... 3.0G y por encima de estos
Chipset	<p>Los chipsets Northbridge SIS651 Southbridge SIS962L están basados en una arquitectura innovadora y escalable con fiabilidad y rendimiento comprobados.</p> <p>La placa principal puede soportar ambos chipsets Northbridge y Southbridge mencionados arriba. Referencia abajo sobre combinación y respectivos detalles:</p> <ul style="list-style-type: none"> • Permite Intel Pentium 4 series CPU con valor de transferencia de datos de 533/ 400MHz • Permite 12 transacciones excelentes • Permite DDR333/266/200 SDRAM • AGP v2.0 Adaptable • Permite Tamaño de Ventana de Gráficos desde 4MBytes hasta 256Mbytes • Ejecuta 533MB/s de ancho de banda en 66MHz x modo 4 • Procesador 3D de alta calidad incorporado • Especificación de conformidad PCI 2.2 • Permite modo PIO 0,1,2,3,4 y DMA Compuesto modo 0,1,2 • Permite DMA Ultra 133/100/66 • Tres controladores de servidor independientes OHCI USB 1.1 y un controlador de servidor EHCI USB 2.0, permite hasta seis puertos • El sistema despertar eventos incluye: Botón de energía, Teclado contraseña/tecla atajo, alarma RTC, Modem anunciar, LAN, despertar AC'97 y despertar USB <p>Características de las teclas adicionales de la placa principal incluyen el soporte para seis puertos USB, un enlace AC' 97 para audio y modem, monitorización de hardware, y administración de energía ACPI/Encendido ahora.</p>
Memoria	<p>La placa principal permite DDR 266/333 SDRAM. Acomoda ranuras 2.5V de 184 pines sin buffer. Cada ranura soporta hasta 1 GB con una capacidad total máxima de 2 GB.</p>
USB	<p>El Controlador USB 2.0 se conforma con la Especificación de Bus Serial Universal Revisión 2.0.</p> <p>El USB 2.0 soporta los índices de transferencia de datos hasta 480MB/seg. para los dispositivos de alta velocidad y especifica un micro marco que será 1/8th de un marco de 1mseg. Esto permite que los dispositivos USB 2.0 para que tengan buffers pequeños aun en los índices de datos altos.</p> <p>Los conectores USB 1.1 y otros cables de alta velocidad pueden soportar la velocidad superior de USB 2.0 sin cambios.</p> <p>El chipset tiene las siguientes características USB avanzadas:</p> <ul style="list-style-type: none"> • Conforme con la Enhanced Host Controller Interface (EHCI) Specification Edición 0.95 y Universal Host Controller Interface (UHCI) Specification Edición 1.1

	<ul style="list-style-type: none"> • Dispositivo PCI multi-función de dos Controladores Anfitriones UHCI para la señalización de velocidad completa/baja y un Anfitrión EHCI • Soporta PCI-BUS Interfaz de Administración de Energía Especificación edición 1.1 • Soporte de legado para todos los puertos frontales inferiores
Gráficas	La placa principal incluye una ranura AGP que proporciona cinco veces el ancho de banda de la especificación AGP original. La tecnología AGP provee una conexión directa entre el subsistema de gráficos y el procesador así que el gráfico no tiene que competir por el tiempo de procesador con otros aparatos del bus del PCI.
Codec de Sonido AC'97	El codec de Sonido AC'97 se conforma con la especificación AC'97 2.2 que satisface los requisitos PC2001 y soporta S/PDIF Out. También tiene un buffer incorporado y PLL interno. Las características incluyen soporte para interruptor analógico para la salida trasera (compartir), la clavija de entrada de línea (compartir), centro/bajo (compartir), y clavija MIC para exportar sonido de 6 canales. Nota: Controlador de sonido de 4 canales optativo.
LAN Abordo (optativo)	La VT6103L es un componente Estrato Físico para Ethernet 10BASE-T y 100BASE-TX usando categoría 5 no blindado, Tipo 1 Blindado, y cables de Fibra óptica. <ul style="list-style-type: none"> • Velocidad Doble – 100/10 Mbps • Bidireccional Total y Medio • Interfaz MII para el Controlador de Ethernet • Reúne Todo lo Apropiado IEEE 802.3, 10Base-T y 100Base-Tx Convencionales
Opciones de Expansión	La placa principal viene con las siguientes opciones de expansión: <ul style="list-style-type: none"> • Dos ranuras PCI de 32 bits • Una ranura AGP • Una ranura Riser de comunicaciones y Network (CNR) (sólo interfaz AC'97) • Two IDE channels and a floppy disk drive interface La placa principal soporta al bus Ultra DMA dominando las velocidades de transferencia de 133/100/66 MB/sec.
I/O Integrado	La placa principal tiene un set completo de puertos I/O y conectores: <ul style="list-style-type: none"> • Dos puertos PS/2 para ratón y teclado • Un puerto de serie • Un puerto paralelo • Un puerto MIDI/juego • Cuatro puertos USB • Un puerto LAN • Clavijas de sonido para micrófono, en línea, fuera de línea

BIOS Firmware	<p>La placa principal usa Award BIOS que habilita a los usuarios para que configuren muchas características del sistema incluyendo las siguientes:</p> <ul style="list-style-type: none">• Administración de alimentación• Alarmas despertadores• Parámetros de CPU• Cronometraje de CPU y de memoria <p>También se puede usar el firmware para configurar los parámetros para diferentes velocidades de reloj del procesador.</p>
--------------------------	-----------------------------------------------------------------------------------------------------------------------------------------------------------------------------------------------------------------------------------------------------------------------------------------------------------------------------------------------------------------------------------------------------------------------------------------------------------------------------



Algunas especificaciones de hardware e ítems de software son sujetos a cambio sin previo aviso.

製品特徴

<p>プロセッサ</p>	<p>本メインボードに搭載されているマイクロ PGA478 ピンソケットは、次の特徴があります。</p> <ul style="list-style-type: none"> • 533/400MHz のシステムバス (FSB) をサポートします • 1.5G/1.6G/1.7G…2.5G 以上で Pentium 4 プロセッサに対応しています
<p>チップセット</p>	<p>搭載した SiS651 Northbridge および SiS962L South bridge チップセットは最新且つ拡張性あるアーキテクチャを採用し、高い安定性およびパフォーマンスを兼ね備えたものです。</p> <ul style="list-style-type: none"> • 533/400MHz のデータ通信速度で Intel Pentium 4 シリーズ CPU に対応 • 12 の優れた処理機能に対応 • DDR333/266/200 SDRAM 対応 • AGP v2.0 対応 • 4MB~256MB のグラフィック ウィンドウサイズ対応 • 66MHz x 4 モードで 533MB/秒バンド幅を実現 • 高品質 3D エンジン内蔵 • PCI 2.2 仕様準拠 • PIO モード 0、1、2、3、4 及びマルチワード DMA モード 0、1、2 対応 • Ultra DMA 133/100/66 対応 • 独立した OHCI USB 1.1 ホストコントローラ x 3 と EHCI USB 2.0 ホストコントローラ x 1 で最大 6 ポートまで対応 • システム再開イベント: 電源ボタン、キーボードパスワード/ホットキー、RTC アラーム、モデム呼び出し音、LAN、AC' 97 ウェイクアップ、USB ウェイクアップ、1394 ウェイクアップ <p>その他に、次の重要機能をサポートしています: 6 つの USB ポートをサポート、オーディオおよびモデム向けの AC' 97 リンク、ハードウェアのモニタ、および ACPI/OnNow 電源管理。</p>
<p>メモリ</p>	<p>メインボードは DDR266/333 SDRAM をサポートします。メインボードに搭載された 2 つの非バッファード 2.5V184 ピン仕様のスロットが、各々 1GB、トータルで 2GB までのメモリをサポートします。</p>
<p>USB</p>	<p>搭載している USB 2.0 コントローラは Universal Serial Bus Specification Revision 2.0 仕様に適合しています。</p> <p>USB 2.0 仕様では最大 480MB/秒までの転送速度をサポートし、1ms フレームの 1/8 になるマイクロフレームで転送を制御する。これにより、より小さいバッファードでの高速なデータ伝送が可能です。</p> <p>高速な USB2.0 のデータ伝送には、USB 1.1 向けのコネクタおよびフルスピードケーブルを直接適用することが出来ます。</p> <p>このチップセットは次の先進な USB 機能を提供します:</p>

	<ul style="list-style-type: none"> EHCI (Enhanced Host Controller Interface) 0.95 仕様および UHCI (Universal Host Controller Interface) 1.1 仕様に適合しています PCI マルチ機能デバイスは 2 つのフルスピード/ロースピード伝送用 UHCI ホストコントローラおよび 1 つの EHCI ホストで構成されています PCI バス電源管理インターフェース 1.1 仕様に適合 すべてのダウンストリームフェースポートをサポート
グラフィック	搭載されている AGP スロットは、オリジナルの AGP 仕様の 4 倍にもなる帯域幅をサポートします。AGP 技術はグラフィックサブシステムをプロセッサに直接アクセスさせることにより、PCI バスにある他のデバイスと競合せずに、プロセッサによる高速なグラフィック処理を実現するものです。
AC' 97 オーディオコーデック	AC' 97 オーディオコーデックは AC' 97 2.2 仕様に適合したもので、PC2001 要求を満たし、S/PDIF Out に対応しています。また、内蔵バッファ及び内部 PLL を搭載しています。背面アナログスイッチ (共有)、ライン入力ジャック (共有)、中央/ベース (共有)、6 チャンネルオーディオへの MIC 出力ジャックなどの機能を含みます。 メモ: オプション 4 チャンネルオーディオコントローラ
オンボード LAN 機能 (オプション)	VT6103L はカテゴリ 5 案シールド、Type 1 シールド、光ファイバーケーブルを使った Ethernet 10BASE-T と 100BASE-TX のための物理レイヤーです。 <ul style="list-style-type: none"> デュアルスピード - 100/10 Mbps に対応 半/全二重をサポート イーサネットコントローラの MII インターフェースを搭載 すべての IEEE 802.3、10Base-T、100Base-Tx 標準に対応
拡張オプション	メインボードには次に拡張オプションが搭載されています： <ul style="list-style-type: none"> 32 ビット PCI スロット x 2 AGP スロット x 1 通信ネットワークライザー (CNR) スロット (AC' 97 仕様インターフェースのみ対応) x 1 IDE チャネル x 2 およびフロッピードライブインターフェース x 1 <p>本メインボードは転送レート 133/100/66 MB/秒をサポートする Ultra DMA バスマスタ機能をお届けします。</p>
統合 I/O 機能	このメインボードにはフルセットの I/O ポートおよびコネクタが搭載しています。 <ul style="list-style-type: none"> マウスおよびキーボード用 PS/2 ポート x 2 シリアルポート x 1 VGA ポート x 1 パラレルポート x 1 USB ポート x 4 LAN ポート x 1 マイクروفोनやライン入力、ライン出力用のオーディオ

	ジャック
--	------

BIOS ファームウェア	<p>本メインボードは下記のシステム機能を含めた設定をすることができる Award BIOS を採用しています：</p> <ul style="list-style-type: none">• 電源管理• Wake-up 警告• CPU パラメータ• CPU およびメモリのタイミング <p>その他に、各種プロセッサクロック速度のパラメータを設定することができます。</p>
-------------------------	--------------------------------------------------------------------------------------------------------------------------------------------------------------------------------------------------------------------------------------



一部のハードウェア仕様及びソフトウェアアイテムは予告なく変更されることがあります。

기능

프로세서	<p>본 메인보드는 micro PGA 478 핀 소켓을 사용하며 다음과 같은 특징을 지닌다:</p> <ul style="list-style-type: none"> • 533/400 MHz frontside bus (FSB) 지원 • 1.5G/1.6G/1.7G... 3.06G 이상의 Pentium 4 프로세서 사용 3.06G
칩셋	<p>SiS651 Northbridge 과 SiS962L Southbridge 칩셋은 혁신적이고 범용성을 지닌 아키텍처를 바탕으로 인정된 신뢰성과 성능을 지닌다.</p> <ul style="list-style-type: none"> • 전송 속도 533/ 400MHz 의 Intel Pentium 4 시리즈 CPU 지원 • 12 우수한 정보 처리 지원 • DDR333/266/200 SDRAM 지원 • AGP v2.0 호환 • 4Mbytes ~ 256Mbytes 의 그래픽 윈도우 사이즈 지원 • 66MHz x 4 모드에서 533MB/s 대역폭 • 고 품질의 3D 엔진 내장 • PCI 2.2 사양 호환 • PIO 모드 0,1,2,3,4 및 Multiword DMA 모드 0,1,2 지원 • Ultra DMA 133/100/66 지원 • 3 개의 독립 OHCI USB 1.1 호스트 컨트롤러 및 1 개의 EHCI USB 2.0 호스트 컨트롤러가 최대 6 개의 포트 지원 • 시스템 wake-up 의 경우: 전원 버튼, 키보드 암호/단축키, Power button, keyboard password/hot key, RTC 알람, 모뎀 ring-in, LAN, AC' 97 wake-up, USB wake up 및 1394 wake up <p>이외에도 본 메인보드의 주요 기능으로 USB 포트 6 개, 오디오 및 모뎀용 AC' 97 링크 1 개, 하드웨어 모니터링, ACPI/OnNow 전원 관리가 있다.</p>
메모리	<p>본 메인보드는 DDR 266/333 SDRAM 을 지원한다. 2 개의 unbuffered 2.5V 184 핀 슬롯이 제공되며 각 슬롯은 최대 1 GB 를 지원하여 총 최대 용량은 2 GB 이다.</p>
USB	<p>USB 2.0 컨트롤러는 Universal Serial Bus 2.0 사양에 부합된다.</p> <p>USB 2.0 은 고속 장치를 위해 데이터 전송 속도를 최대 480MB/sec 까지 지원하고 1msec 프레임의 8 분의 1 인 마이크로 프레임을 지원함으로써, USB 2.0 장치는 고속의 데이터 속도에도 작은 버퍼를 유지할 수 있다.</p> <p>USB 1.1 커넥터와 기타 전송 케이블은 다른 변경 없이 USB 2.0 의 고속을 지원할 수 있다.</p>

	<p>이 칩셋은 다음과 같은 고급의 USB 특징을 지닌다:</p> <ul style="list-style-type: none"> Enhanced Host Controller Interface (EHCI) 0.95 사양 및 Universal Host Controller Interface (UHCI) 1.1 사양 호환 2 개의 UHCI 호스트 컨트롤러 (전속/저속 시그널링 용) 과 1 개의 EHCI 호스트 컨트롤러 코어 (고속 시그널링 용) 로 이루어진 PCI 다기능 장치 PCI-버스 전원 관리 인터페이스 1.1 사양 지원 모든 다운스트림 페이징 포트를 지원하는 Legacy
그래픽	<p>본 메인보드에는 기존 AGP 사양보다 4 배의 대역폭을 제공하는 4x AGP 슬롯이 포함되어 있다. AGP 기술은 그래픽 서브 시스템과 프로세서를 직접 연결함으로써 그래픽 프로세서 시간을 PCI 버스에 있는 다른 장치와 다툴 필요가 없다.</p>
AC' 97 오디오 코덱	<p>AC' 97 오디오 코덱은 AC' 97 2.2 사양과 호환하여 PC2001 요구 사항에 부합하며 S/PDIF Out 을 지원한다. 버퍼 및 PLL 이 내장되어 있으며, 후면-출력 (공유), 라인 입력 잭 (공유), 중앙/베이스 (공유), 및 6 채널 오디오 출력 용 MIC 잭을 위한 아날로그 스위치를 포함한다.</p> <p>노트: 선택적 4 채널 오디오 컨트롤러가 있다.</p>
보드 내장 LAN (선택 사항)	<p>VT6103L 는 카테고리 5 Unshielded, 타입 1 Shielded, 유리 섬유 케이블을 사용한 Ethernet 10BASE-T 와 100BASE-TX 를 위한 물리적 레이어 장치이다.</p> <ul style="list-style-type: none"> 듀얼 속도 - 100/10 Mbps Half 및 Full Duplex MII 인터페이스 이더넷 컨트롤러 모든 적용 가능한 IEEE 802.3, 10Base-T 및 100Base-Tx 표준 지원
확장 옵션	<p>본 메인보드에는 다음과 같은 확장 옵션이 있다:</p> <ul style="list-style-type: none"> 32-bit PCI 슬롯 2 개 AGP 슬롯 1 개 Communications and Network Riser (CNR) 슬롯 1 개 (AC' 97 인터페이스의 경우에만) IDE 채널 2 개 및 플로피 디스크 드라이브 인터페이스 1 개 <p>본 메인보드는 전송 속도 133/100/66 MB/sec 의 Ultra DMA bus mastering 을 지원한다.</p>
통합 I/O	<p>본 메인보드에는 풀 세트의 I/O 포트와 커넥터가 있다:</p> <ul style="list-style-type: none"> 마우스 및 키보드용 PS/2 포트 2 개 시리얼 포트 1 개 VGA 포트 1 개 패러럴 포트 1 개 USB 포트 4 개 LAN 포트 1 개 마이크 용 오디오 잭, 라인 입력과 라인 출력

BIOS 펌웨어	본 메인보드는 Award BIOS 를 사용하여 사용자는 다음과 같은 시스템 기능을 구성할 수 있다: <ul style="list-style-type: none">• 전원 관리• Wake-up 알람• CPU 파라미터• CPU 및 메모리 타이밍 펌웨어는 다른 프로세서의 클럭 속도를 설정하는 데도 사용될 수 있다.
---------------------	------------------------------------------------------------------------------------------------------------------------------------------------------------------------------------------------------------------------



하드웨어 사양 및 소프트웨어 아이템은 사전 통보 없이 변경될 수 있음.

性能

中央處理器	<p>本主機板採用了具有下列功能之微 PGA 478 針插槽：</p> <ul style="list-style-type: none"> • 支援 533/400MHz 的前側匯流排(FSB) • 支援 1.5G/1.6G/1.7G/3.06G 及以上之 Pentium 4 處理器
晶片組	<p>SiS651 北橋及 SiS962L 南橋晶片組，採用了獨創且具有擴充功能的架構，能夠發揮最佳的穩定性及功能。</p> <ul style="list-style-type: none"> • 支援 Intel Pentium 4 系列 CPU，位元傳輸速率高達 533/400MHz • 支援 12 個未結束傳送 (outstanding transactions) • 支援 DDR333/266/200 SDRAM • 相容於 AGP v2.0 • 支援 4 到 256 Mbytes 之圖形視窗大小 • 藉由 66MHz x4 模式，提供效能高達每秒 533MB 之頻寬 • 內建高品質 3D 立體圖像處理引擎 • 相容於 PCI 2.2 規格 • 支援 PIO mode 0,1,2,3,4 和多字元 DMA mode 0,1,2 • 支援 Ultra DMA 133/100/66 • 3 個獨立 OHCI USB 1.1 主控制器和一個 EHCI USB 2.0 主控制器，支援上至 6 埠 • 系統喚醒事件包括: 電源按鈕、鍵盤密碼/熱鍵、RTC alarm、數據機鈴響、乙太網路、AC' 97 喚醒功能和 USB 喚醒功能 <p>其他重要功能包括：支援 6 個 USB 埠、音效及數據機連接用的 AC' 97 link、硬體監視功能、及 ACPI/OnNow 電源管理功能。</p>
記憶體	<p>本主機板支援 DDR266/333 SDRAM。且，配備 2 個無緩衝 2.5V 184 針插槽，各插槽可支援 1GB，即本主機共可支援高達 2GB 的記憶體容量。</p>
USB	<p>本 USB 2.0 控制器符合通用串列匯流排 2.0 版規格。</p> <p>USB 2.0 可為高速週邊設備提供高達 480MB/sec 的資料傳輸速度及 1/8 微秒框架，使得 USB2.0 設備僅需較小的緩衝記憶體區，便可進行高速資料傳輸。</p> <p>USB 1.1 連接器及其全速連接線可直接支援更高速的 USB 2.0 規格。</p> <p>本晶片組具有以下先進的 USB 功能：</p> <ul style="list-style-type: none"> • 符合 EHCI (Enhanced Host Controller Interface) 規格 0.95 版及 UHCI (Universal Host Controller Interface) 規格 1.1 版 • PCI 多功能設備係由 2 個全/低速信號處理用 UHCI 主控制卡及 1 個 EHCI 控制卡所組成 • 支援 PCI-匯流排式 電源管理介面(Power Management Inter-

	<p>face) 規格 1.1 版</p> <ul style="list-style-type: none"> • 支援所有舊式的下行傳輸埠
繪圖卡	<p>主機板配備有一個 AGP 插槽，能夠支援為原 AGP 規格 4 倍之頻寬。AGP 技術，係使繪圖子系統與中央處理器直接連接，藉以使繪圖系統無需與 PCI 插槽上的設備，爭取處理器資源。</p>
AC' 97 音效解碼/編碼器	<p>配備之 AC' 97 音效解碼/編碼器採用了 AC' 97 2.2 規格，該規格符合 PC2001 規格要求並支援 S/PDIF 輸入/輸出。同時，本解碼/編碼器也具有內建緩衝器和內裝 PLL。藉由對後聲道輸出(共用)端子、外部音源輸入(共用)端子、中低音(共用)端子、及麥克風端子的切換功能，提供 6 聲道的音效輸出。</p> <p>附註: 可選購 4 聲道音響控制器。</p>
機載 LAN 功能 (選購)	<p>VT6103L 係為乙太 10BASE-T 和 100BASE-TX 之實體層元件，使用 Category 5(速率 100 Mbps) 無遮蔽式雙絞線，Type 1 屏蔽電纜以及光纖電纜。</p> <ul style="list-style-type: none"> • 支援雙速 - 100/10 Mbps 傳輸速率 • 支援半或全雙工運作模式 • 提供乙太網路的 MII 介面 • 適用於所有可用之 IEEE 802.3, 10BaseT 和 100Base-Tx 雙絞線, 等之標準
擴充選項	<p>本主機板具有下列的擴充選擇：</p> <ul style="list-style-type: none"> • 2 個 32 位元 PCI 插槽 • 1 個 AGP 槽 • 1 個 CNR(Communications Network Riser) 槽，AC' 97 專用介面 • 2 個 IDE 通道及 1 個軟碟介面 <p>本主機板具有之 Ultra DMA 匯流排控制功能，能夠支援 133/100/66 MB/秒的傳輸速度。</p>
整合的輸入出功能	<p>本主機板提供完整的輸出入埠及連接器：</p> <ul style="list-style-type: none"> • 2 個 PS/2 埠，分供滑鼠及鍵盤連接 • 1 個串列埠 • 1 個 VGA 埠 • 1 個平行埠 • 4 個 USB 埠 • 1 個 LAN 埠 • 麥克風、音效輸入及音效輸出端子
BIOS 韌體	<p>本主機板使用了 Award BIOS，使用者可藉此對包括下列之系統功能進行設定：</p> <ul style="list-style-type: none"> • 電源管理 • 喚醒警示 • CPU 參數 • CPU 及記憶體之定時 <p>本 BIOS 也可用以設定各種有關處理器頻率的參數。</p>



有些硬體規格以及軟體物件將視狀況適當調整，不予另行通知。

特性

處理器	<p>主板使用一个 micro PGA 478-pin 插座，此插座具有以下特点：</p> <ul style="list-style-type: none">• 支持 533/400 MHz 前端总线 (FSB)• 支持 1.5G/1.6G/1.7G/3.06G 或更高速度的 Pentium 4 处理器
芯片组	<p>SiS651 北桥和 SiS962L 南桥芯片组是基于一种新型的、可扩展的架构，能提供已经证明的可靠性和高性能。</p> <ul style="list-style-type: none">• 支持 Intel Pentium 4 系列 CPU，数据传输速率可达 533MHz• 支持 12 个未完成的事务处理• 支持 DDR333/266/200 SDRAM• AGP v2.0 兼容• 支持 4MB 到 256MB 图形窗口• 在 66MHz x 4 模式下可达 533MB/s 带宽• 内建高质量 3D 引擎• 符合 PCI 2.2 规格• 支持 PIO 模式 0、1、2、3、4 和多字节 DMA 模式 0、1、2• 支持 Ultra DMA 133/100/66• 3 个独立的 OHCI USB 1.1 主控器和 1 个 EHCI USB 2.0 主控器，可支持 6 个端口• 系统唤醒事件包括：电源按钮、键盘口令/热键、RTC 报警、调制解调器振铃、LAN、AC' 97 唤醒和 USB 唤醒 <p>其它主要功能包括支持 6 个 USB 端口、用于音频和调制解调器的 AC' 97 连接、硬件监测和 ACPI/OnNow 电源管理。</p>
内存	<p>主板支持 DDR 266/333 SDRAM。它有 2 个非缓冲 2.5V 184 pin 插槽，每个插槽支持 1 GB，总共最大可支持 2 GB。</p>
USB	<p>USB 2.0 控制器与通用串行总线规格 2.0 兼容。</p> <p>USB 2.0 支持的高速设备数据传输速率可达 480MB/sec，并指定一个 microframe (即 1msec 帧的 1/8)。这就使 USB 2.0 设备在高速数据传输速率时能够保持较小的缓冲区。</p> <p>USB 1.1 接口和其它全速电缆可支持更高速度的 USB2.0，不需要做任何修改。</p> <p>此芯片组还具备以下增强 USB 功能：</p> <ul style="list-style-type: none">• 与 0.95 版本的增强主控器接口 (EHCI) 规格和 1.1 版本的通用主控器接口 (UHCI) 规格兼容• PCI 多功能设备由 2 个用于全速/低速传输数据的 UHCI

	<p>主控器和 1 个用于高速传输数据的 EHCI 控制器组成</p> <ul style="list-style-type: none"> • 支持 1.1 版本的 PCI 总线电源管理接口规格 • 支持所有传统下行端口
图形	<p>此主板包括一个 4xAGP 插槽，可提供普通 AGP 规格 4 倍的带宽。AGP 技术能提供图像子系统和处理器之间的直接连接，这样图像就不需要与 PCI 总线上的其它设备争用处理器时间。</p>

AC' 97 Audio Codec	<p>AC' 97 音频编解码器符合 AC' 97 2.2 PC2001 规格，支持 S/PDIF Out。它还带有一个内置的缓冲器和一个内部 PLL。功能包括支持后端模拟开关（共享）、线入插孔（共享）、中置/低音（共享）和 MIC 插孔以输出 6 声道音频。</p> <p>说明： 可选 4-通道音频控制器</p>
Onboard LAN (可选)	<p>VT6103L 是一种物理层设备，可用于使用 5 类非屏蔽线、1 类屏蔽线和光缆的以太网 10BASE-T 和 100BASE-TX。</p> <ul style="list-style-type: none"> • 双速 -100/10 Mbps • 半双工和全双工 • 以太网控制器的 MII 接口 • 符合所有相应的 IEEE 802.3、10Base-T 和 100Base-Tx 标准到
扩展选项	<p>此主板提供如下扩展选项：</p> <ul style="list-style-type: none"> • 2 个 32 位 PCI 扩展插槽 • 1 个 AGP 插槽 • 1 个通信网络转接 (CNR) 插槽（仅对于 AC' 97 接口） • 2 个 IDE 通道和一个软驱接口 <p>主板支持 Ultra DMA 总线控制，传输速率可达 133/100/66 MB/sec。</p>
集成 I/O	<p>此主板具有完整的 I/O 端口和插孔：</p> <ul style="list-style-type: none"> • 2 个用于鼠标和键盘的 PS/2 端口 • 1 个串口 • 1 个 VGA 端口 • 1 个并口 • 4 个 USB 端口 • 1 个 LAN 端口 • 麦克风、线入和线出声音插孔
BIOS	<p>此主板使用 Award BIOS，可以让用户自己配置以下系统功能：</p> <ul style="list-style-type: none"> • 电源管理 • 唤醒报警 • CPU 参数 • CPU 和记忆定时 <p>还可用于设置不同处理器时钟速度的参数。</p>



部分硬件规格和软件项目若有更改恕不另行通知。

TABLE OF CONTENTS

Preface	i
Features Translations	iii
CHAPTER 1	1
Introducing the Motherboard	1
<i>Introduction</i>	1
<i>Features</i>	2
<i>Choosing a Computer Case</i>	4
<i>Motherboard Components</i>	5
CHAPTER 2	7
Installing the Motherboard	7
<i>Safety Precautions</i>	7
<i>Quick Guide</i>	7
<i>Installing the Motherboard in a Case</i>	8
<i>Checking Jumper Settings</i>	8
Setting Jumpers	8
Checking Jumper Settings	9
Jumper Settings	9
<i>Connecting Case Components</i>	10
Front Panel Connector	12
<i>Installing Hardware</i>	13
Installing the Processor	13
Installing Memory Modules	16
Installing a Hard Disk Drive/CD-ROM	17
Installing a Floppy Diskette Drive	19
Installing Add-on Cards	20
Connecting Optional Devices	22
<i>Connecting I/O Devices</i>	24
CHAPTER 3	25
Using BIOS	25
<i>About the Setup Utility</i>	25
The Standard Configuration	25

Entering the Setup Utility	26
Updating the BIOS	26
<i>Using BIOS</i>	27
Standard CMOS Features	28
Advanced BIOS Features	30
Advanced Chipset Features	33
Integrated Peripherals	35
Power Management Setup	39
PNP/PCI Configurations	43
PC Health Status	44
Frequency/Voltage Control	44
Load Fail-Safe Defaults Option	46
Load Optimized Defaults Option	46
Set Supervisor/User Password	47
Save & Exit Setup Option	47
Exit Without Saving	47

CHAPTER 4 **48**

Using the Motherboard Software	48
<i>About the Software CD-ROM</i>	48
<i>Auto-installing under Windows 98/ME/2000/XP</i>	48
Running Setup	49
<i>Manual Installation</i>	51
<i>Utility Software Reference</i>	51

Chapter 1

Introducing the Motherboard

Introduction

Thank you for choosing the L4S5MG3/651+ motherboard. This micro-ATX motherboard comes with the high performance SiS651 Northbridge and SiS962L Southbridge chipsets. It accommodates Intel Pentium 4 processors, which supports a frontside bus (FSB) speeds up to 533/400 MHz.

The SiS651 Northbridge provides a high performance 2D/3D Graphic Engine, Video Accelerator and Advanced Hardware Acceleration MPEGI/MPEGII Video Decoder for the Intel Pentium 4 series based PC systems. It offers bandwidth up to 2.7GB/s under DDR333, 2GB/s under DDR266 and 1GB/s under PC 133 in order to sustain the bandwidth demand from host processor, as well as the multi I/O masters and AGP masters.

The SiS962L Southbridge integrates one Universal Serial Bus 2.0 Host Controllers, audio controller with AC'97 interface, Ethernet MAC controller with standard MII interface, three Universal Serial Bus 1.1 Host Controllers and the IDE Master/Slave controllers.

The motherboard has an advanced full set of I/O ports, such as dual channel IDE interfaces, a floppy controller, a high-speed serial port, a VGA port, an EPP/ECP capable bi-directional parallel port connector, four USB (Universal Serial Bus) connector, a PS/2 keyboard connector, mouse connector and audio jacks for microphone, line-in, line-out. One AGP slot, three PCI local bus slots and one communication and networking riser (CNR) slot provide expandability for add-on peripheral cards.

Featuring good stability and performance, and the advanced SiS chipset, the L4S5MG3/651+ is an excellent Pentium 4 DDR motherboard for the budget-conscious consumer. It is the ideal solution for any home or workstation PC.

Features

Processor	<p>The motherboard uses a micro PGA 478-pin socket that has the following features:</p> <ul style="list-style-type: none"> • Supports 533/400 MHz frontside bus (FSB) • Accommodates Pentium 4 processors at 1.5G/1.6G/1.7G ...3.06G and above
Chipset	<p>The SiS651 Northbridge and SiS962L Southbridge chipsets are based on an innovative and scalable architecture with proven reliability and performance.</p> <ul style="list-style-type: none"> • Support Intel Pentium 4 series CPU with data transfer rate of 533/400MHz • Support 12 outstanding transactions • Supports DDR333/266/200 SDRAM • AGP v2.0 Compliant • Supports Graphic Window Size from 4MBytes to 256Mbytes • Perform 533MB/s bandwidth in 66MHz x 4 mode • Built-in a high quality 3D engine • PCI 2.2 specification compliance • Supports PIO mode 0,1,2,3,4 and Multiword DMA mode 0,1,2 • Supports Ultra DMA 133/100/66 • Three independent OHCI USB 1.1 host controllers and one EHCI USB 2.0 host controller, support up to six ports • System wake-up events include: Power button, keyboard password/hot key, RTC alarm, Modem ring-in, LAN, AC'97 wake-up, USB wake up and 1394 wake up <p>Additional key features of the motherboard include support for six USB ports, an AC' 97 link for audio and modem, hardware monitoring, and ACPI/OnNow power management.</p>
Memory	<p>The motherboard supports DDR 333/266 SDRAM. It accommodates two unbuffered 2.5V 184-pin slots. Each slot supports up to 1 GB with a total maximum capacity of 2 GB.</p>
Graphics	<p>The motherboard includes an AGP slot that provides four times the bandwidth of the original AGP specification. AGP technology provides a direct connection between the graphics sub-system and the processor so that the graphics do not have to compete for processor time with other devices on the PCI bus.</p>
USB	<p>The USB 2.0 Controller is compliant with Universal Serial Bus Specification Revision 2.0.</p> <p>The USB 2.0 supports data transfer rates up to 480MB/sec for high-speed devices and specifies a microframe that will be 1/8th of a 1msec frame. This allows the USB 2.0 devices to have small buffers even at high data rates.</p> <p>The USB 1.1 connectors and other full speed cables can support the higher speed of USB 2.0 without any changes.</p> <p>The chipset has the following advanced USB features:</p> <ul style="list-style-type: none"> • Compliant with Enhanced Host Controller Interface (EHCI) Specification Revision 0.95 and Universal Host Controller Interface (UHCI) Specification Revision 1.1

	<ul style="list-style-type: none"> • PCI multi-function device consists of two UHCI Host Controllers for full/low-speed signaling and one EHCI Host Controller core for high-speed signaling • Supports PCI-Bus Power Management Interface Specification release 1.1 • Legacy support for all downstream facing ports
AC' 97 Audio CODEC	<p>The AC' 97 Audio CODEC is compliant with the AC'97 2.2 specification that meets the PC2001 requirements and supports S/PDIF Out. It also has a built-in buffer and internal PLL. Features include support for analog switch for rear-out (share), the line-in jack (share), center/bass (share), and MIC jack to output 6 channels audio.</p> <p>Note: Optional 4-channel audio controller.</p>
Onboard LAN (optional)	<p>The Onboard LAN is a Physical Layer device for Ethernet 10BASE-T and 100BASE-TX using category 5 Unshielded, Type 1 Shielded, and Fiber Optic cables.</p> <ul style="list-style-type: none"> • Dual Speed – 100/10 Mbps • Half And Full Duplex • MII interface to Ethernet Controller • Meet all applicable IEEE802.3, 10Base-T and 100Base-Tx standards
Expansion Options	<p>The motherboard comes with the following expansion options:</p> <ul style="list-style-type: none"> • Three 32-bit PCI slots • One AGP slot • A Communications and Network Riser (CNR) slot (AC'97 interface only) • Two IDE channels and a floppy disk drive interface <p>The motherboard supports Ultra DMA bus mastering with transfer rates of 133/100/66 MB/sec.</p>
Integrated I/O	<p>The motherboard has a full set of I/O ports and connectors:</p> <ul style="list-style-type: none"> • Two PS/2 ports for mouse and keyboard • One serial port • One VGA port • One parallel port • Four USB ports • One LAN port • Audio jacks for microphone, line-in and line-out
BIOS Firmware	<p>This motherboard uses Award BIOS that enables users to configure many system features including the following:</p> <ul style="list-style-type: none"> • Power management • Wake-up alarms • CPU parameters • CPU and memory timing <p>The firmware can also be used to set parameters for different processor clock speeds.</p>



Some hardware specifications and software items are subject to change without prior notice.

Choosing a Computer Case

There are many types of computer cases on the market. The motherboard complies with the specifications for the Micro ATX system case. Some features on the motherboard are implemented by cabling connectors on the motherboard to indicators and switches on the system case. Ensure that your case supports all the features required. The motherboard can support one or two floppy diskette drives and four enhanced IDE drives. Ensure that your case has sufficient power and space for all the drives that you intend to install.

Most cases have a choice of I/O templates in the rear panel. Make sure that the I/O template in the case matches the I/O ports installed on the rear edge of the motherboard.

This motherboard has a Micro ATX form factor of 244 x 220 mm. Choose a case that accommodates this form factor.

Motherboard Components

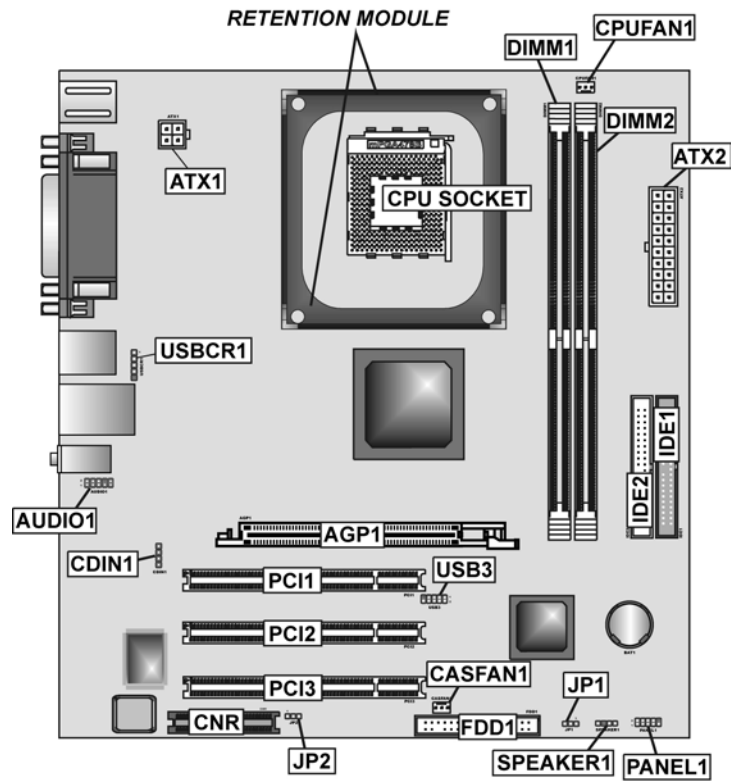

Table of Motherboard Components

Label	Component
AGP1	Accelerated Graphics Port
ATX1	Auxiliary power connector for Pentium 4 CPUs
ATX2	Standard 20-pin ATX power connector
AUDIO1	Front audio connector
CASFAN1	Case fan connector 1
CDIN1	Primary CD-in connector
CNR1	Communications Networking Riser slot
CPU SOCKET	Micro PGA 478-pin socket for Pentium 4 CPUs
CPUFAN1	Cooling fan for CPU
DIMM1 ~ DIMM2	Two 184-pin DDR SDRAM
FDD1	Floppy disk drive connector
IDE 1	Primary IDE channel
IDE 2	Secondary IDE channel
JP1	Clear CMOS jumper
JP2	BIOS protection jumper
PANEL1	Connector for case front panel switches and LED indicators
PCI1 ~ PCI3	Three 32-bit add-on card slots
SPEAKER1	Speaker connector
USB3	Front panel USB headers
USBCR1	USB Card Reader header

This concludes Chapter 1. The next chapter explains how to install the motherboard.

Chapter 2

Installing the Motherboard

Safety Precautions

Follow these safety precautions when installing the motherboard:

- Wear a grounding strap attached to a grounded device to avoid damage from static electricity.
- Discharge static electricity by touching the metal case of a safely grounded object before working on the motherboard.
- Leave components in the static-proof bags they came in.
- Hold all circuit boards by the edges. Do not bend circuit boards.

Quick Guide

This Quick Guide suggests the steps you can take to assemble your system with the motherboards.

The following table provides a reference for installing specific components:

Locating Motherboard Components	Go to page 5
Installing the Motherboard in a Case	Go to page 8
Setting Jumpers	Go to page 8
Installing Case Components	Go to page 10
Installing the Processor	Go to page 13
Installing Memory	Go to page 16
Installing a HDD and CD-ROM Drive	Go to page 17
Installing an FDD	Go to page 19
Installing Add-on Cards	Go to page 20
Connecting Optional Devices	Go to page 22
Connecting Peripheral (I/O) Devices	Go to page 24

Installing the Motherboard in a Case

Refer to the following illustration and instructions for installing the motherboard in a case:

This illustration shows an example of a motherboard being installed in a tower-type case:

Note: Do not overtighten the screws as this can stress the motherboard.

Most system cases have mounting brackets installed in the case, which correspond to the holes in the motherboard. Place the motherboard over the mounting brackets and secure the motherboard onto the mounting brackets with screws.

2. Secure the mainboard with screws where appropriate.

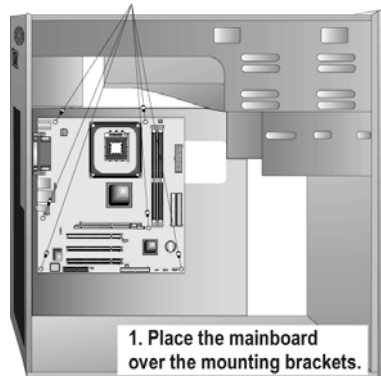

Ensure that your case has an I/O template that supports the I/O ports and expansion slots on your motherboard.

Checking Jumper Settings

This section explains how to set jumpers for correct configuration of the motherboard.

Setting Jumpers

Use the motherboard jumpers to set system configuration options. Jumpers with more than one pin are numbered. When setting the jumpers, ensure that the jumper caps are placed on the correct pins.

The illustrations below show a 2-pin jumper. When the jumper cap is placed on both pins, the jumper is SHORT. If you remove the jumper cap, or place the jumper cap on just one pin, the jumper is OPEN.

This illustration shows a 3-pin jumper. Pins 1 and 2 are SHORT.

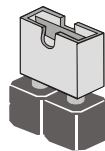

Short

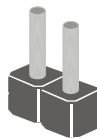

Open

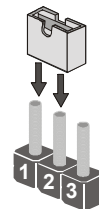

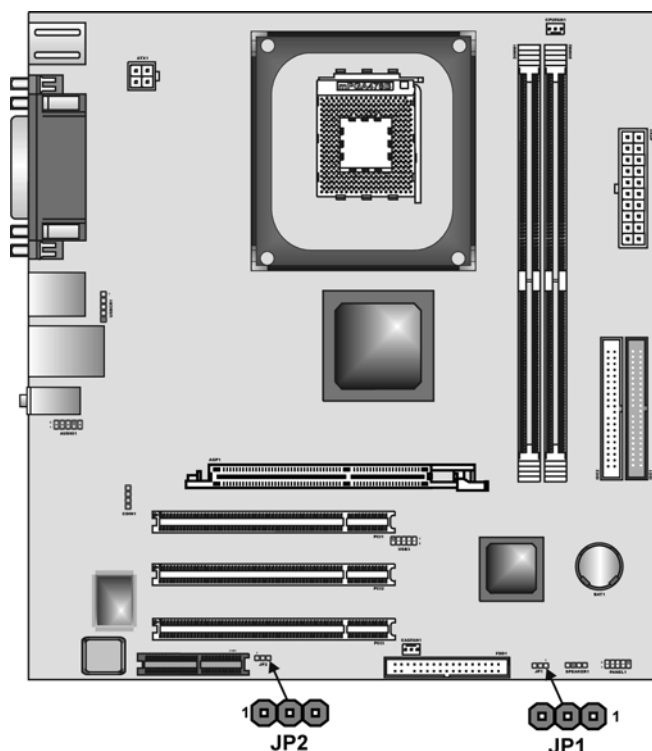

Checking Jumper Settings

The following illustration shows the location of the motherboard jumpers. Pin 1 is labeled.



Jumper Settings

Jumper	Type	Description	Setting (default)
JP1	3-pin	Clear CMOS	1-2: Normal 2-3: <i>Clear</i> Before cleaning the CMOS, make sure to turn the system off. 
JP2	3-pin	BIOS protect	1-2: Write Enabled 2-3: <i>Write Disabled</i> 

Connecting Case Components

After you have installed the motherboard into a case, you can begin connecting the motherboard components. Refer to the following:

<ol style="list-style-type: none"> 1. Connect the CPU cooling fan cable to CPUFAN1. 2. Connect the case cooling fan connector to CASFAN1. 3. Connect the case speaker cable to SPEAKER1. 4. Connect the case switches and indicator to PANEL1. 5. Connect the Pentium 4 processor auxiliary case power supply connector to ATX1. 6. Connect the standard power supply connector to ATX2. 	<p>The diagram shows a motherboard with several connectors labeled: ATX1 (top left), CPUFAN1 (top right), CASFAN1 (bottom left), SPEAKER1 (bottom center), and PANEL1 (bottom right). Each connector is shown with its respective pin configuration and a small icon representing the component it connects.</p>
------------------------------------------------------------------------------------------------------------------------------------------------------------------------------------------------------------------------------------------------------------------------------------------------------------------------------------------------------------------------------------------------------------------------------------------------------------------------------------------------	------------------------------------------------------------------------------------------------------------------------------------------------------------------------------------------------------------------------------------------------------------------------------------------------------------------

CPUFAN1/CASFAN1:FAN Power Connectors

Pin	Signal Name	Function
1	GND	System Ground
2	+12V	Power +12V
3	Sense	Sensor

SPEAKER1: Internal speaker

Pin	Signal Name
1	Signal
2	Key
3	Ground
4	VCC

ATX1: ATX 12V Power Connector

Pin	Signal Name
1	+12V
2	+12V
3	Ground
4	Ground

ATX2: ATX 20-pin Power Connector

Pin	Signal Name	Pin	Signal Name
1	+3.3V	11	+3.3V
2	+3.3V	12	-12V
3	Ground	13	Ground
4	+5V	14	PS ON#
5	Ground	15	Ground
6	+5V	16	Ground
7	Ground	17	Ground
8	PWRGD	18	-5V
9	+5VSB	19	+5V
10	+12V	20	+5V

Front Panel Connector

The front panel connector (PANEL1) provides a standard set of switch and LED connectors commonly found on ATX or micro-ATX cases. Refer to the table below for information:

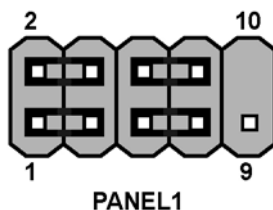

Pin	Signal	Function	Pin	Signal	Function
1	HD_LED_P	Hard disk LED (positive)	2	FP PWR/SLP	MSG LED [dual color or single color (+)]
3	HD_LED_N	Hard disk active LED (negative)	4	FP PWR/SLP	MSG LED [dual color or single color (-)]
5	RST_SW_N	Reset Switch	6	PWR_SW_P	Power Switch
7	RST_SW_P	Reset Switch	8	PWR_SW_N	Power Switch
9	RSVD	Reserved	10	NC	No pin

Hard Drive Activity LED

Connecting pins 1 and 3 to a front panel mounted LED provides visual indication that data is being read from or written to the hard drive. For the LED to function properly, an IDE drive should be connected to the onboard IDE interface. The LED will also show activity for devices connected to the SCSI (hard drive activity LED) connector.

Power / Sleep / Message Waiting LED

Connecting pins 2 and 4 to a single- or dual-color, front panel mounted LED provides power on/off, sleep, and message waiting indication.

Reset Switch

Supporting the reset function requires connecting pins 5 and 7 to a momentary-contact switch that is normally open. When the switch is closed, the board resets and runs POST.

Power Switch

Supporting the power on/off function requires connecting pins 6 and 8 to a momentary-contact switch that is normally open. The switch should maintain contact for at least 50 ms to signal the power supply to switch on or off. The time requirement is due to internal debounce circuitry. After receiving a power on/off signal, at least two seconds elapses before the power supply recognizes another on/off signal.

Installing Hardware

Installing the Processor

Caution: When installing a CPU heatsink and cooling fan make sure that you **DO NOT** scratch the motherboard or any of the surface-mount resistors with the clip of the cooling fan. If the clip of the cooling fan scrapes across the motherboard, you may cause serious damage to the motherboard or its components.

On most motherboards, there are small surface-mount resistors near the processor socket, which may be damaged if the cooling fan is carelessly installed.

Avoid using cooling fans with sharp edges on the fan casing and the clips. Also, install the cooling fan in a well-lit work area so that you can clearly see the motherboard and processor socket.

Before installing the Processor

This motherboard automatically determines the CPU clock frequency and system bus frequency for the processor. You may be able to change these settings by making changes to jumpers on the motherboard, or changing the settings in the system Setup Utility. We strongly recommend that you do not overclock processors or other components to run faster than their rated speed.

Warning: Overclocking components can adversely affect the reliability of the system and introduce errors into your system. Overclocking can permanently damage the motherboard by generating excess heat in components that are run beyond the rated limits.

This motherboard has a Socket 478 processor socket. When choosing a processor, consider the performance requirements of the system. Performance is based on the processor design, the clock speed and system bus frequency of the processor, and the quantity of internal cache memory and external cache memory.

CPU Installation Procedure

The following illustration shows CPU installation components:

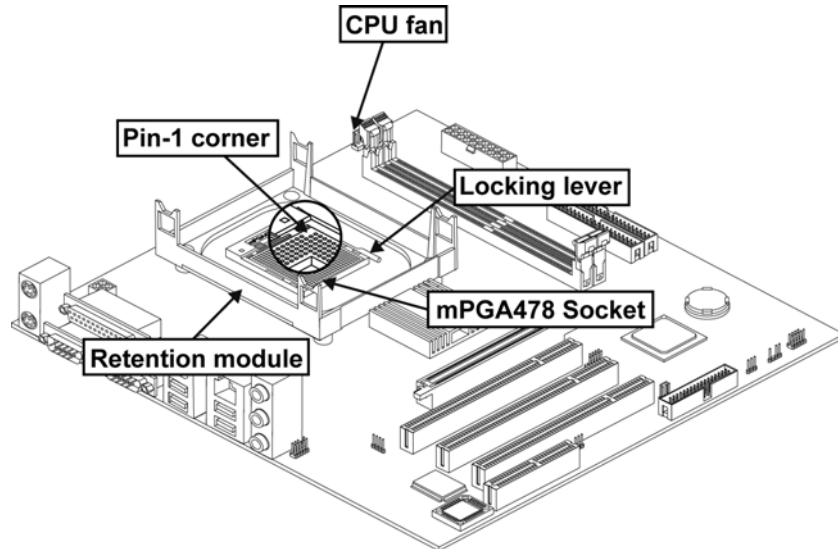

Note: The pin-1 corner is marked with an arrow ▼

Follow these instructions to install the Retention Module and CPU:

1. Install your CPU. Pull up the lever away from the socket and lift up to 90-degree angle.

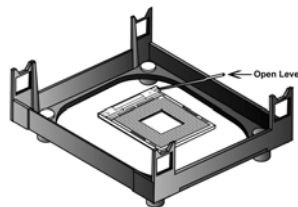

2. Locate the CPU cut edge (the corner with the pinhole noticeably missing). Align and insert the CPU correctly.

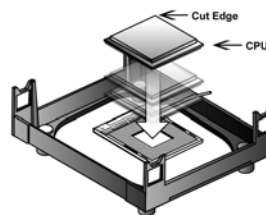

3. Press the lever down.

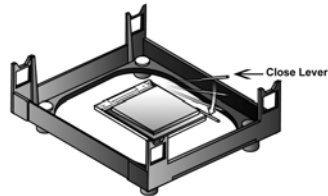

4. Apply thermal grease on top of the CPU.

5. Put the CPU Fan down on the retention module and snap the four retention legs of the cooling fan into place.

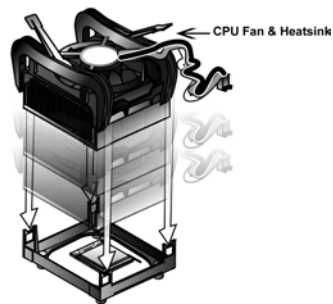

6. Flip the levers over to lock the heat sink in place.

7. Connect the CPU Cooling Fan power cable to the CPUFAN1 connector. This completes the installation.

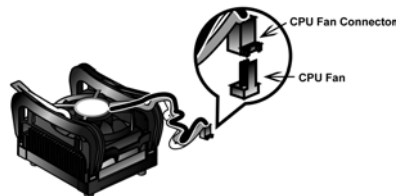

- Notes:**
- To achieve better airflow rates and heat dissipation, we suggest that you use a high quality fan with 4800 rpm at least.
 - CPU fan and heatsink installation procedures may vary with the type of CPU fan/heatsink supplied. The form and size of fan/heatsink may also vary.

Installing Memory Modules

This motherboard accommodates 184-pin 2.5V unbuffered Double Data Rate (DDR) SDRAM memory modules. The memory chips must be standard or registered SDRAM (Synchronous Dynamic Random Access Memory). The memory bus runs at 166 MHz.

Note: SDRAM provides 800 MBps or 1 GBps data transfer depending on whether the bus is 100MHz or 133MHz. Double Data Rate SDRAM (DDR SDRAM) doubles the rate to 1.6 GBps and 2.1 GBps. DDR SDRAM uses additional power and ground lines and requires 184-pin DIMM modules rather than the 168-pin DIMMs used by SDRAM.

The motherboard accommodates two memory modules. You must install at least one module in any of the two slots. Each module can be installed with 32 MB to 1 GB of memory; total memory capacity is 2 GB.



Do not remove any memory module from its antistatic packaging until you are ready to install it on the motherboard. Handle the modules only by their edges. Do not touch the components or metal parts. Always wear a grounding strap when you handle the modules.

Refer to the following to install the memory modules.

1. This motherboard supports unbuffered DDR SDRAM only. Do not attempt to insert any other type of DDR SDRAM into the slots.

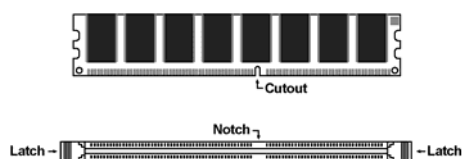

2. Push the latches on each side of the DIMM slot down.
3. Align the memory module with the slot. The DIMM slots are keyed with notches and the DIMMs are keyed with cutouts so that they can only be installed correctly.

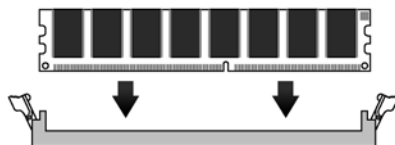

4. Check that the cutouts on the DIMM module edge connector match the notches in the DIMM slot.
5. Install the DIMM module into the slot and press it firmly down until it seats correctly. The slot latches are levered upwards and latch on to the edges of the DIMM.



6. Install any remaining DIMM modules.

Installing a Hard Disk Drive/CD-ROM

This section describes how to install IDE devices such as a hard disk drive and a CD-ROM drive.

Your motherboard has a primary and secondary IDE channel interface (IDE1 and IDE2). An IDE ribbon cable supporting two IDE devices is bundled with the motherboard.

If you want to install more than two IDE devices, get a second IDE cable and you can add two more devices to the secondary IDE channel.



You must orient the cable connector so that the pin 1 (color) edge of the cable corresponds to the pin 1 of the I/O port connector.

IDE1: Primary IDE Connector

The first hard drive should always be connected to IDE1.

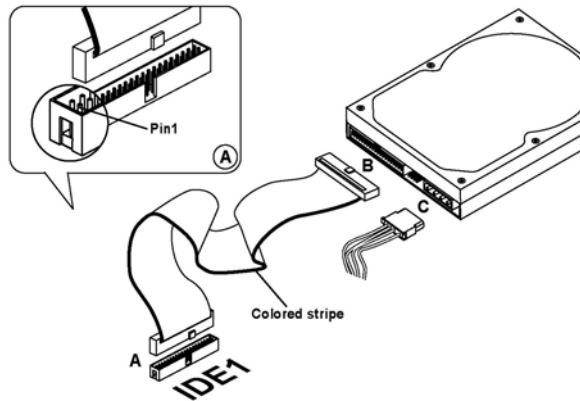

IDE2: Secondary IDE

The second drive on this controller must be set to slave mode. The configuration is the same as IDE1.

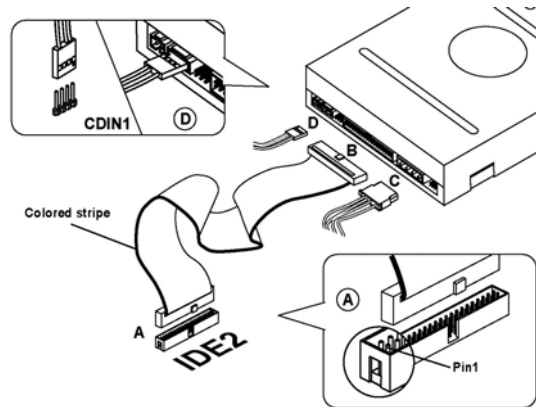

IDE devices have jumpers or switches that are used to set the IDE device as MASTER or SLAVE. Refer to the IDE device user's manual. When installing two IDE devices on one cable, ensure that one device is set to MASTER and the other device is set to SLAVE. The documentation of your IDE device explains how to do this.

About UltraDMA

This motherboard supports UltraDMA 133/100/66. UDMA is a technology that accelerates the performance of devices in the IDE channel. To maximize performance, install IDE devices that support UDMA and use 80-pin IDE cables that support UDMA 133/100/66.

Installing a Floppy Diskette Drive

The motherboard has a floppy diskette drive (FDD) interface and ships with a diskette drive ribbon cable that supports one or two floppy diskette drives. You can install a 5.25-inch drive and a 3.5-inch drive with various capacities. The floppy diskette drive cable has one type of connector for a 5.25-inch drive and another type of connector for a 3.5-inch drive.



You must orient the cable connector so that the pin 1 (color) edge of the cable corresponds to the pin 1 of the I/O port connector.

FDD1: Floppy Disk Connector

This connector supports the provided floppy drive ribbon cable. After connecting the single end to the onboard floppy connector, connect the remaining plugs on the other end to the floppy drives correspondingly.

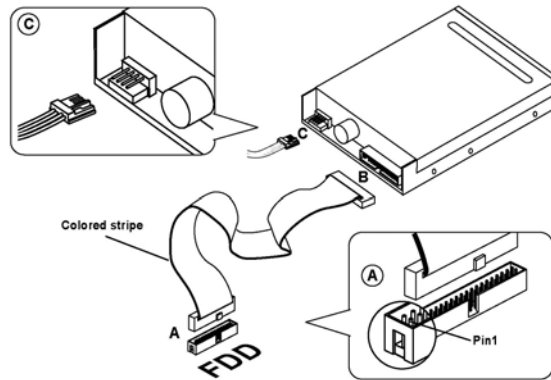

Installing Add-on Cards

The slots in this motherboard are designed to hold expansion cards and connect them to the system bus. Expansion slots are a means of adding or enhancing the motherboard's features and capabilities. With these efficient facilities, you can increase the motherboard's capabilities by adding hardware which performs tasks that are not part of the basic system.

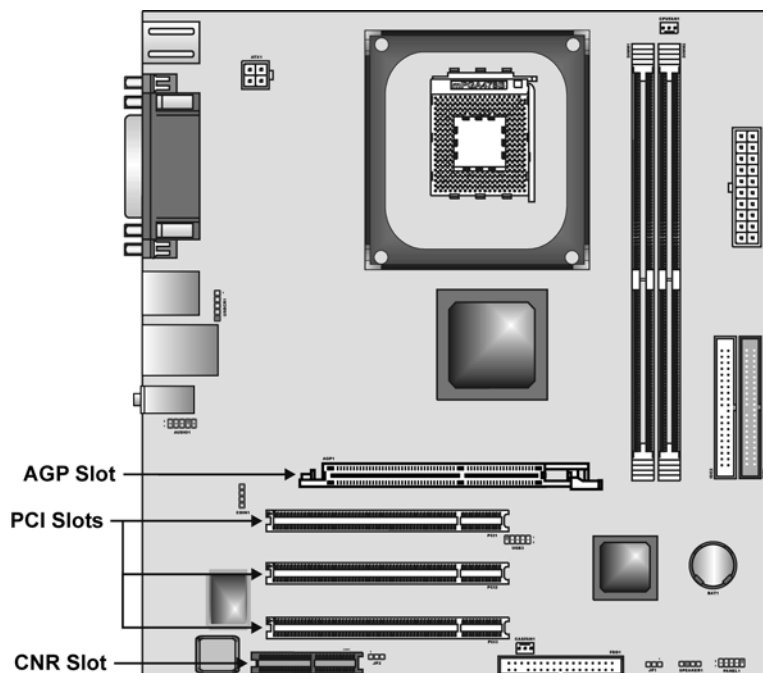

- AGP Slot** The AGP slot is used to install a graphics adapter that supports the AGP 4X specification and has a AGP 4X edge connector.
- PCI Slots** PCI slots are used to install expansion cards that have the 32-bit PCI interface.
- CNR Slot** This slot is used to insert CNR cards with Modem and Audio functionality.

Note: Before installing an add-on card, check the documentation for the card carefully. If the card is not Plug and Play, you may have to manually configure the card before installation.

Follow these instructions to install an add-on card:

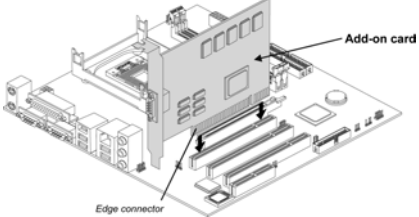
1. Remove a blanking plate from the system case corresponding to the slot you are going to use.	
2. Install the edge connector of the add-on card into the expansion slot. Ensure that the edge connector is correctly seated in the slot.	
3. Secure the metal bracket of the card to the system case with a screw.	

Note: For some add-on cards, for example graphics adapters and network adapters, you have to install drivers and software before you can begin using the add-on card.

Connecting Optional Devices

Refer to the following for information on connecting the motherboard's optional devices:

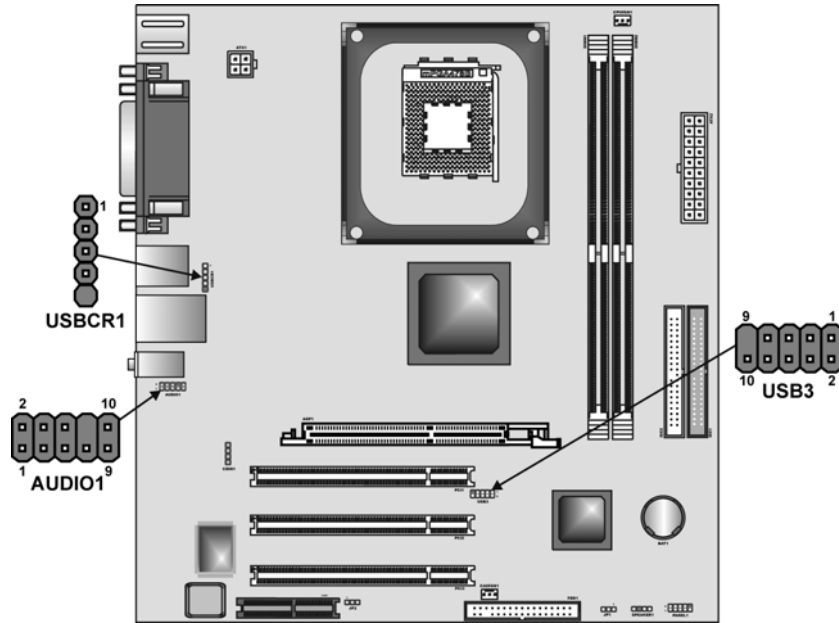

AUDIO1: Front Panel Audio header

This header allows the user to install auxiliary front-oriented microphone and line-out ports for easier access.

Pin	Signal Name	Function
1	AUD_MIC	Front Panel Microphone input signal
2	AUD_GND	Ground used by Analog Audio Circuits
3	AUD_MIC_BIAS	Microphone Power
4	AUD_VCC	Filtered +5 V used by Analog Audio Circuits
5	AUD_FPOUT_R	Right Channel Audio signal to Front Panel
6	AUD_RET_R	Right Channel Audio signal to Return from Front Panel
7	HP_ON	Reserved for future use to control Head-phone Amplifier
8	KEY	No Pin
9	AUD_FPOUT_L	Left Channel Audio signal to Front Panel
10	AUD_RET_L	Left Channel Audio signal Return from Front Panel

USB3: Front panel USB ports

The motherboard has two USB ports installed on the rear edge I/O port array. Additionally, some computer cases have USB ports at the front of the case. If you have this kind of case, use auxiliary USB connector USB3 to connect the front-mounted ports to the motherboard.

Pin	Signal Name	Function
1	VREG_FP_USBPOWER0	Front Panel USB Power
2	VREG_FP_USBPOWER0	Front Panel USB Power
3	USB_FP_P0-	USB Port 0 Negative Signal
4	USB_FP_P1-	USB Port 1 Negative Signal
5	USB_FP_P0+	USB Port 0 Positive Signal
6	USB_FP_P1+	USB Port 1 Positive Signal
7	GND	Ground
8	GND	Ground
9	KEY	No pin
10	USB_FP_OC0	Overcurrent signal

Note: Please make sure that the USB cable has the same pin assignment as indicated above. A different pin assignment may cause damage or system hang-up.

USBCR1: USB Card Reader connector

This connector is for connecting internal USB card reader. You can use a card reader to read or transfer files and digital images to your computer.

Pin	Signal Name	Function
1	USBVCC2	+5V dual
2	USB2-	Data signal port 2-
3	USB2+	Data signal port 2+
4	GND	Ground
5	Key	No pin

Note: The USBCR1 is shared with one of the USB ports of the I/O back panel. See “Connecting I/O Devices” for more information.



Please check the pin assignment of the cable and the USB header on the motherboard. Make sure the pin assignment will match before plugging in. Any incorrect usage may cause unexpected damage to the system.

Connecting I/O Devices

The backplane of the motherboard has the following I/O ports:

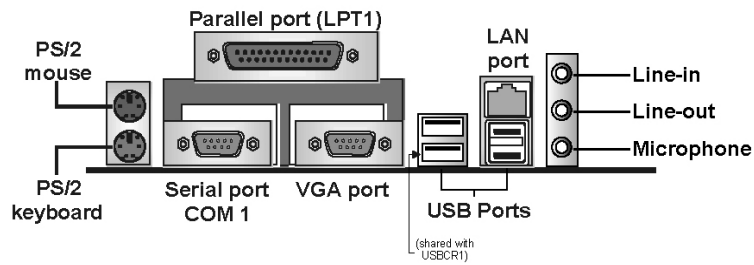

- | | |
|----------------------|-----------------------------------------------------------------------------------------------------------------------------------------------------------------------------------|
| PS/2 Mouse | Use the upper PS/2 port to connect a PS/2 pointing device. |
| PS/2 Keyboard | Use the lower PS/2 port to connect a PS/2 keyboard. |
| LPT1 | Use LPT1 to connect printers or other parallel communications devices. |
| COM1 | Use the COM ports to connect serial devices such as mice or fax/modems. COM1 is identified by the system as COM1/3. |
| VGA Port | Connect your monitor to the VGA port. |
| Audio Ports | Use the three audio ports to connect audio devices. The first jack is for stereo line-in signal. The second jack is for stereo line-out signal. The third jack is for microphone. |
| LAN Port | Connect an RJ-45 jack to the LAN port to connect your computer to the Network. |
| USB Ports | Use the USB ports to connect USB devices. |

This concludes Chapter 2. The next chapter covers the BIOS.

Chapter 3

Using BIOS

About the Setup Utility

The computer uses the latest Award BIOS with support for Windows Plug and Play. The CMOS chip on the motherboard contains the ROM setup instructions for configuring the motherboard BIOS.

The BIOS (Basic Input and Output System) Setup Utility displays the system's configuration status and provides you with options to set system parameters. The parameters are stored in battery-backed-up CMOS RAM that saves this information when the power is turned off. When the system is turned back on, the system is configured with the values you stored in CMOS.

The BIOS Setup Utility enables you to configure:

- Hard drives, diskette drives, and peripherals
- Video display type and display options
- Password protection from unauthorized use
- Power management features

The settings made in the Setup Utility affect how the computer performs. Before using the Setup Utility, ensure that you understand the Setup Utility options.

This chapter provides explanations for Setup Utility options.

The Standard Configuration

A standard configuration has already been set in the Setup Utility. However, we recommend that you read this chapter in case you need to make any changes in the future.

This Setup Utility should be used:

- when changing the system configuration
- when a configuration error is detected and you are prompted to make changes to the Setup Utility
- when trying to resolve IRQ conflicts
- when making changes to the Power Management configuration
- when changing the password or making other changes to the Security Setup

Entering the Setup Utility

When you power on the system, BIOS enters the Power-On Self Test (POST) routines. POST is a series of built-in diagnostics performed by the BIOS. After the POST routines are completed, the following message appears:

Press DEL to enter SETUP

Pressing the delete key  accesses the BIOS Setup Utility:

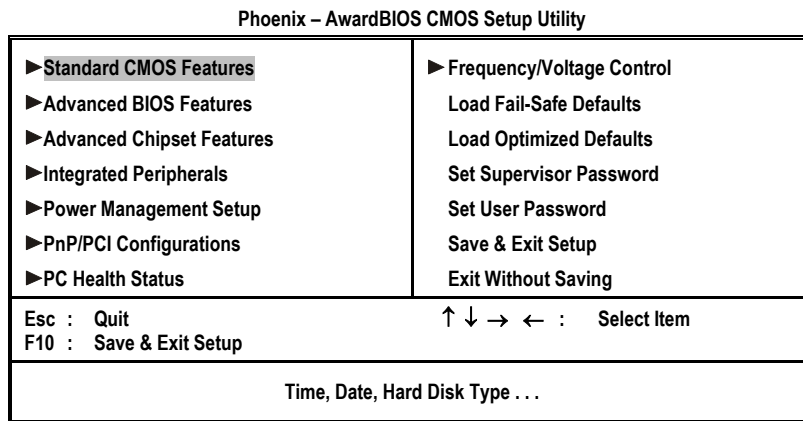

BIOS Navigation Keys

The BIOS navigation keys are listed below:

Key	Function
Esc	Exits the current menu
←↑↓→	Scrolls through the items on a menu
+/-/PU/PD	Modifies the selected field's values
F10	Saves the current configuration and exits setup
F1	Displays a screen that describes all key functions
F5	Loads previously saved values to CMOS
F6	Loads a minimum configuration for troubleshooting.
F7	Loads an optimum set of values for peak performance

Updating the BIOS

You can download and install updated BIOS for this motherboard from the manufacturer's Web site. New BIOS provides support for new peripherals, improvements in performance, or fixes for known bugs. Install new BIOS as follows:

1. If your motherboard has a BIOS protection jumper, change the setting to allow BIOS flashing.

2. If your motherboard has an item called Firmware Write Protect in Advanced BIOS features, disable it. (Firmware Write Protect prevents BIOS from being overwritten.)
3. Create a bootable system disk. (Refer to Windows online help for information on creating a bootable system disk.)
4. Download the Flash Utility and new BIOS file from the manufacturer's Web site. Copy these files to the system diskette you created in Step 3.
5. Turn off your computer and insert the system diskette in your computer's diskette drive. (You might need to run the Setup Utility and change the boot priority items on the Advanced BIOS Features Setup page, to force your computer to boot from the floppy diskette drive first.)
6. At the A:\ prompt, type the Flash Utility program name and press <Enter>.
7. Type the filename of the new BIOS in the "File Name to Program" text box. Follow the onscreen directions to update the motherboard BIOS.
8. When the installation is complete, remove the floppy diskette from the diskette drive and restart your computer. If your motherboard has a Flash BIOS jumper, reset the jumper to protect the newly installed BIOS from being overwritten.

Using BIOS

When you start the Setup Utility, the main menu appears. The main menu of the Setup Utility displays a list of the options that are available. A highlight indicates which option is currently selected. Use the cursor arrow keys to move the highlight to other options. When an option is highlighted, execute the option by pressing <Enter>.

Some options lead to pop-up dialog boxes that prompt you to verify that you wish to execute that option. Other options lead to dialog boxes that prompt you for information.

Some options (marked with a triangle ►) lead to submenus that enable you to change the values for the option. Use the cursor arrow keys to scroll through the items in the submenu.

In this manual, default values are enclosed in parenthesis. Submenu items are denoted by a triangle ►.

Standard CMOS Features

This option displays basic information about your system.

Phoenix – AwardBIOS CMOS Setup Utility Standard CMOS Features

Date (mm:dd:yy)	Tue, July 11 2001	Item Help
Time (hh:mm:ss)	12 : 8 : 59	
▶ IDE Primary Master		Menu Level ▶
▶ IDE Primary Slave		Change the day, month, year and century.
▶ IDE Secondary Master		
▶ IDE Secondary Slave		
Drive A	[1.44M, 3.5 in.]	
Drive B	[None]	
Floppy 3 Mode Support	[Disabled]	
Video	[EGA/VGA]	
Halt On	[All Errors]	
Base Memory	640K	
Extended Memory	31744K	
Total Memory	32768K	

↑↓ → ← : Move Enter : Select +-/PU/PD:Value: F10: Save ESC: Exit F1:General Help
F5:Previous Values F6:Fail-Safe Defaults F7:Optimized Defaults

Date and Time

The Date and Time items show the current date and time on the computer. If you are running a Windows OS, these items are automatically updated whenever you make changes to the Windows Date and Time Properties utility.

▶ IDE Devices (None)

Your computer has two IDE channels (Primary and Secondary) and each channel can be installed with one or two devices (Master and Slave). Use these items to configure each device on the IDE channel.

Press <Enter> to display the IDE submenu:

Phoenix – AwardBIOS CMOS Setup Utility IDE Primary Master

IDE HDD Auto-Detection	[Press Enter]	Item Help
IDE Primary Master	[Auto]	
Access Mode	[Auto]	Menu Level ▶▶
Capacity	0 MB	To auto-detect the HDD's size, head . . . on this channel
Cylinder	0	
Head	0	
Precomp	0	
Landing Zone	0	
Sector	0	

↑↓ → ← : Move Enter : Select +-/PU/PD:Value: F10: Save ESC: Exit F1:General Help
F5:Previous Values F6:Fail-Safe Defaults F7:Optimized Defaults

IDE HDD Auto-Detection

Press <Enter> while this item is highlighted to prompt the Setup Utility to automatically detect and configure an IDE device on the IDE channel.

Note: If you are setting up a new hard disk drive that supports LBA mode, more than one line will appear in the parameter box. Choose the line that lists LBA for an LBA drive.

IDE Primary/Secondary Master/Slave (Auto)

Leave this item at Auto to enable the system to automatically detect and configure IDE devices on the channel. If it fails to find a device, change the value to Manual and then manually configure the drive by entering the characteristics of the drive in the items described below.

Refer to your drive's documentation or look on the drive casing if you need to obtain this information. If no device is installed, change the value to None.

Note: Before attempting to configure a hard disk drive, ensure that you have the configuration information supplied by the manufacturer of your hard drive. Incorrect settings can result in your system not recognizing the installed hard disk.

Access Mode

This item defines ways that can be used to access IDE hard disks such as LBA (Large Block Addressing). Leave this value at Auto and the system will automatically decide the fastest way to access the hard disk drive.

Press <Esc> to return to the Standard CMOS Features page.

Drive A/Drive B (1.44M, 3.5 in.)

These items define the characteristics of any diskette drive attached to the system. You can connect one or two diskette drives.

Floppy 3 Mode Support (Disabled)

Floppy 3 mode refers to a 3.5-inch diskette with a capacity of 1.2 MB. Floppy 3 mode is sometimes used in Japan.

Video (EGA/VGA)

This item defines the video mode of the system. This motherboard has a built-in VGA graphics system; you must leave this item at the default value.

Halt On (All Errors)

This item defines the operation of the system POST (Power On Self Test) routine. You can use this item to select which types of errors in the POST are sufficient to halt the system.

Base Memory, Extended Memory, and Total Memory

These items are automatically detected by the system at start up time. These are display-only fields. You cannot make changes to these fields.

Advanced BIOS Features

This option defines advanced information about your system.

Phoenix – AwardBIOS CMOS Setup Utility Advanced BIOS Setup

	[Press Enter]	Item Help
▶ CPU Feature	[Disabled]	Menu Level ▶
Virus Warning	[Enabled]	Allows you to choose the VIRUS warning feature for IDE Hard Disk boot sector protection. If this function is enabled and someone attempts to write data into this area, BIOS will show a warning message on screen and alarm beep
CPU L1 & L2 Cache	[Enabled]	
CPU L3 Cache	[Enabled]	
Quick Power On Self Test	[Floppy]	
First Boot Device	[HDD-0]	
Second Boot Device	[CDROM]	
Third Boot Device	[Enabled]	
Boot Other Device	[Disabled]	
Swap Floppy Drive	[Disabled]	
Boot Up Floppy Seek	[On]	
Boot Up NumLock Status	[Fast]	
Gate A20 Option	Enabled	
ATA 66/100 Cable MSG	[Disabled]	
Typematic Rate Setting	6	
x Typematic Rate (Chars/Sec)	250	
x Typematic Delay (Msec)	[Setup]	
Security Option	[Enabled]	
APIC Mode	[Non-OS2]	
OS Select For DRAM > 64MB	[Disabled]	
HDD S.M.A.R.T Capability		

↑↓→← : Move Enter : Select +/-/PU/PD:Value: F10: Save ESC: Exit F1:General Help
F5:Previous Values F6:Fail-Safe Defaults F7:Optimized Defaults

▶ CPU Feature (Press Enter)

Scroll to this item and press <Enter> to view the following screen, and the following items are only available when the motherboard supports Prescott CPU:

Phoenix – AwardBIOS CMOS Setup Utility CPU Feature

	[Thermal Monitor 1]	Item Help
Thermal Management	[0 X]	Menu Level ▶▶
TM2 Bus Ratio	[0.8375V]	Thermal Monitor 1 (On die throttling)
TM2 Bus VID	[Disabled]	Thermal Monitor 2 Ratio & VID transition
Limit CPUID MaxVal		

↑↓→← : Move Enter : Select +/-/PU/PD:Value: F10: Save ESC: Exit F1:General Help
F5:Previous Values F6:Fail-Safe Defaults F7:Optimized Defaults

Thermal Management (Thermal Monitor 1)

This item sets CPU's thermal control rule to protect CPU from overheat. This feature is only available when CPU supports Thermal Monitor 2.

TM2 Bus Ratio (0 X)

This item helps you to set the frequency (bus ratio) of the throttled performance that will be initiated when the on die sensor goes from not hot to hot. You may set the bus ration number from 0 to 255.

TM2 Bus VID (0.8375V)

This item helps you to set the voltage of the throttled performance that will be initiated when the on die sensor goes from not hot to hot.

Limit CPUID MaxVal (Disabled)

This item limits the CPUID maximum value. Enable this item to install WinNT. Leave this item at the default value for other OS.

Press <Esc> to return to the Advanced BIOS Features screen.

Virus Warning (Disabled)

When enabled, this item provides protection against viruses that try to write to the boot sector and partition table of your hard disk drive. You need to disable this item when installing an operating system. We recommend that you enable this item as soon as you have installed an operating system.

Note: For complete protection against viruses, install virus software in your operating system and update the virus definitions regularly.

CPU L1 and L2 Cache (Enabled)

All processors that can be installed in this motherboard use internal level 1 (L1) and external level 2 (L2) cache memory to improve performance. Leave this item at the default value for better performance.

CPU L3 Cache (Enabled)

Some high-end processors support L3. If the CPU do support L3, you may set this item to enable or disable. Leave this item at the default value for better performance.

Quick Power On Self Test (Enabled)

Enable this item to shorten the power on testing (POST) and have your system start up faster. You might like to enable this item after you are confident that your system hardware is operating smoothly.

First/Second/Third Boot Device (Floppy/HDD-0/CDROM)

Use these three items to select the priority and order of the devices that your system searches for an operating system at start-up time.

Boot Other Device (Enabled)

When enabled, the system searches all other possible locations for an operating system if it fails to find one in the devices specified under the First, Second, and Third boot devices.

Swap Floppy Drive (Disabled)

If you have two floppy diskette drives in your system, this item allows you to swap the assigned drive letters so that drive A becomes drive B, and drive B becomes drive A.

Boot Up Floppy Seek (Disabled)

If this item is enabled, it checks the size of the floppy disk drives at start-up time. You don't need to enable this item unless you have a legacy diskette drive with 360K capacity.

Boot Up NumLock Status (On)

This item defines if the keyboard Num Lock key is active when your system is started.

Gate A20 Option (Fast)

This item defines how the system handles legacy software that was written for an earlier generation of processors. Leave this item at the default value.

ATA 66/100 Cable MSG (Enabled)

This item enables or disables the display of the ATA 66/100 Cable MSG.

Typematic Rate Setting (Disabled)

If this item is enabled, you can use the following two items to set the typematic rate and the typematic delay settings for your keyboard.

- **Typematic Rate (Chars/Sec):** Use this item to define how many characters per second are generated by a held-down key.
- **Typematic Delay (Msec):** Use this item to define how many milliseconds must elapse before a held-down key begins generating repeat characters.

Security Option (Setup)

If you have installed password protection, this item defines if the password is required at system start up, or if it is only required when a user tries to enter the Setup Utility.

APIC Mode (Enable)

This option is use to enabled or disabled APIC (Advanced Programmable Interrupt Controller) functionality. The APIC is an Intel chip that provides symmetric multiprocessing (SMP) for its Pentium systems.

OS Select For DRAM > 64 MB (Non-OS2)

This item is only required if you have installed more than 64 MB of memory and you are running the OS/2 operating system. Otherwise, leave this item at the default.

HDD S.M.A.R.T Capability (Disabled)

The S.M.A.R.T. (Self-Monitoring, Analysis, and Reporting Technology) system is a diagnostics technology that monitors and predicts device performance. S.M.A.R.T. software resides on both the disk drive and the host computer.

The disk drive software monitors the internal performance of the motors, me-

dia, heads, and electronics of the drive. The host software monitors the overall reliability status of the drive. If a device failure is predicted, the host software, through the Client WORKS S.M.A.R.T applet, warns the user of the impending condition and advises appropriate action to protect the data.

Report No FDD For WIN95 (Yes)

If you are running a system with no floppy drive and using Windows 95, select Yes for this item to ensure compatibility with the Windows 95 logo certification. Otherwise, select No.

Small Logo (EPA) Show (Disabled)

Enables or disables the display of the EPA logo during boot.

Advanced Chipset Features

These items define critical timing parameters of the motherboard. You should leave the items on this page at their default values unless you are very familiar with the technical specifications of your system hardware. If you change the values incorrectly, you may introduce fatal errors or recurring instability into your system.

Phoenix – AwardBIOS CMOS Setup Utility
Advanced Chipset Features

▶ Advanced DRAM Control 1	[Press Enter]	Item Help
Prefetch Caching	[Disabled]	
AGP Aperture Size	[128MB]	Menu Level ▶
Graphic Window WR Combin	[Enabled]	

↑↓→← : Move Enter : Select +/-/PU/PD:Value: F10: Save ESC: Exit F1:General Help
 F5:Previous Values F6:Fail-Safe Defaults F7:Optimized Defaults

► Advanced DRAM Control 1

Scroll to this item and press <Enter> to view the following screen:

CMOS Setup Utility – Copyright (C) 1984 – 2001 Award Software
Advanced DRAM Control 1

System Performance	[Normal Mode]	Item Help
CAS Latency Setting	[2.5T]	
DRAM Addr/Cmd Rate	[Auto Mode]	Menu Level ►

↑↓→← : Move Enter : Select +/-/PU/PD:Value: F10: Save ESC: Exit F1:General Help
F5:Previous Values F6:Fail-Safe Defaults F7:Optimized Defaults

System Performance (Normal Mode)

This is the DRAM auto configuration option, which can be set to Safe Mode, Normal Mode, Fast Mode or Ultra Mode.

CAS Latency Setting (2.5T)

Enables you to select the CAS latency time in HCLKs of 2, 2.5, or 3. The value is set at the factory depending on the DRAM installed. Do not change the values in this field unless you change specifications of the installed DRAM or the installed CPU.

DRAM Addr/Cmd Rate (Auto Mode)

This option allows you to set the lead off DRAM read and write cycles. When set to Delay 1T, memory read/write commands are sent one clock cycle behind the memory address. When set to Normal, read/write and memory address commands are sent simultaneously.

Press <Esc> to return to the Advanced Chipset Features screen.

Prefetch Caching (Disabled)

Enables PCI slave prefetch caching. Enabling this increased performance.

AGP Aperture Size (128MB)

This item defines the size of the aperture if you use an AGP graphics adapter. It refers to a section of the PCI memory address range used for graphics memory. We recommend that you leave this item at the default value.

Graphic Window WR Combin (Enabled)

This item determines whether the graphic windows base address is valid or not.

Integrated Peripherals

These options display items that define the operation of peripheral components on the system's input/output ports.

Phoenix – AwardBIOS CMOS Setup Utility Integrated Peripherals

		Item Help
▶ SIS OnChip IDE Device	[Press Enter]	
▶ SIS OnChip PCI Device	[Press Enter]	
▶ Onboard SuperIO Device	[Press Enter]	Menu Level ▶
USB Controller	[Enabled]	
USB Ports Number	[6 Ports]	
USB 2.0 Supports	[Enabled]	
USB Keyboard Support	[Disabled]	
IDE HDD Block Mode	[Enabled]	
Init Display First	[PCI Slot]	
AGP Auto Calibration	[Enabled]	
IDECHO Access Interface	[EDB Bus]	
IDECH1 Access Interface	[EDB Bus]	
USB0 Access Interface	[EDB Bus]	
USB1 Access Interface	[EDB Bus]	
USB2 Access Interface	[EDB Bus]	
USB2.0 Access Interface	[EDB Bus]	
Audio Access Interface	[EDB Bus]	

↑↓→← : Move Enter : Select +/-/PU/PD:Value: F10: Save ESC: Exit F1:General Help
 F5:Previous Values F6:Fail-Safe Defaults F7:Optimized Defaults

▶ SIS OnChip IDE Device

Scroll to this item and press <Enter> to view the following screen:

Phoenix – AwardBIOS CMOS Setup Utility SIS OnChip IDE Device

		Item Help
Internal PCI/IDE	[Both]	
IDE Primary Master PIO	[Auto]	
IDE Primary Slave PIO	[Auto]	Menu Level ▶▶
IDE Secondary Master PIO	[Auto]	
IDE Secondary Slave PIO	[Auto]	
Primary Master UltraDMA	[Auto]	
Primary Slave UltraDMA	[Auto]	
Secondary Master UltraDMA	[Auto]	
Secondary Slave UltraDMA	[Auto]	
IDE DMA Transfer Access	[Enabled]	
IDE Burst Mode	[Enabled]	

↑↓→← : Move Enter : Select +/-/PU/PD:Value: F10: Save ESC: Exit F1:General Help
 F5:Previous Values F6:Fail-Safe Defaults F7:Optimized Defaults

Internal PCI/IDE (Both)

Use these items to enable or disable the internal PCI IDE channels that are integrated on the motherboard.

ECP Mode Use DMA (3)

When the onboard parallel port is set to ECP mode, the parallel port can use DMA 3 or DMA 1.

Press <Esc> to return to the Integrated Peripherals screen.

USB Controller (Enabled)

Enable this item if you plan to use the Universal Serial Bus ports on this motherboard.

USB Keyboard Support (Disabled)

Enable this item if you plan to use a keyboard connected through the USB port in a legacy operating system (such as DOS) that does not support Plug and Play.

IDE HDD Block Mode (Enabled)

Enable this field if your IDE hard drive supports block mode. Block mode enables BIOS to automatically detect the optimal number of block read and writes per sector that the drive can support. It also improves the speed of access to IDE devices.

Init Display First (PCI Slot)

Use this item to specify whether your graphics adapter is installed in one of the PCI slots or is integrated on the motherboard.

AGP Auto Calibration (Enabled)

This item allows you to enable or disable the AGP buffer strength auto calibration through the chipset.

IDECH0/IDECH1 ACCESS INTERFACE (EDB Bus)

This item determines whether the IDE access interface is the PCI bus or the embedded bus.

USB0/USB1/USB2 ACCESS INTERFACE (EDB Bus)

This option determines whether the USB0/USB1/USB2 access interface is the embedded bus or the PCI bus.

USB2.0 ACCESS INTERFACE (EDB BUS)

This option determines whether the USB2.0 access interface is the embedded bus or a PCI bus.

Audio ACCESS INTERFACE (EDB BUS)

This option determines whether the audio access interface is the embedded bus or a PCI bus.

Power Management Setup

This option lets you control system power management. The system has various power-saving modes including powering down the hard disk, turning off the video, suspending to RAM, and software power down that allows the system to be automatically resumed by certain events.

Power Management Timeouts

The power-saving modes can be controlled by timeouts. If the system is inactive for a time, the timeouts begin counting. If the inactivity continues so that the timeout period elapses, the system enters a power-saving mode. If any item in the list of Reload Global Timer Events is Enabled, then any activity on that item will reset the timeout counters to zero.

Wake Up Calls

If the system is suspended, or has been powered down by software, it can be resumed by a wake up call that is generated by incoming traffic to a modem, a LAN card, a PCI card, or a fixed alarm on the system realtime clock,

Phoenix – AwardBIOS CMOS Setup Utility Power Management Setup

		Item Help
ACPI function	[Enabled]	
ACPI Suspend Type	[S1(POS)]	
Video Off Option	[Susp, Stby --> Off]	Menu Level ▶
Video Off Method	[DPMS Supported]	
MODEM Use IRQ	[Auto]	
Hot Key Function as	[Power Off]	
HDD Off After	[Disabled]	
Power Button Override	[Instant-Off]	
Power State Resume Control	[Always Off]	
▶ PM Wake Up Events	[Press Enter]	
Delay Prior to Thermal	[None]	

↑↓ → ← : Move Enter : Select +/-/PU/PD: Value: F10: Save ESC: Exit F1: General
 Help F5: Previous Values F6: Fail-Safe Defaults F7: Optimized Defaults

ACPI Function (Enabled)

This motherboard supports ACPI (Advanced Configuration and Power management Interface). Use this item to enable or disable the ACPI feature.

Note: ACPI is a power management specification that makes hardware status information available to the operating system. ACPI enables a PC to turn its peripherals on and off for improved power management. It also allows the PC to be turned on and off by external devices, so that mouse or keyboard activity wakes up the computer.

ACPI Suspend Type (S1(POS))

Use this item to define how your system suspends. In the default, S1(POS),

the suspend mode is a suspend to a software power down. If you select S3(STR), the suspend mode is a suspend to RAM, i.e., the system shuts down with the exception of a refresh current to the system memory.

Video Off Option (Susp, Stby --> Off)

This option defines if the video is powered down when the system is put into suspend mode.

Video Off Method (DPMS Supported)

This item defines how the video is powered down to save power. This item is set to DPMS (Display Power Management Software) by default.

MODEM Use IRQ (Auto)

If you want an incoming call on a modem to automatically resume the system from a power-saving mode, use this item to specify the interrupt request line (IRQ) that is used by the modem. You might have to connect the fax/modem to the motherboard Wake On Modem connector for this feature to work.

Hot Key Function As (Power Off)

This option allows you to set the Hot Key functionality to one of the following states: Disable (turn off Hot Key functionality), Power Off, Suspend.

HDD Off After (Disable)

The IDE hard drive will spin down if it is not accessed within a specified length of time. Options are from 1 Min to 15 Min and Disable.

Power Button Override (Instant Off)

Under ACPI (Advanced Configuration and Power management Interface) you can create a software power down. In a software power down, the system can be resume by Wake Up Alarms. This item lets you install a software power down that is controlled by the power button on your system. If the item is set to Instant-Off, then the power button causes a software power down. If the item is set to Delay 4 Sec. then you have to hold the power button down for four seconds to cause a software power down.

Power State Resume Control (Always Off)

This sets the power state after a shutdown due to an unexpected interrupt of AC power.

Delay Prior to Thermal (None)

This sets the delay time before the CPU enters auto thermal mode.

that occurs to a device that is configured as Enabled, even when the system is in a power-down mode.

Primary/Secondary IDE 1/0 (Disabled)

When these items are enabled, the system will restart the power-saving timeout counters when any activity is detected on any of the drives or devices on the primary or secondary IDE channels.

FDD, COM, LPT Port (Disabled)

When this item is enabled, the system will restart the power-saving timeout counters when any activity is detected on the floppy disk drive, serial ports, or the parallel port.

PCI PIRQ[A-D]# (Disabled)

When disabled, any PCI device set as the Master will not power on the system.

PWRON After PWR-Fail (Off)

This item enables your computer to automatically restart or return to its last operating status after power returns from a power failure.

Press <Esc> to return to the Power Management screen.

PC Health Status

On motherboards that support hardware monitoring, this item lets you monitor the parameters for critical voltages, critical temperatures, and fan speeds.

Phoenix – AwardBIOS CMOS Setup Utility PC Health Status

Shutdown Temperature CPU Core Voltage CPU Temperature CPUFAN Speed	[Disabled]	Item Help
		Menu Level ►

↑↓→← : Move Enter : Select +/-/PU/PD:Value: F10: Save ESC: Exit F1:General Help
F5:Previous Values F6:Fail-Safe Defaults F7:Optimized Defaults

Shutdown Temperature

Enables you to set the maximum temperature the system can reach before powering down.

System Component Characteristics

These fields provide you with information about the systems current operating status. You cannot make changes to these fields.

Frequency/Voltage Control

This item enables you to set the clock speed and system bus for your system. The clock speed and system bus are determined by the kind of processor you have installed in your system.

Phoenix – AwardBIOS CMOS Setup Utility Frequency/Voltage Control

CPU Clock Ratio Auto Detect DIMM/PCI Clk Spread Spectrum CPU Host/SDRAM/PCI Clock	[0 X] [Enabled] [Enabled] [Default]	Item Help
		Menu Level ►

↑↓→← : Move Enter : Select +/-/PU/PD:Value: F10: Save ESC: Exit F1:General Help
F5:Previous Values F6:Fail-Safe Defaults F7:Optimized Defaults

CPU Clock Ratio (0 X)

Use the CPU Host/SDRAM/PCI Clock to set the frontside bus frequency for the installed processor (usually 133 MHz, 100 MHz or 66 MHz). Then use *CPU Clock Ratio Jumpless* to set a multiple. The multiple times the frontside bus must equal the core speed of the installed processor e.g., **3.5 (multiple) x 100 MHz (frontside bus) = 350 MHz (installed processor clock speed)**.

Auto Detect DIMM/PCI Clk (Enabled)

When this item is enabled, BIOS will disable the clock signal of free DIMM and PCI slots.

Spread Spectrum (Enabled)

If you enable spread spectrum, it can significantly reduce the EMI (Electro-Magnetic Interference) generated by the system.

CPU Host/SDRAM/PCI Clock (Default)

Use the CPU Host Clock to set the frontside bus frequency for the installed processor (usually 133 MHz, 100 MHz or 66 MHz).

Load Fail-Safe Defaults Option

This option opens a dialog box that lets you install fail-safe defaults for all appropriate items in the Setup Utility:

Press <Y> and then <Enter> to install the defaults. Press <N> and then <Enter> to not install the defaults. The fail-safe defaults place no great demands on the system and are generally stable. If your system is not functioning correctly, try installing the fail-safe defaults as a first step in getting your system working properly again. If you only want to install fail-safe defaults for a specific option, select and display that option, and then press <F6>.

Load Optimized Defaults Option

This option opens a dialog box that lets you install optimized defaults for all appropriate items in the Setup Utility. Press <Y> and then <Enter> to install the defaults. Press <N> and then <Enter> to not install the defaults. The optimized defaults place demands on the system that may be greater than the performance level of the components, such as the CPU and the memory. You can cause fatal errors or instability if you install the optimized defaults when your hardware does not support them. If you only want to install setup defaults for a specific option, select and display that option, and then press <F7>.

Set Supervisor/User Password

When this function is selected, the following message appears at the center of the screen to assist you in creating a password.

ENTER PASSWORD

Type the password, up to eight characters, and press <Enter>. The password typed now will clear any previously entered password from CMOS memory. You will be asked to confirm the password. Type the password again and press <Enter>. You may also press <Esc> to abort the selection.

To disable password, just press <Enter> when you are prompted to enter password. A message will confirm the password being disabled. Once the password is disabled, the system will boot and you can enter BIOS Setup freely.

PASSWORD DISABLED

If you have selected **"System"** in "Security Option" of "BIOS Features Setup" menu, you will be prompted for the password every time the system reboots or any time you try to enter BIOS Setup.

If you have selected **"Setup"** at "Security Option" from "BIOS Features Setup" menu, you will be prompted for the password only when you enter BIOS Setup.

Supervisor Password has higher priority than User Password. You can use Supervisor Password when booting the system or entering BIOS Setup to modify all settings. Also you can use User Password when booting the system or entering BIOS Setup but can not modify any setting if Supervisor Password is enabled.

Save & Exit Setup Option

Highlight this item and press <Enter> to save the changes that you have made in the Setup Utility and exit the Setup Utility. When the Save and Exit dialog box appears, press <Y> to save and exit, or press <N> to return to the main menu:

Exit Without Saving

Highlight this item and press <Enter> to discard any changes that you have made in the Setup Utility and exit the Setup Utility. When the Exit Without Saving dialog box appears, press <Y> to discard changes and exit, or press <N> to return to the main menu.

Note: If you have made settings that you do not want to save, use the "Exit Without Saving" item and press <Y> to discard any changes you have made.

This concludes Chapter 3. Refer to the next chapter for information on the software supplied with the motherboard.

Using the Motherboard Software

About the Software CD-ROM

The support software CD-ROM that is included in the motherboard package contains all the drivers and utility programs needed to properly run the bundled products. Below you can find a brief description of each software program, and the location for your motherboard version. More information on some programs is available in a README file, located in the same directory as the software.

Note: Never try to install software from a folder that is not specified for use with your motherboard.

Before installing any software, always inspect the folder for files named README.TXT, INSTALL.TXT, or something similar. These files may contain important information that is not included in this manual.

Auto-installing under Windows 98/ME/2000/XP

The Auto-install CD-ROM makes it easy for you to install the drivers and software for your motherboard.

Note: If the Auto-install CD-ROM does not work on your system, you can still install drivers through the file manager for your OS (for example, Windows Explorer). Refer to Utility Folder Installation Notes later in this chapter.

The support software CD-ROM disc loads automatically under Windows 98/ME/2000/XP. When you insert the CD-ROM disc in the CD-ROM drive, the autorun feature will automatically bring up the install screen. The screen has three buttons on it, Setup, Browse CD and Exit.

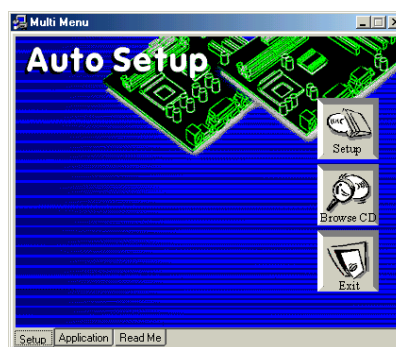

Note: If the opening screen doesn't appear, double-click the file "setup.exe" in the root directory.

Setup Tab

Setup	Click the Setup button to run the software installation program. Select from the menu which software you want to install.
Browse CD	<p>The Browse CD button is the standard Windows command that allows you to open Windows Explorer and show the contents of the support CD.</p> <p>Before installing the software from Windows Explorer, look for a file named README.TXT, INSTALL.TXT or something similar. This file may contain important information to help you install the software correctly.</p> <p>Some software is installed in separate folders for different operating systems, such as DOS, WIN NT, or WIN98/95. Always go to the correct folder for the kind of OS you are using.</p> <p>To install the software, execute a file named SETUP.EXE or INSTALL.EXE by double-clicking the file and then following the instructions on the screen.</p>
Exit	The Exit button closes the Auto Setup window.

Application Tab

Lists the software utilities that are available on the CD.

Read Me Tab

Displays the path for all software and drivers available on the CD.

Running Setup

Follow these instructions to install device drivers and software for the motherboard:

9. Click **Setup**. The installation program begins:



Note: The following screens are examples only. The screens and driver lists will be different according to the motherboard you are installing.

The motherboard identification is located in the upper left-hand corner.

10. Click **Next**. The following screen appears:

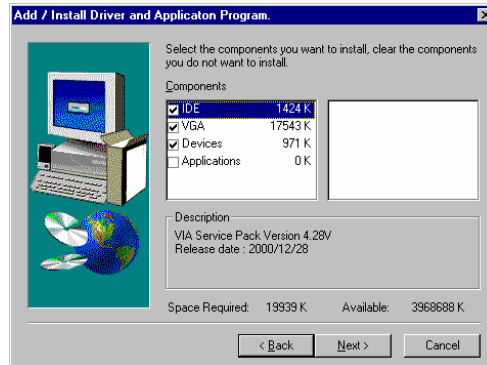

11. Check the box next to the items you want to install. The default options are recommended.
12. Click **Next** run the Installation Wizard. An item installation screen appears:



13. Follow the instructions on the screen to install the items.

Drivers and software are automatically installed in sequence. Follow the on-screen instructions, confirm commands and allow the computer to restart a few times to complete the installation.

Manual Installation

Insert the CD in the CD-ROM drive and locate the PATH.DOC file in the root directory. This file contains the information needed to locate the drivers for your motherboard.

Look for the chipset and motherboard model; then browse to the directory and path to begin installing the drivers. Most drivers have a setup program (SETUP.EXE) that automatically detects your operating system before installation. Other drivers have the setup program located in the operating system subfolder.

If the driver you want to install does not have a setup program, browse to the operating system subfolder and locate the readme text file (README.TXT or README.DOC) for information on installing the driver or software for your operating system.

Utility Software Reference

All the utility software available from this page is Windows compliant. They are provided only for the convenience of the customer. The following software is furnished under license and may only be used or copied in accordance with the terms of the license.

Note: These software(s) are subject to change at anytime without prior notice.
Please refer to the support CD for available software.

AWARD Flash Memory Utility

This utility lets you erase the system BIOS stored on a Flash Memory chip on the motherboard, and lets you copy an updated version of the BIOS to the chip. Proceed with caution when using this program. If you erase the current BIOS and fail to write a new BIOS, or write a new BIOS that is incorrect, your system will malfunction. Refer to Chapter 3, *Using BIOS* for more information.

WinFlash Utility

The Award WinFlash utility is a Windows version of the DOS Award BIOS flash writer utility. The utility enables you to flash the system BIOS stored on a Flash Memory chip on the motherboard while in a Windows environment. This utility is currently available for WINXP\ME\2000\98SE. To install the WinFlash utility, run WINFLASH.EXE from the following directory:

UTILITY\WINFLASH 1.51

PC-CILLIN 2002

The PC-CILLIN 2002 software program provides anti-virus protection for your system. This program is available for Windows 2000/ME/98SE/XP and Windows NT. Be sure to check the readme.txt and install the appropriate anti-virus software for your operating system.

We strongly recommend users to install this free anti-virus software to help protect your system against viruses.

This concludes Chapter 4.