



F-06D

INSTRUCTION MANUAL '11.11

docomo STYLE series

Thank you for purchasing "F-06D".

Before using F-06D, read this manual to ensure safe use and handling.

About manuals for F-06D

The operations of F-06D are described in this manual, "使いかたガイド (Guide)" (installed in FOMA terminal) and "Instruction manual (detailed version)" (in pdf format).

Instruction manual (this manual)

This manual provides information about screens and operations of basic functions.

"使いかたガイド (Guide)" (installed in FOMA terminal)

This guide provides overviews and operations of frequently-used functions. (In Japanese only)
In F-06D Stand-by display, **MENU** ▶ **6** Tool ▶ **#** Guide ▶ Select a search method

"Instruction manual (detailed version)" (in pdf format)

This manual provides detailed information and operations of all the functions. (In Japanese only)
<From a PC> This manual can be downloaded from NTT DOCOMO website.
<http://www.nttdocomo.co.jp/support/trouble/manual/download/index.html>
* The URL and contents are subject to change without prior notice.

- In this "F-06D INSTRUCTION MANUAL", "F-06D" mobile terminal is usually referred to as "FOMA terminal".
- The images or illustration used in this manual are examples. They may differ from the actual displays.
- The images used in this manual assume that Kisekai Tool is set to "White" and Color theme setting is set to "White".
- In this manual, "authenticate" indicates the operating procedure for entering the terminal security code in 4-8 digits.

Basic package

F-06D

(including Back Cover F69 and warranty)



Battery Pack F19



Desktop Holder F33



Instruction manual



Touch pen F01



Compatible options⇒P81

- Unauthorized copying of parts of or this entire manual is prohibited.
- The contents in this manual, URL and contents are subject to change without prior notice.

Contents

FOMA terminal	2	Precautions (Always follow these directions)	7	Introduction
What you can do with F-06D	3	Handling precautions	16	
Part names and functions	4	Waterproofness	19	
Open assist button	6			
Before Using	23	Sound/Screen Setting	32	Basic Operation
Screen Explanation	26	Lock/Security	36	
Character Entry	30			
Call Telephone	40			Connect
Mail	48			
Phonebook	51			
i-mode/Full Browser/Smart Browser	52	Map/GPS	55	Search
i-Channel	54			
Camera	57	i-appli	64	Enjoy
1Seg	60	i-motion/Movie	65	
Music	62			
Osaifu-Keitai	66	Data Management	71	More Convenient
i-concier	67			
Convenient tools	68			
Support	75			Others
Appendix	82			
Index	98			

FOMA terminal

- F-06D supports W-CDMA, GSM/GPRS System.
- Because your FOMA terminal uses wireless transmission, it may not function in locations where it is difficult for radio waves to penetrate, such as tunnels, underground passages and some buildings, in areas where radio waves are weak, or out of service area. Even when you are high up in a tall building or condominium and nothing blocks your view outside, your FOMA terminal may not be able to receive or transmit signals. Also, communication may be interrupted even when the signal meter on your FOMA terminal indicates there are strong radio waves and you are not moving (traveling).
- Because your FOMA terminal uses radio waves to communicate, it is possible that a third party may attempt to tap your calls. However, the W-CDMA, GSM/GPRS automatically applies a confidential communication function to all calls, so even if a third party could somehow tap a call, they only hear noise.
- Your FOMA terminal encodes voice communication as digital data. When you are operating your FOMA terminal while moving to a location subject to weaker radio wave conditions, the transmitted digital data may not be correctly decoded and as a result the decoded voice may differ somewhat from the actual voice.
- Maintain a separate record of the data (Phonebook, Schedule, Memo, Recorded messages, Voice memos, Moving picture memos, etc.) you registered in your FOMA terminal. Note that DOCOMO assumes no responsibility for any loss of saved contents of data resulting from malfunction, repair, changing of the model or other handling of FOMA terminal.
- You are recommended to save important data to microSD card. Using DOCOMO keitai datalink, you can transfer and save phonebook, mail, schedule and other data to a PC.
- The user hereby agrees that the user shall be solely responsible for the result of the use of SSL/TLS. Neither DOCOMO nor the certifier as listed herein makes any representation and warranty as for the security in the use of SSL/TLS. If the data should be erased, DOCOMO assumes no responsibility for the loss of any data.
Certifier : VeriSign Japan K.K., Cybertrust Japan Co., Ltd., GlobalSign K.K., RSA Security Japan Ltd., SECOM Trust Systems Co., Ltd., Comodo CA Ltd., Entrust, Inc., Go Daddy, Inc.
- This FOMA terminal supports FOMA Plus-Area and FOMA HIGH-SPEED Area.

■ SIM unlock

This FOMA terminal supports SIM unlock. If you release SIM lock, you can use SIM by a carrier other than NTT DOCOMO.

- The SIM unlock service is provided at a docomo Shop.
- A SIM unlock charge is separately required.
- If you use a SIM other than by DOCOMO, available services and functions will be limited. DOCOMO is not liable to any failures or malfunctions.
- For details of SIM unlock, refer to NTT DOCOMO website.

What you can do with F-06D

Waterproofness

19

Waterproofness of IPX5 and IPX8 is provided by firmly closing the external connection jack cap and installing the back cover in a locked state.

docomo Palette UI

29

● MyFACE

In the right and left area of the stand-by display, MyFACE contents showing various information can be freely pasted. MyFACE information is updated regularly to provide you new information. You can download desired contents from websites to add to MyFACE, sort and delete contents easily.

● Shortcuts

Shortcuts can be freely pasted at the bottom of the screen. Paste shortcuts for frequently used functions or desired contents to access easily. You can easily group or sort shortcuts.

使いかたガイド (Guide)

29

Without the instruction manual at your hand, you can check readily the operations of function. (In Japanese only)

eco mode

35

The eco mode allows you to save the battery power by adjusting the display backlight, etc. And you can set to automatically switch eco mode to ON according to the battery level.

Koe-no-Takuhaibin

41

Koe-no-Takuhaibin takes voice messages using voice call and notifies existence of message to the party by SMS. And notify you by SMS when the party plays a message.

AUTO-GPS

56

The AUTO-GPS function provides you useful services that deliver information about the weather or shops around where you are, or sightseeing information. (In Japanese only) You can also enjoy a game using your location or the distance you moved.

Graffiti picture

59

Decorate a still image drawing lines or pasting stamps with the included touch pen. Shooting from the dedicated screen which provides you easy instructions is also available.

i-concier

67

It is a service that Machi-chara (a character on the stand-by display) supports your life like a butler or concierge. It stores your various information (area of residence, memo, schedule, ToruCa, phonebook, etc.) and offers you information that matches contents of Memo or Schedule, your living area or current location, or preferences and interest at the right time. (In Japanese only)

Shabette-Kensaku

68

You can use i-mode search by your voice. While displaying "Speak keyword in Japanese", speak a keyword (a word which interests you, station name, address, etc.) to search via i-mode.

Personal alarm

70

In Kid-safe mode, a loud alarm for emergency is available. With a loud alarm, making a voice call automatically or notifying your location using GPS function can be set.

Part names and functions



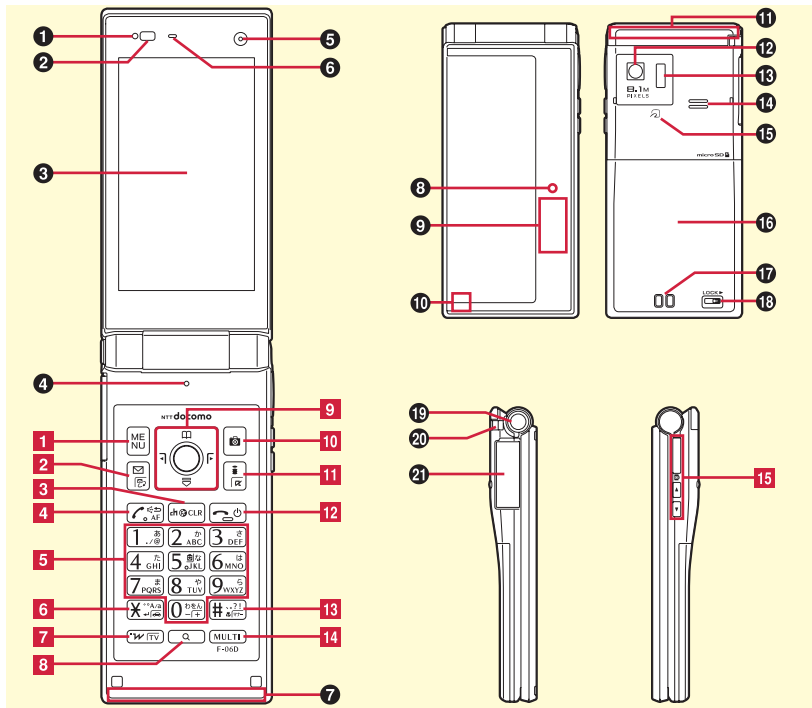

















Part names of F-06D and major functions assigned to each part are as follows.







To use the function with *, press the key for 1 second or more.

- 1 Light sensor for sensing the ambient lightness to adjust the brightness of the display
- 2 Videophone call, camera light for still image/movie shooting
- 3 Display (Touch panel)
Used as touch panel only for Graffiti picture.
- 4 Microphone
- 5 IN camera
- 6 Earpiece
- 7 1Seg antenna is built-in
Covering around the antenna by the hand may affect the quality.
- 8 Light that turns on when receiving a call, using a camera, while charging, etc.
- 9 Sub-display
- 10 GPS antenna is built-in
Covering around the antenna by the hand may affect the quality.
- 11 FOMA antenna is built-in
Covering around the antenna by the hand may affect the quality.
- 12 OUT camera
- 13 Infrared data port for infrared communication or infrared remote control function
- 14 Speaker
- 15  mark for placing over IC card reader for Osaifu-Keitai and iC transmission
- 16 Back cover
To access docomo mini UIM card slot and the microSD card slot, remove the back cover and the battery pack.
- 17 Charging jack
- 18 Back cover lever

- 19 Open assist button
- 20 Strap opening
- 21 External connection jack for charger, earphone, etc.

- 1  Display the menu
- 2  Display the mail menu, switch text input modes or check new mail/message*
- 3  Display i-Channel or return to the previous screen
- 4  Start voice call, switch to hands-free call or perform quick voice activation*
- 5  -  Enter phone number or characters, or select menu item, perform function assigned to shortcut (eco mode ON/OFF is assigned to  by default)*
- 6  Enter "*" or voiced/semi-voiced sound, or start/cancel Public mode (Drive mode)*
- 7  Start/Exit i-Widget, or start 1Seg*
- 8  (Search key) Activate Quick search/Shabette-Kensaku*
- 9  (Multi-cursor key) Move the cursor
 -  Perform an operation
 -  Display phonebook, adjust sound volume
 -  Display shortcuts list or adjust sound volume.
 -  Display MyFACE, switch screen or display Received calls when MyFACE usage setting is "OFF"
 -  Display MyFACE, switch screen or display Redial number when MyFACE usage setting is "OFF"
- 10  Start the still camera shooting
- 11  Display iMenu or i-appli folder*
- 12  Exit a running function, or turn ON/OFF the FOMA terminal by pressing for 2 seconds or more
- 13  Enter "#" or punctuation, or start/cancel Silent mode*
- 14  (Multitask key) Start another function during a call or operation, or activate/cancel Privacy view

- 15 (Side key) Light sub-display, switch display**
 (Side camera key) Activate movie shooting, record video during 1Seg watching*, activate/deactivate personal alarm when alarm setting for Kid-safe mode is ON*.
 Adjusting volume
 stops ring alert, alarm, vibrator or activates quick message*,  conducts mail/message inquiry*, etc.

Connection of Stereo Earphone Set 01 (Optional) for external connection jack

* AC adapter uses a common jack.

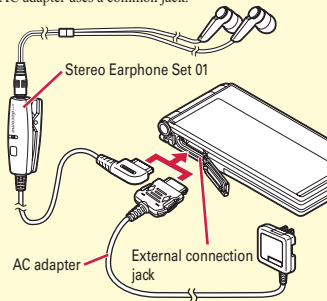

Open assist button

The FOMA terminal can be opened easily only by pushing the dedicated button.

- Even without using the button, the FOMA terminal can be opened easily with light force.

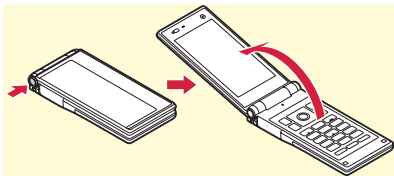



Point



- Make sure to hold the FOMA terminal when operating the open assist button. And when opening, be careful not to hit the FOMA terminal to your face, someone or something, or not to drop the terminal with its rebound.
- Depending on the orientation, the FOMA terminal may not opened completely even by pressing the button.
- Close the FOMA terminal by hand. If the FOMA terminal is not closed completely, once open it completely and then close it.





Precautions (Always follow these directions)

- Before using your FOMA terminal, or when necessary, read the precautions below to ensure safe use and handling. After reading this manual, keep it carefully.
- These precautions are intended to protect you and others around you. Read and follow them carefully to avoid injury, damage to the product or damage to property.
- The signs below differentiate between the levels of danger that can occur if the product is not used within the specified guidelines.

 DANGER	This sign denotes that death or serious injury may directly result from improper use.
 WARNING	This sign denotes that death or serious injury may result from improper use.
 CAUTION	This sign denotes that minor injury or damage to property may result from improper use.

- The symbols below show specific directions.

 Don't	This symbol denotes that the action is prohibited.
 No disassembly	This symbol denotes that disassembling the phone or its components is not allowed.

 No wet hands	This symbol denotes that using the phone or its components with wet hands is not allowed.
 No liquids	This symbol denotes that using the phone or its components in a bathroom or other highly humid area is not allowed.
 Do	This symbol denotes that an instruction must be obeyed at all times.
 Unplug	This symbol denotes that the equipment should be unplugged.

■ Precautions contain the description below.

Handling FOMA terminal, battery pack, adapter, desktop holder, docomo mini UIM card and touch pen (common)	8
Handling FOMA terminal	9
Handling battery pack	11
Handling adapter and desktop holder	12
Handling docomo mini UIM card	13
Handling touch pen	14
Handling mobile phones near electronic medical equipment	14
Material list	15

Handling FOMA terminal, battery pack, adapter, desktop holder, docomo mini UIM card and touch pen (common)

DANGER



Don't

Do not use, store, or leave the equipment in hot areas such as near flames or in areas under strong direct sunlight such as inside a vehicle.

May cause fire, burns or injuries.



Don't

Do not put the terminal into heating cooking device such as microwave oven or high-pressure container.

May cause fire, burns, injuries, electric shock.



No disassembly

Do not disassemble or remodel the equipment.

May cause fire, burns, injuries, electric shock.



No liquids

Do not let the terminal get wet with water, drinking water, urine of pet animals, etc.

May cause fire, burns, injuries, electric shock.

For waterproofness, refer to the page.⇒P19



Do

Use the battery pack and adapter specified by NTT DOCOMO for your FOMA terminal.

May cause fire, burns, injuries, electric shock.

WARNING



Don't

Do not throw the equipment or give strong force or hard shock to it.

May cause fire, burns, injuries, electric shock.



Don't

Keep conductive materials (metal pieces, pencil lead, etc.) from coming in contact with the charging jack or external connection jack. Do not put those materials inside the terminal.

May cause fire, burns, injuries, electric shock.



Don't

Do not cover or wrap the terminal with a blanket, etc while using or charging.

May cause fire or burns.



Do

Turn FOMA terminal OFF and stop charging before entering a place such as a gas station where flammable gases are generated.

The gas may catch fire.

When using Osaifu-Keitai in a place as a gas station, turn OFF the terminal before using it. (When IC card lock is activated, deactivate it before turning OFF the terminal.)



Do

If the equipment starts giving off a strange smell, overheats, becomes discolored or deformed during use, charging or in storage, immediately perform the following operations.

- Remove the power plug from the wall outlet or cigarette lighter socket.
- Turn FOMA terminal OFF.
- Remove the battery pack from FOMA terminal.

May cause fire, burns, injuries, electric shock.

CAUTION



Don't

Do not leave the equipment on unstable or sloping surfaces.

May cause injuries.



Don't

Do not store the equipment in extremely humid, dusty or hot areas.

May cause fire, burns, electric shock.



Do

Children using the equipment should be instructed in proper operation by an adult. Do not allow them to use the equipment without adult supervision.
May cause injuries.



Do

Store the equipment out of reach of small children.
May be accidentally swallowed or cause injuries.



Do

Be careful especially when using FOMA terminal connected to the adapter continuously for a long time.

If you use i-appli, a videophone call or 1Seg watching while charging the battery for a long time, FOMA terminal, battery pack and adapter may be heated.

Directly touching a hot part for a long time, you may have redness, itching or rash on your skin, or it may result in low-temperature burns depending on your constitution and/or health condition.

Handling FOMA terminal



WARNING



Don't

Do not direct the infrared data port toward your eye and transmit signals.
May cause harmful effect on eyes.



Don't

Do not direct the infrared data port toward home electric appliances etc. equipped with infrared device when using infrared communication.
May cause an accident because of malfunction of infrared device.



Don't

Do not turn on the light by getting the lighting part closer to other person's eyes. When shooting infants, keep at least 1 m away from the object.
May impair eyesight. And may cause accidents like injury etc., by dazzling or astounding other people.



Don't

Do not put foreign objects such as liquid like water, metal pieces or burnable things into docomo mini UIM card or microSD card slot.
May cause fire, burns, injuries, electric shock.



Don't

Do not turn on the light aiming directly at the driver of the car etc.
May disturb driving and cause an accident.



Do

Turn FOMA terminal OFF in areas where use is prohibited, such as in airplanes and hospitals.

May cause electronic equipment or electronic medical equipment to fail or malfunction. If the function which automatically turns the power ON is set, cancel the setting before turning the power OFF.

When using the phone in a medical facility, be sure to observe the regulations of the facility. If you do prohibited act such as using the phone in an airplane, you will be punished according to law.

If usage of mobile phones in an aircraft is admitted by setting airplane mode, etc., use the terminal under the direction of the airline.



Do

When you talk by setting handsfree or ring alert is sounding, keep FOMA terminal away from your ear. And, when connecting the earphone/microphone etc. to the FOMA terminal and play a game, music, etc. adjust the volume moderately.

Too loud volume may cause a hearing loss. And, if you cannot hear the sound around you clearly, it may cause an accident.



Do

If you have weak heart, be careful when setting the Vibrate alert (vibration) or alert volume setting.

May cause harmful effect on heart.



Do

When you use electronic medical equipment, check with the equipment manufacturer to determine how the device is affected by radio waves before using.

May cause harmful effect on electronic medical equipment etc.



Do

Turn FOMA terminal OFF near high-precision electronic control equipment or electronic equipment using low-power signals.

May cause the equipment to fail or malfunction.

* Examples of electronic equipment to avoid.

Hearing aids, implanted pacemakers or defibrillators, other electronic medical equipment, fire alarms, automatic doors and other automatic control equipment.

Users wearing implanted pacemakers or defibrillators or other electronic medical equipment should check with the manufacturer or sales outlet about the effect of radio frequencies on the equipment.



Do

When the display or camera lens is accidentally broken, be careful of broken glass or exposed internal parts of FOMA terminal.

Surfaces of display and camera lens are made of plastic panels and they are structured for the glass not to scatter, however, if you mistakenly touch broken or exposed parts, you may be injured.



Do

To sound the personal alarm, always keep FOMA terminal away from your ears.

May cause hearing defect.

**CAUTION**

Don't

Do not swing FOMA terminal by its strap etc.

May cause accident such as injury to yourself or others by hitting.



Don't

Do not use damaged FOMA terminal.

May cause fire, burns, injuries, electric shock.



Don't

When using the motion sensor, check the safety around you, hold FOMA terminal firmly, and do not shake it unnecessarily.

May cause accident such as injuries.



Don't

If the display part is accidentally broken and the liquid crystal leaks out, do not make the substance contact with your skin of face or hands.

May cause loss of sight or skin problems. If the liquid crystal gets into your eyes or mouth, rinse it with clean water and see a doctor immediately.

And, if the liquid adheres to skin or clothing, use alcohol etc. to wipe it off, then wash with soap.



Do

To use the terminal in car, check with automobile manufacturer or dealer to determine how the device is affected by radio waves before using.

In rare cases, using the phone in some vehicle models can cause the vehicle's electronic equipment to malfunction. In that case, stop using the terminal immediately.



Do

Mobile phones can give some users skin problems such as itching, allergic reactions or rashes. If you develop skin problems, stop using the phone immediately, and see a doctor. → "Material list (P15)"



Do

When opening or closing FOMA terminal, take care not to have your fingers or strap caught by the terminal.
May cause accident such as injuries.



Do

When watching the display, take a certain distance from the display in a fully bright place.
May reduce visual acuity.

Handling battery pack

Check that the battery type matches the type displayed on the battery pack label.

Display	Battery type
Li-ion 00	Li-ion battery



DANGER



Don't

Do not connect a wire or other metal objects to the jack. And, do not carry or store FOMA terminal with objects like a metal necklace.

May cause the battery pack to ignite, burst, heat or leak.



Don't

Check the orientation of battery pack to install it to FOMA terminal, and do not try to force the battery pack onto FOMA terminal if you are having trouble installing it.

May cause battery pack to ignite, burst, heat or leak.



Don't

Do not throw the battery pack into the fire.

May cause battery pack to ignite, burst, heat or leak.



Don't

Do not nail the battery pack, hit with a hammer or step on it.

May cause battery pack to ignite, burst, heat or leak.



Do

If the battery pack's fluid etc. contacts eyes, immediately flush the eyes with clean water and see a doctor right away. Do not rub the eyes.

May cause loss of sight.

⚠ WARNING

Don't

If the battery pack seems to have abnormalities such as deformation or scratches due to falling, never use it. May cause battery pack to ignite, burst, heat or leak.



Do

If the battery pack leaks or gives off a strange smell, immediately remove it from the vicinity of open flames. The vapors from leaking battery pack fluid may ignite or explode.



Do

Be careful not to let your pet bite the battery pack. May cause battery pack to ignite, burst, heat or leak.

⚠ CAUTION

Don't

Do not discard old battery packs together with other garbage. May cause igniting or environmental destruction. Tape the terminals of old battery packs to insulate them, and then bring them into a sales outlet such as docomo Shop. If your local municipality has a battery recycling program, dispose of them as provided for.



Don't

Do not use or charge a wet battery pack. May cause battery pack to ignite, burst, heat or leak.



Do

If fluid etc. leaks out from the battery pack, do not make the fluid contact with your skin of face or hands. May cause loss of sight or skin problems. If the fluid etc. put into your eyes or mouth, or contacts skin or clothes, immediately flush the contacted area with clean water. If the fluid put into the eyes or mouth, immediately see a doctor after flushing.

Handling adapter and desktop holder**⚠ WARNING**

Don't

Do not use the adapter cord if it gets damaged. May cause fire, burns, electric shock.



Don't

Do not use the AC adapter or desktop holder in a bathroom or other highly humid area. May cause fire, burns, electric shock.



Don't

Always use the DC adapter with a negative-ground vehicle. Do not plug it into a positive-ground vehicle. May cause fire, burns, electric shock.



Don't

When it starts to thunder, do not touch adapter. May cause electric shock.



Don't

Do not short the charging jack while it is connected to the outlet or cigarette lighter socket. Do not touch the charging jack with a part of your body such as your hand or finger. May cause fire, burns, electric shock.



Don't

Do not place heavy objects on the adapter cord. May cause fire, burns, electric shock.



Don't

When you insert and remove AC adapter from power outlet, do not contact a metal strap or other metal objects with the jack. May cause fire, burns, electric shock.



No wet hands

Do not touch the adapter cord, desktop holder or outlet with wet hands.

May cause fire, burns, electric shock.



Do

Only use with the specified power source and voltage.

When charging FOMA terminal overseas, use AC Adapter for global use.

If incorrect voltage is used, this may cause fire, burns or electric shock.

AC adapter : AC100V

DC adapter : 12 or 24V DC (specific for negative ground vehicle)

AC adapter for global use : Between 100V and 240V AC (Connect to the AC outlet for internal household use)



Do

If the DC adapter's fuse blows, replace it only with the specified fuse.

May cause fire, burns, electric shock. For the specified fuse, see the instructions that come with the DC adapter.



Do

Wipe off any dust that accumulates on the power plug.

May cause fire, burns, electric shock.



Do

When you connect the AC adapter to an outlet, firmly connect to the outlet.

May cause fire, burns, electric shock.



Do

When you disconnect the power plug from the outlet or cigarette lighter socket, do not pull the adapter cord with excessive force. Instead, hold the adapter to disconnect.

May cause fire, burns, electric shock.



Unplug

Always remove the power plug from the outlet or cigarette lighter when not using the adapter for an extended period.

May cause fire, burns, electric shock.



Unplug

Immediately remove the power plug from the outlet or cigarette lighter socket if water or other fluids get into the adapter.

May cause fire, burns, electric shock.



Unplug

Always remove the power plug from the cigarette lighter socket when cleaning the equipment.

May cause fire, burns, electric shock.

Handling docomo mini UIM card



CAUTION



Do

Be careful of the cut surface when removing docomo mini UIM card.

May cause injuries.

Handling touch pen

WARNING



Don't

Do not point the touch pen at a person.

May cause accident such as injury or blindness to yourself or others by hitting.



Don't

When the touch pen is attached to the FOMA terminal, do not swing the terminal by the touch pen.

May cause accident such as injury to yourself or others by hitting.

Handling mobile phones near electronic medical equipment

- These precautions are based on the guidelines produced at the Electromagnetic Compatibility Conference Japan, regarding the protection of electronic medical equipment from radio waves emitted by mobile phone units.

WARNING



Do

Obey the following rules inside medical facilities.

- Do not bring FOMA terminal into operating rooms (ORs), intensive care units (ICUs) or coronary care units (CCUs).
- Turn FOMA terminal OFF in hospital wards.
- Turn FOMA terminal OFF in hospital lobbies and corridors if electronic medical equipment could be nearby.
- If the medical facility has specified zones where use or possession of mobile devices is prohibited, obey those instructions.
- If the function to automatically turn ON the power is set, cancel the setting before turning the power OFF.



Do

Turn FOMA terminal OFF in crowded trains or other public places where pacemaker or defibrillator wearers could be nearby.

FOMA terminal's signals may affect the operation of implanted pacemakers or defibrillators, and other devices.



Do

Wearers of electronic medical equipment such as implanted pacemakers or defibrillators must carry and use FOMA terminal at least 22 cm away from the implanted device.

FOMA terminal's signals may affect the performance of electronic medical equipment.



Do

When electronic medical equipment other than implanted pacemakers or defibrillators are in use outside of medical facilities (such as in home care settings), check with the device manufacturer to determine how the device is affected by electrical signals.

FOMA terminal's signals may affect the performance of electronic medical equipment.

Material list

Part		Material	Surface treatment
Exterior case	Movable part Sub-Display	PC+ABS resin	UV hard coating
	Movable part Display	PA-GF resin	UV hard coating
	Fixed part Keypad	PA-GF resin	UV hard coating
	Fixed part Battery	PC+ABS resin	UV hard coating
	Hinge section Movable side	PC+ABS resin	UV hard coating
	Hinge section Fixed side	PC+ABS resin	UV hard coating
	Back cover	PC+ABS resin, stainless steel, silicon rubber (VMQ)	UV hard coating
	Back cover lock lever	POM resin	None
	Back cover inner plate	Stainless steel	None
Case pad	Urethane acrylate resin	None	
Display panel	Acrylate resin+PET sheet	None	
Back panel	Acrylate resin	UV hard coating	
Back panel decoration parts (only for the F-06D Girls')	ABS resin	UV hard coating	
Camera lens, camera panel	Acrylate resin	UV hard coating	
Side keys	PC resin	UV hard coating	
Keypad	Urethane acrylate resin	UV hard coating	
Open assist button	PC resin	UV hard coating	
Front panel	Polyester film	None	

Part		Material	Surface treatment
External connection jack cap	Body	PC+ABS resin	UV hard coating
	Flexure	Elastomer resin (TPE)	None
	Water stop	PC resin	None
	O ring	Synthetic rubber (EPDM)	None
External connection jack		Stainless steel	Tin plating
Battery contacts	Battery contacts connector	PPS resin	None
	Battery contacts	Beryllium copper	Gold plating (base : Ni-Pd plating)
Screw (battery install recess)		Stainless steel	None
Battery install recess face		PC board	Gold plating
Battery pack	Battery pack	PC resin	None
	Contacts	Beryllium copper	Gold plating
Charging jack	Contacts	Stainless steel	Gold plating
	Attaching holder section	LCP resin	None

Handling precautions

General

- **F-06D is waterproof, however, do not allow water to seep into FOMA terminal and do not allow accessories or optional devices to get wet.**
 - Battery pack, adapter, desktop holder, docomo mini UIM card are not waterproof. Do not use in a bathroom or other highly humid area or do not let rain attached. Or putting the terminal on your body, humidity of sweat may cause internal corrosion and malfunction. Note that malfunctions, which are determined to be caused by water as result of inspections, are not covered by the warranty. Since these conditions are outside the scope of the warranty, a repair, if at all possible, is charged.
- **Clean FOMA terminal with a dry soft cloth (such as a cloth for eyeglasses).**
 - Rubbing it roughly with a dry cloth may scratch the display.
 - Drops of water or dirt left on the display may cause stains.
 - If FOMA terminal is wiped with alcohol, paint thinner, benzine or detergent, the printing may disappear or color may fade.
- **Clean the jack occasionally with a dry cotton swab etc.**
 - If the jack is soiled, connection gets worse and it may cause power to be turned off or insufficient battery charge, so clean the jack with a dry cotton swab etc. Also, be careful never to damage the jack when cleaning it.
- **Do not place FOMA terminal near an air-conditioner outlet.**
 - The rapid change in temperature may cause condensation, causing internal corrosion and malfunction.

- **When using, be careful not to subject excessive force to FOMA terminal or the battery.**
 - If FOMA terminal is crammed into a brimming bag or placed in a pocket and sat on, display, internal PCBs or battery pack may be damaged or malfunction. And, if external devices are plugged into the external connection jack (earphone/microphone jack), the breakage of the connector or malfunction may result.
- **Do not rub or scrape the display with a metal piece etc.**
 - May scratch the display, causing malfunction or damage.
- **Carefully read the separate instructions that come with the battery pack and adapter.**

FOMA terminal

- **Do not press the surface of the touch panel strongly or operate it with sharp objects such as a nail, a ballpoint pen and a pin.**
 - It may damage the touch panel.
- **Avoid extreme temperature.**
 - Use FOMA terminal where the temperature ranges between 5 and 40°C (limited to the temporary use in a bathroom etc. when temperature is above 36°C) and humidity ranges between 45 and 85%.
- **FOMA terminal may affect land-line phones, TVs or radios in use nearby, so use it as far as possible from these appliances.**
- **Maintain a separate record of the data you saved in your FOMA terminal.**
 - If the data is deleted, DOCOMO assumes no responsibility for the loss of any data.
- **Do not drop FOMA terminal or subject it to shocks.**
 - May cause malfunction or damage.
- **Do not plug external devices into the external connection jack (earphone/microphone jack) at a slant, or do not pull it forcibly while it is plugged.**
 - May cause malfunction or damage.
- **Do not close FOMA terminal with the strap etc. held inside.**
 - May cause malfunction or damage.

- **It is normal for FOMA terminal to become warm during use or charging. Continue to use it.**
- **Do not leave FOMA terminal with the camera in areas under strong direct sunlight.**
 - May cause discoloring or burn-in of elements.
- **Use FOMA terminal with the external connection jack cap closed.**
 - Dust and/or water brought into FOMA terminal cause troubles.
- **Do not use FOMA terminal with the back cover removed.**
 - May cause removal of battery pack, malfunction or damage.
- **Do not put extreme thick sticker on the display or keypad face.**
 - May cause malfunction, damage or erroneous operation.
- **While microSD card is being used, do not take the card out and do not turn off FOMA terminal.**
 - May cause data loss or malfunction.
- **Do not bring magnetic cards etc. close to FOMA terminal nor clip it by FOMA terminal.**
 - Magnetic data in cash cards, credit cards, telephone cards, floppy disks, etc. may be erased.
- **Do not bring magnetized objects close to FOMA terminal.**
 - Bringing strong magnetism close may cause a malfunction.

Battery pack

- **The battery pack is a consumable part.**
 - Replace the battery pack if FOMA terminal has extremely short operation time on a full charge, though it may vary by operating conditions. Purchase a new battery pack of the specified type.
- **Charge the battery in an area within the proper ambient temperature range (5-35°C).**
- **The operation time provided by the battery pack varies by the operating environment and battery pack's deterioration.**
- **The battery pack may swell out as it comes to near the end of its lifetime depending on the usage conditions, but it is not a problem.**
- **Be careful especially about the following points when preserving the battery pack.**
 - Keeping under the state of the full charge (right after charging ends)
 - Keeping under the state of the empty charge (too exhausted to turn on FOMA terminal)

They may cause the battery pack performance to be degraded or its lifetime to be shortened.

A recommended battery level to keep the battery pack is the battery icon in 2 cells or in 40 % of remaining battery level as a guide.

Adapter

- **Charge the battery in an area within the proper ambient temperature range (5-35°C).**
- **Do not charge the battery in the areas below.**
 - In areas of excessive humidity, dust or vibrations
 - Near land-line phones or TVs/radios
- **It is normal for the adapter to become hot while charging. Continue to use it.**
- **When using the DC adapter for charging, keep the vehicle engine running.**
 - The vehicle's battery could become flat.
- **When using an outlet with a mechanism preventing unplugging, follow the handling instructions for that outlet.**
- **Do not give strong shock. Do not deform the charging jack.**
 - May cause malfunction.

docomo mini UIM card

- Do not use excessive force to install/remove docomo mini UIM card.
- Note that DOCOMO assumes no responsibility for malfunctions occurring as the result of inserting and using docomo mini UIM card with another IC card reader/writer.
- Always keep docomo mini UIM card ICs clean.
- Clean docomo mini UIM card with a soft, dry cloth (such as a cloth for eyeglasses).
- Maintain a separate record of the data you saved in docomo mini UIM card.
 - If the data is deleted, DOCOMO assumes no responsibility for the loss of any data.
- To preserve the environment, bring the old docomo mini UIM card to a sales outlet such as docomo Shop.
- Take care not to scratch, touch accidentally or short IC.
 - May cause data loss or malfunction.
- Do not drop docomo mini UIM card or subject it to shocks.
 - May cause malfunction.
- Do not bend docomo mini UIM card or place heavy objects on it.
 - May cause malfunction.
- Do not install docomo mini UIM card into FOMA terminal with a label or sticker put on.
 - May cause malfunction.

Touch pen

- Use the included touch pen to operate Graffiti picture.
 - Using tools other than the specified touch pen may damage or contaminate the display.
- Do not use the included touch pen for devices other than the FOMA terminal.
 - May cause malfunction or damage of the devices.

FeliCa reader/writer

- FeliCa reader/writer function of FOMA terminal uses weak waves requiring no licenses for radio stations.
- It uses 13.56 MHz frequency band. When using other reader/writers in your surroundings, keep FOMA terminal away sufficiently from them. Before using the FeliCa reader/writer, confirm that there are no radio stations using the same frequency band nearby.

CAUTION

- Do not use a remodeled FOMA terminal. Using a remodeled terminal violates the Radio Law. FOMA terminal is certified according to technical standard conformance of specified wireless equipment based on the Radio Law, and as a proof of it, the "Technical Compliance Mark" is depicted on the engraved sticker of FOMA terminal. If you remodel FOMA terminal by removing its screws, your certification of technical standard conformance becomes invalid. Do not use FOMA terminal with its certification of technical standard conformance invalid as it violates the Radio Law.
- Be careful when you use FOMA terminal while driving a car etc. Using a mobile phone while driving is subject to penal regulations. However, absolutely necessary cases such as rescue of a sick person or maintaining public's safety are exempted.
- Use FeliCa reader/writer function only in Japan. FeliCa reader/writer function of FOMA terminal conforms to Japanese radio standards. If you use this function overseas, you may be punished.
- Do not alter the basic software. Repair may be refused due to modification of the software.

Waterproofness

F-06D provides waterproofness of IPX5*1, IPX8*2 with firmly closing the external connection jack cap and installing the back cover in a locked state.

- *1 IPX5 means that a phone keeps functioning after applying a jet flow of 12.5 L/min. from every direction from a distance of approximately 3 m for at least 3 minutes using water nozzle in 6.3 mm inner diameter.
- *2 For F-06D, IPX8 means that a phone keeps functioning after F-06D is slowly submerged to depth of 1.5m in static tap water at room temperature, left there for 30 minutes and then taken out, and the mobile phone keeps shooting still images or moving pictures in approximately 30 minutes in static tap water at room temperature.

❖ What you can do with waterproofness of F-06D

- **You can talk or watch 1Seg programs without using an umbrella in the rain (for rainfall of 20 mm or less per hour).**
 - When your hands or FOMA terminal are wet, avoid installing/removing the back cover or opening/closing the external connection jack cap.
- **You can also shoot still images and moving pictures in the pool depth of 1.5 m.**
 - Do not perform other operations underwater than shooting still images and moving pictures.
 - If you put the terminal in water of swimming pool, be sure to have it within 30 minutes.
 - If the FOMA terminal gets wet with water from a swimming pool or soak in water of a swimming pool, wash it in specified procedure and drain water in the following procedure (⇒ P21).

- **You can use FOMA terminal in a bathroom.**
 - Do not put the terminal in the bathtub. Do not use the terminal in hot water. May cause malfunction.
 - Never put FOMA terminal in hot spring water or water containing soap, detergent or bath powder.
- **You can eliminate dirt by shaking the terminal in tap water of wash-basin.**
 - When washing, in locked state with the back cover attached, with pressing and holding the external connection jack cap not to open, wash the terminal without using a brush or sponge.

To ensure waterproofness

To avoid water ingress, be sure to observe the following points.

- Do not throw any liquid other than room-temperature tap water on FOMA terminal, or soak it in such liquid.
- When using the external connection jack, put your finger into the groove as shown to open the cap.

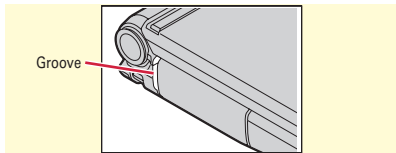

After using the external connection jack, close the cap as the direction shown in the illustration, and make sure that the cap is completely closed without slack by pushing the tabs in.

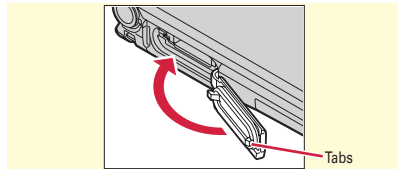

- For installing the back cover, see "Installing back cover" of "Attaching docomo mini UIM card/ battery pack". ⇒P23
- Securely lock the back cover and firmly close the external connection jack cap. Even a fine obstacle (one hair, one grain of sand, tiny fiber, etc.) put between contact surfaces may allow water to enter.
- Do not poke the microphone, earpiece or speaker with a swab or sharp object.
- Do not let FOMA terminal fall. It may become scratched causing the waterproof performance to degrade.
- The external connection jack cap and the rubber packing of the rear side of the back cover play an important role for keeping waterproof performance. Do not deform the back cover by twisting etc. or peel off or damage the rubber packing. Also, prevent dust from adhering to it.

● ● ●
To keep FOMA terminal waterproofness, replacement of parts is required every 2 years regardless of whether FOMA terminal appears normal or abnormal. DOCOMO replaces the parts as a chargeable service. Bring FOMA terminal to a sales outlet such as a DOCOMO-specified repair office.

Important precautions

Do not perform actions shown in the illustrations below.

<Examples>



Using Soap/Detergent/
Bath powder



Washing brush/
sponge



Machine-washing



Applying strong
water flow



Soaking ocean
water



Using hot spring
water



Attaching sand/
mud

Observe the following precautions to use FOMA terminal properly.

- Accessories and optional devices are not waterproof. When watching 1Seg etc. with FOMA terminal installed in the included desktop holder, do not use it in a bathroom, shower room, kitchen or lavatory even if it is not connected to the AC adapter.
- Do not apply water flow stronger than allowed (⇒P19) (e.g., such water flow that gives you pain when applied to your skin directly from a faucet or shower). F-06D provides IPX5 waterproof performances. However, it causes malfunction.
- Do not put FOMA terminal in hot water, use it in a sauna or apply hot airflow (from a hair dryer etc.) to it.
- Do not move in water or slam the terminal against the surface of water with FOMA terminal opened.
- If you put the terminal in tap water or in water of swimming pool, be sure to have it within 30 minutes.

- When you use the terminal in swimming pool, obey rules of the facility.
- FOMA terminal does not float on water.
- Do not leave water on FOMA terminal. May short-circuit the power jacks, or in a cold region, water may freeze causing malfunction.
- Do not leave water on the microphone, earpiece or speaker. Such water may interfere with talking.
- If the back cover is damaged, replace it. Water may enter inside from a damaged section causing troubles such as electric shocks or corrosion of the battery.
- If FOMA terminal gets wet with water or other liquids with the external connection jack cap or the back cover open, the liquid may get inside the terminal causing electric shocks or malfunction. Stop using FOMA terminal, turn the power OFF, remove the battery pack and contact a DOCOMO-specified repair office.
- If the external connection jack cap, or the rubber gasket on the rear side of the back cover is damaged or deformed, replace it at DOCOMO-specified repair office.

● ● ●
 DOCOMO does not guarantee actual operations under all states. Malfunctions deemed to be caused by inappropriate operation by the customer are not covered by the warranty.

Draining water from FOMA terminal

When FOMA terminal is wet, water may flow out after wiping it off; drain the water in the following steps.

- ① Wipe off moisture on the FOMA terminal surface and back side with dry, clean cloth etc.



- ② Shake FOMA terminal approximately 20 times, firmly holding its hinge section, until there is no more water splattering.

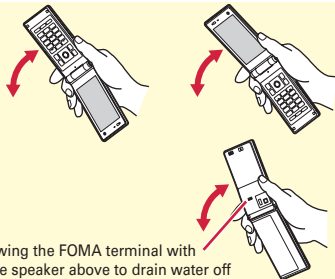

- ③ Press lightly the FOMA terminal against dry, clean cloth etc. about 10 times to wipe off water remaining in the microphone, earpiece, speaker, keypad, hinges or charging jack, etc.

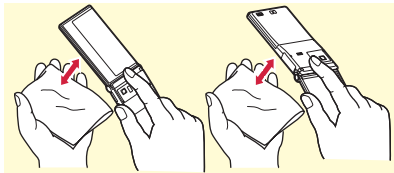

- ④ Wipe off water drained from FOMA terminal with dry, clean cloth etc., and dry naturally.
- Water, if any, remaining in FOMA terminal may ooze up after wiping off.
 - Do not wipe off water remaining in gaps directly with a cotton swab etc.

Charging

Check the following before and after charging.

- Check if FOMA terminal is not wet. Never try to charge the battery pack when FOMA terminal is wet.
- Accessories and optional devices are not waterproof.
- When charging the battery when or after FOMA terminal is wet, adequately drain it and wipe off water with a dry, clean cloth etc., before connecting the accessory desktop holder or opening the external connection jack cap.
- When the external connection jack cap is opened for charging, close the cap firmly after charging. It is recommended to use the desktop holder for charging to prevent water from seeping inside from the external connection jack.
- Do not use the AC adapter or desktop holder in a bathroom, shower room, kitchen, lavatory or other highly humid area. May cause fire or electric shock.
- Do not touch the AC adapter or desktop holder with wet hands. May cause electric shock.

Attaching docomo mini UIM card/battery pack

After turning power OFF, close FOMA terminal and hold it in your hand so that you can properly attach docomo mini UIM card/battery pack.

❖ Removing back cover

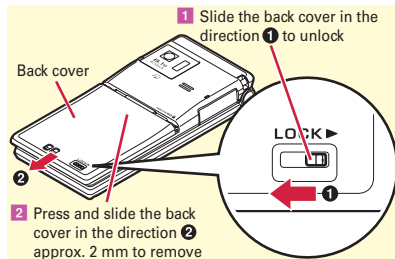

❖ Attaching docomo mini UIM card

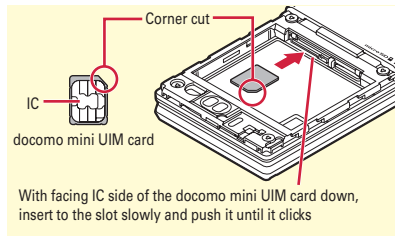

Point

- Only docomo mini UIM card is available for the FOMA terminal. If you have a UIM or FOMA card, bring it to a docomo Shop to replace.

❖ Installing battery pack

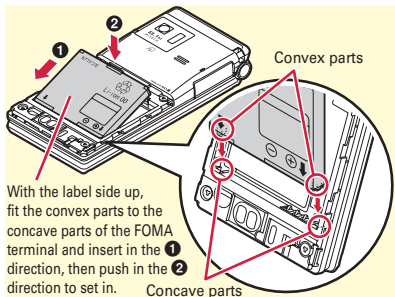

❖ Installing back cover

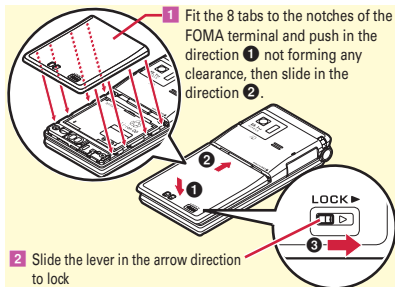

Point

- Make sure the locations of the slots for docomo mini UIM card and microSD card. If the cards cannot be removed, bring the FOMA terminal to a docomo Shop.

Charging

The battery pack does not have a full charge at time of purchase. Use AC adapter for FOMA terminal to charge the battery before using FOMA terminal.

Charging using desktop holder

- 1** Insert the connector of AC adapter horizontally to the accessory desktop holder, with the arrows mark side upward
- 2** Unfold the power plug and insert it into a 100V AC outlet
- 3** Close FOMA terminal and insert it into the desktop holder
- 4** Check that the charging light turns on

* After charging is completed, remove FOMA terminal from the desktop holder.

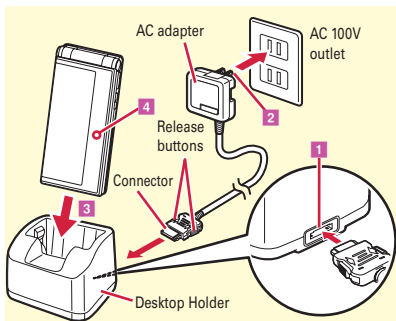

Charging using AC adapter

- 1** Open the external connection jack cap (①), hold the connector horizontally with the arrows side upward and insert it to the jack (②)
- 2** Unfold the power plug and insert it into a 100V AC outlet
- 3** Check that the charging light turns on

* When charging is over, pull out the power plug from the outlet, and pull out from FOMA terminal horizontally while pressing the release buttons on both sides of the connector.

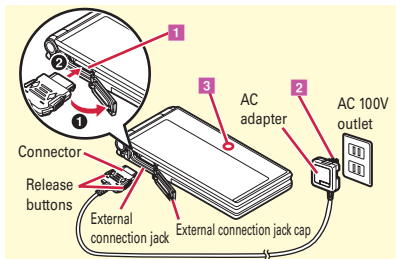

Before Using

Power ON - Default setting

Initial setting is an operation when FOMA terminal is turned ON for the first time.

1 (2 sec. or more)

The Initial setting screen appears.

2 **Set required items** [Complete]

If you exit without setting Change security code and Request permit/deny., Initial setting screen reappears when the power is turned ON the next time.

3 **On a confirmation screen of software update function,** **On the confirmation screen of Error info send set.,**





The stand-by display appears.

If Machi-chara asks you how to call you (user name), press  twice to enter user name.

Point

- If no operation is performed, the display light is automatically turned off according to the settings in Light time-out or eco mode setting. The display light turns on again if there is any operation or incoming call.
- The battery usage state is automatically recorded while using the FOMA terminal. The record is used only for repair diagnosis.

Turning power off :  (2 sec. or more)

Changing the initial setting :    

Changing screen display to English :

    ▶ Select "English"

Before Using

Caller ID notification

Set whether to notify your phone number (caller ID) to the other party's terminal when making a voice call.

1 **TEL function** **Dial/Receive call setting** **Caller ID notification** **Setting** **ON** or **OFF**

Point

- If you hear an announcement of requesting caller ID when making a call, set Caller ID notification or add prefix "186" to the phone number to call again.

Before Using

Checking Profile

Check a model name or own phone number.

1 **Profile**



User information screen appears.

Point

Editing the profile : On User information screen,

 ▶ **Authenticate** ▶ **Set required items** 

- On the profile edit screen, select first mail address then select "Acquire Auto" to obtain your mail address from the i-mode center. For details of changing a mail address, refer to "Mobile Phone User's Guide [i-mode] FOMA version".

Checking a phone number during a call :  

Viewing display

New arrival information and current state can be checked by the icon appearing on the screen. Major icons are as follows.

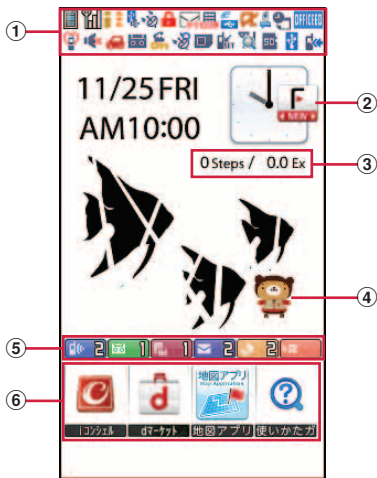

*くまん (Kuman)
©Dora communications

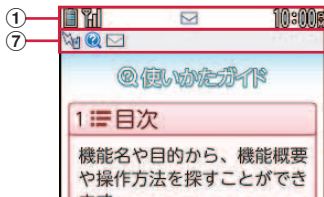

① Status area

Status icons are displayed. Select an area on the stand-by screen to display icon details screen. Battery level (Battery icon)



Signal strength (Antenna icon)

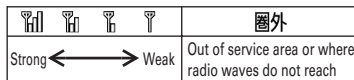

SELF : Self mode ON

: In data transfer mode

: Connecting to i-mode

: Infrared communication in operation

: The total calls cost exceeds the limit

: Communication using handsfree-compatible device in progress

: Handsfree ON

: Femtocell available

: Positioning with GPS

: Location request setting

: A phonebook entry, memo or schedule has secret attribute

: Personal alarm ON

: Kid-safe mode ON























: Unread Area Mail exists

: In-area auto-send mail exists

: Unread i-mode mail exists

: Arrival i-concier information exists

: Unreceived i-mode mail exists in the Center

-  : Using Smart Browser
-  : Music&Video Channel program obtaining reservation exists
-  : During i-appli operation
-  : i-appli call exists
-  : Communication mode ON (USB cable connected)
-  : Alarm is set
-  : 1Seg watching/recording reserved or alarm of Memo is set
-  : Inside OFFICEED area
-  : Manner mode ON
-  : Call alert volume OFF
-  : Vibration mode for voice call ON
-  : In Public mode (Drive mode)
-  : Record message setting ON
-  : Keypad dial lock ON
-  : Personal data lock ON
-  : IC card lock ON
-  : Recording 1Seg in the FOMA terminal
-  : eco mode ON
-  : microSD card inserted
-  : Connected to external device using USB cable
-  : Pedometer/ACT monitor is set
-  : Software update rewrite notice
-  : Auto-update of latest pattern definition failure

② Update notification of MyFACE⇒P29

③ Pedometer/ACT monitor



Steps and activity of the day are displayed.

④ Machi-chara

Characters moving about the screen and giving messages. In addition to the preinstalled characters, you can obtain characters by downloading.

⑤ New arrival



Starting from the left, missed call, recorded message, message in voice mail service, unread mail, unread ToruCa, i-appli call
 Select an arrival information etc. on the stand-by display using  and  to quickly display the corresponding information (Focus mode).

⑥ Shortcut⇒P29

⑦ Task area

Icons indicating running features (tasks) appear.

Basic operations for screen and keys

Menu operation

On the stand-by display, select **MENU** and perform a function from the menu. You can select a menu item with shortcut operations which use the keypad, etc. or with multi-cursor operation which uses the multi-cursor key to move the cursor.

<Example> Selecting "Calculator"

Shortcut operations

1 **MENU** ▶ **6** ▶ **2**

Multi-cursor key operations

1 **MENU** ▶ Move the cursor to "**6** Tool" ▶
[OK] ▶ Move the cursor to
 "**2** Calculator" ▶ **[OK]**

Point

- To return to the previous screen, press **[CLR]**. To return to the stand-by display, press **[]**.

Guide area

Operations that can be performed by pressing **MENU**, **[]**, **[]**, and **[]** are displayed in the guide area.

* Terms indicated with

[] in the

instructions of this manual are items displayed in the guide area.

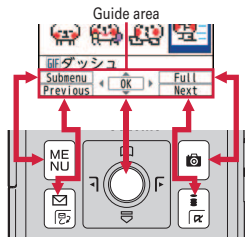

docomo Palette UI

MyFACE

In the right and left area of the stand-by display, up to 12 MyFACES downloaded from sites, etc. can be pinned.

1  or 

Switch screens one after another in the same way to display MyFACE you want to use.

**Point**

- Packet communication charges apply to refresh content for other than MyFACES set by default. Note that using MyFACES set by default is also charged if the i-mode access point is changed or while international roaming.

Shortcut

Select a shortcut icon to activate a function. Move the cursor on a shortcut icon and press  to display a shortcut list.

使いかたガイド (Guide)

You can check outline of function, operations or troubleshooting. (In Japanese only)

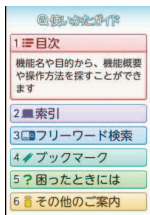
1  **MENU** ▶ 6  **Tool** ▶ #  **Guide** ▶ Select a search method

<Guide screen>

目次 (Contents) : Search from a list of functions.

索引 (Index) : Search from a list of words sorted according to Japanese syllabary.

フリーワード検索 (Free word search) : Enter a keyword to search for.

ブックマーク (Bookmark) : Search from a list of registered bookmarks.

困ったときには (Troubleshooting) : Search from lists of troubles or error messages.

その他のご案内 (More information) : Access to guide page introducing useful site.

Point

- On a description screen, select "この機能を使う (Use this function)" to perform a function. Selecting a link item in "関連機能 (related functions)" or "→コチラ (See more)" displays a corresponding description screen.

Entering characters

5-touch input and conversion



5-touch input is an input method to switch a character by pressing a key repeatedly.

1 Enter character on the character entry screen

When a character is entered, the cursor automatically moves in a regular interval. To quickly enter characters assigned to an identical key consecutively, press .



<Example> Entering "ろっぽんぎ"

"ろ":  (5 times)

"っ":  (3 times) ▶ 

"ぽ":  (5 times) ▶  (twice)

"ん":  (3 times)

"ぎ":  (Twice) ▶ 

Conversion options appear at the bottom of the screen. You can select a character from the options by pressing .



2 [Convert]

Characters on the character entry screen are converted. Press  again to display a conversion options list.

Point

- You can enter a character by pressing 2 keys in combination (2-touch input).

<Example> Entering "ろっぽんぎ" by 2-touch input

"ろ":  

"っ":    

"ぽ":      

"ん":  

"ぎ":    

Operations during character entry

Returning to the previous character : 

Deleting characters : 

Adding voiced/semi-voiced sound or switching upper/lower case : 

Switching input modes

- On the character entry screen, press  ▶ Select "Hiragana/Kanji", "Katakana", "Alphanumeric", "Number", etc. from the Switch input mode palette

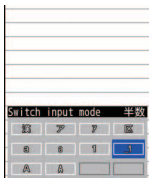

<Switch input mode palette>

Text input

Set a text input method or operation during text entry.

- 1 [MENU] ▶ 8 Setting ▶ 4 Text display/
input ▶ 3 Text input ▶ 1 Text input
method ▶ Set required items ▶ 
[Set]



Useful functions on the entry screen

Useful functions on the entry screen are explained taking mail message editing screen as an example.

Entering common phrases

- 1 [MENU] [Submenu] ▶ 5 Quote phrase/
data ▶ 2 Phrase ▶ Select phrase type ▶
Select a phrase

Entering pictograms/symbols

- 1 On the character entry screen, when
[Pict/Sym] is displayed,  [Pict/
Sym] ▶ Select a pictogram
On the pictogram selection screen, press [MENU] to
display one-byte symbols/two-byte symbols,
press  to display pictogram D (Deco-mail
pictograms)/pictograms/D pictures (Deco-mail
pictures). Press  on the pictogram D
selection screen to select a category.

Entering smileys

- 1 [MENU] [Submenu] ▶ 5 Quote phrase/
data ▶ 0 Pict/Symbol/Smiley ▶ 3
Smiley ▶ Select a smiley type ▶ Select a
smiley

Copying/Cutting, pasting characters

- 1 [MENU] [Submenu] ▶ 4 Copy/Cut/etc. ▶
1 Copy or 2 Cut ▶ Specify the area
using the multi-cursor key
- 2 [MENU] [Submenu] ▶ 4 Copy/Cut/etc. ▶
3 Paste ▶  [Paste]

Sound settings

You can set tones, such as changing a ring alert, adjusting the volume, or muting the sound emitted from FOMA terminal.

Ring tone

You can set your favorite melody, etc. for a ring alert.

<Example> Setting voice call ring tone

- 1 ► 8 **Setting** ► 2 **Sound/Vibration/Manner** ► 1 **Ring tone** ► 1 **Call ring tone** ► **Set required items** ► **[Set]**

Point

- When Voice call ring tone is set, the setting applies to Incoming call.
- Some music or moving pictures/i-motion may not be set to the ring alert.

Adjust volume

You can set the volume of a ring alert, alarm sound, etc.

- 1 ► 8 **Setting** ► 2 **Sound/Vibration/Manner** ► 3 **Adjust volume** ► **Select an item** ► or ► **[Select]**

Vibration mode

You are notified of an incoming call or alarm with vibration, instead of sound.

- 1 ► 8 **Setting** ► 2 **Sound/Vibration/Manner** ► 4 **Vibration mode** ► **Select an item** ► **Select vibration**

Silent mode

This function mutes the sound emitted from the FOMA terminal such as ring alert, Keypad sound, open/close operation sound, Alarm sound, confirmation sound for reading a code with Bar code reader, and notifies incoming calls with vibrator (vibration). The microphone is sensitized in Silent mode, and you can call in a small voice.

- 1 **(1 sec. or more)**
 appears on the stand-by display in Silent mode.
Canceling Silent mode : (1 sec. or more)

Point

- Shutter sound, Auto focus lock sound for shooting still pictures, and count down sound of Auto timer are emitted even in Silent mode.

System sound

Set sounds emitted for key operation, opening/closing the FOMA terminal, and shutter sound for shooting still images or moving pictures (including recording for Voice recorder).

- 1 ► 8 **Setting** ► 2 **Sound/Vibration/Manner** ► 2 **Other sounds** ► 4 **System sound** ► **Select an item** ► **Select sound**

Point

- Even if the key touch sound is set to sound, no sound is made while i-appli is activated.

Setting display

Stand-by display setting

You can change the default stand-by display.

<Example> Setting an image

- 1 **MENU** ▶ 8 **Setting** ▶ 1 **Screen/Display**
 ▶ 2 **Stand-by display setting** ▶ 1
Image/i-appli ▶ 1 **Set image**

When Kisekai Tool is set, select "Yes" on the confirmation screen for canceling.

- 2 **Select a folder** ▶ **Move the cursor to an image** ▶  **[OK]** ▶ "Yes"

Display light

You can set the brightness of screen and Light time-out.

- 1 **MENU** ▶ 8 **Setting** ▶ 3 **Backlight/Illumination** ▶ 1 **Display light** ▶ **Select an item** ▶ **Select time or action**

Privacy view

This function allows the display to be less-visible to the people around you. You can start/cancel on the screen other than the stand-by display.

- 1 **MULTI** (1 sec. or more)
Canceling Privacy view : **MULTI** (1 sec. or more)

Select startup menu

Select a menu to be displayed when **MENU** is pressed on the stand-by display from "Normal menu (according to Kisekai Tool)", "Basic menu (menu structure and menu numbers are fixed)" or "Shortcut menu (changeable menu items)".

- 1 **MENU** ▶ 8 **Setting** ▶ 1 **Screen/Display**
 ▶ 7 **Menu preference** ▶ 1 **Select startup menu** ▶ **Select a menu type**

Font size

- 1 **MENU** ▶ 8 **Setting** ▶ 4 **Text display/input** ▶ 1 **Font size** ▶ **Set required items** ▶ **Select font size**

For some font sizes selected for overall, a confirmation screen for changing the MENU font size appears. When pressing "Yes", Kisekai Tool can be selected.

Point



- Items do not support the font size selected for overall are set to the closest font size.

Setting Machi-chara

You can set a character to be displayed on the stand-by display. A message can be changed to the speech in Machi-chara talk expression. You can also use Friendly message support Machi-chara that displays a message according to the FOMA terminal condition or content of entered text. "リーフロボット", "くーまん" and "バカボンのパパ" stored by default are the friendly message support Machi-chara.

©Dora communications

©赤塚不二夫／びえろ

- 1  ▶ 8 **Setting** ▶ 1 **Screen/Display**
▶ 6 **Machi-chara setting** ▶ 1 **Display setting** ▶ **Set required items** ▶ 
[Set]

Point



- Machi-chara does not appear when i-appli stand-by display is set or while playing moving picture/i-motion set for the stand-by display.
- If you set friendly message to "ON", Machi-chara asks your call name (user name) when you return to the stand-by display. Press  twice to enter your user name. User name is stored for each Machi-chara. If you perform Reset all information from the submenu on the Machi-chara list in the Data Box, stored user name is deleted.

Sound/Screen Setting

Kisekai Tool

You can set the stand-by display, menu, incoming/outgoing call screens, etc. at once with a predefined combination. By default, Kisekai Tool matched to the FOMA terminal color is set.

<Example> **Setting preinstalled Kisekai Tool**

- 1  ▶ 5 **Data Box** ▶ 8 **Kisekai Tool** ▶
3 **Preinstall**
To display details of the Kisekai Tool, select a Kisekai Tool. To display the image of coordinate, select "Preview".
- 2 **Move the cursor to a Kisekai Tool** ▶
 [Setting] ▶ "Yes"

Light setting

Indicator light

You are notified of missed call or unread mail (including SMS) by the indicator light.

- 1 **MENU** ▶ 8 **Setting** ▶ 1 **Screen/Display**
 ▶ 5 **Each display setting** ▶ 4 **Info display & light** ▶ 2 **Indicator light** ▶
 1 **ON** or 2 **OFF**

Point

- The indicator light blinks at approximately 10 seconds interval. However, when you receive information with the FOMA terminal closed or you open the FOMA terminal and close without checking the arrival information, the indicator light blinks at approximately 30 minutes interval.

Light alert

You can set the light operation that is turned on for incoming call or during a call.

<Example> Setting all illuminations

- 1 **MENU** ▶ 8 **Setting** ▶ 3 **Backlight/illumination** ▶ 2 **Light alert** ▶ 1 **All Setting** ▶ **Select an item**

eco mode

Save the battery power by adjusting the display backlight or sound temporarily.

- 1 **MENU** ▶ 8 **Setting** ▶ 7 **Battery** ▶ 1 **eco mode setting** ▶ 1 **eco mode ON/OFF** ▶
 1 **ON** or 2 **OFF**

When ON is set,  appears on the stand-by display.

Point

- If you do not change the default Shortcut menu setting, press **[5]** for 1 second or more to switch eco mode to ON/OFF.

eco mode auto-start set.

eco mode is automatically switched to ON/OFF according to the battery level.

- 1 **MENU** ▶ 8 **Setting** ▶ 7 **Battery** ▶ 2 **eco mode auto-start set.** ▶ **Set required items** ▶  **[Set]**

Point



- You can set operations when eco mode is "ON" in eco mode options.
Std. saving : Change settings of System sound, Light alert, Indicator light, Backlight, 1Seg eco mode, etc. to save the battery power.
Full saving : With Std. saving applied, change the settings for motion sensor, Auto light on, Machi-chara, AUTO-GPS, Pedometer/ACT monitor, etc. to save the battery power.

Security codes

Security codes vary by functions. Security code protects personal information. Be careful about handling the security code.

Terminal security code (Default : 0000)

The code is the security code to be used when changing settings or deleting all the items at once. To change the code, perform the following operation.

- 1  ▶ **8 Setting** ▶ **6 Lock/Security** ▶ **3 Change security code** ▶ **Authenticate**
- 2 **Enter a new terminal security code** ▶
Enter the new terminal security code in
New terminal security code-check field
▶  **[Save]**

Point

- If a wrong terminal security code is entered 5 times consecutively, the power is turned OFF.

Network security code (At subscription : Set any code)

Network security code is required when DOCOMO identifies the subscriber at docomo Shop, docomo Information Center or "お客様サポート (user support)" or when you subscribe Network Services. To change the code, perform the following operation.

- 1  ▶ "お客様サポート (User support)" ▶ "各種設定 (確認・変更・利用) (Settings (Check/Change/Use))" ▶ "ネットワーク暗証番号変更 (Change Network security code)" (in Japanese only)

i-mode password (At subscription : 0000)

i-mode password is required to save to/delete My Menu, use Message Service, subscribe/cancel i-mode charged services, etc. To change the code, perform the following operation.

- 1  ▶ "お客様サポート (User support)" ▶ "各種設定 (確認・変更・利用) (Settings (Check/Change/Use))" ▶ "iモードパスワード変更 (Change i-mode Password)" (in Japanese only)

PIN1/PIN2 code (At subscription : 0000)

You can set 2 security codes to the docomo mini UIM card: PIN1 code and PIN2 code.

The PIN1 code is a security code to be used when installing the docomo mini UIM card or turning ON the FOMA terminal.

The PIN2 code is the security code to be used when requesting the issuance of a user certificate, resetting Total calls cost or resetting the total call costs.

To change either code, perform the following operation. When changing PIN1 code, set PIN1 entry ON/OFF to "ON" in advance.

- 1** [MENU] ▶ **8** **Setting** ▶ **6** **Lock/Security** ▶ **9** **UIM setting** ▶ **1** **Change PIN1 code**
or **2** **Change PIN2 code** ▶ **Authenticate**
- 2** **Enter the current PIN code** ▶ **Enter a new PIN code in New PIN code field and New PIN code - check field** ▶ [OK] [Save]

Point

- To display the PIN1 code entry screen when turning power on, [MENU] ▶ [8] [6] [9] [3] [1], and then set PIN1 entry ON/OFF to "ON".
- Even if PIN2 code is locked by entering incorrect PIN2 code 3 times consecutively, making/receiving calls or sending/receiving mail is available; if PIN code is locked by entering incorrect PIN code 3 times consecutively, these operations are unavailable.

The PUK code

PUK code is used if the PIN1/PIN2 code is locked. PUK cannot be changed by users. If the docomo mini UIM card is locked by entering the PUK code incorrectly 10 times consecutively, contact docomo Shop.

Point

- The PUK code is written on a subscription form (copy for user) handed at subscription in a docomo Shop. For users subscribed in other than docomo Shop, bring a document (a drivers license etc.) to identify your subscription and the docomo mini UIM card to a docomo Shop, or contact "General Inquiries" on the last page of this manual.

- To set a security code, avoid imaginable numbers such as "birth date", "a part of phone number", "street address or room number", "1111" or "1234". Maintain a separate record not to forget the numbers.
- Be careful never to reveal your security code to others. If a security code is known to and misused by others, DOCOMO assumes no responsibility for damages resulted from it.
- If you forget your security codes, you need to bring a document (a drivers license etc.) to identify your subscription, the FOMA terminal and the docomo mini UIM card to a docomo Shop. For details, contact "General Inquiries" on the last page of this manual.

Various lock functions

All lock

Menu operation is unavailable. You can use only a part of operations such as answering calls, receiving mails, turning power ON/OFF.

Activate : **MENU** ▶ **8** **6** **1** **2** ▶ Authenticate

Deactivate : Enter terminal security code

Self mode

All functions requiring communication are unavailable.

Activate/Deactivate : **MENU** ▶ **8** **9** **1** ▶ **1** or **2**
▶ "Yes"

Keypad dial lock

Calls can be made only by using phonebook.

Activate/Deactivate : **MENU** ▶ **8** **6** **1** **4** ▶
Authenticate ▶ **1** or **2**

Auto-key lock

❖ Lock on close

Each time the FOMA terminal is folded, keys are locked. But the side key operations are available when the FOMA terminal is folded.

Activate : **MENU** ▶ **8** **6** **1** **1** **1** ▶ Authenticate ▶
Set required items ▶ 

Deactivate temporarily : Open the FOMA terminal and authenticate

❖ Unoperated lock setting

Lock key operation when no operation is performed for a certain period of time.

Activate : **MENU** ▶ **8** **6** **1** **1** **2** ▶ Authenticate ▶
Set required items ▶ 

38 Unlock temporarily : **MENU** ▶ Authenticate

IC card lock

Osaifu-Keitai, obtainment of ToruCa from IC card reader, iC transmission, etc are unavailable.

Activate/Deactivate : **MENU** ▶ **#** **4** **1** ▶
Authenticate ▶ **1** or **2**

Omakase Lock

The personal data of phonebook etc. or IC card function of Osaifu-Keitai is locked only by contacting DOCOMO in case FOMA terminal is misplaced etc. For details, refer to "Mobile Phone Users Guide [Basic Usage]".

■ Setting/Canceling Omakase Lock

 0120-524-360 Business hours : 24 hours (open all year round) (In Japanese only)

- * Unavailable from part of IP phones.
- * Omakase Lock can be set/canceled from My docomo site using a PC etc. (in Japanese only)

Incoming call restriction

Call rejection setting

Call reject setting allows you to reject calls from phone numbers not saved in phonebook and reject or accept calls from the specified numbers. In addition, you can set a receiving operation for each reason for hiding caller ID.

- 1 **MENU** ▶ 7 **TEL function** ▶ 4 **Dial/Receive call setting** ▶ 9 **Call rejection setting** ▶ **Perform the necessary operation**

Point

- Unregistered caller setting is available for calls showing caller ID. For calls hiding caller ID, receiving operation is performed according to the call reject setting for Anonymous, Payphone, Unavailable. It is recommended that you use both Caller ID request and call reject setting for Anonymous, Payphone, Unavailable.
- The reasons for hiding caller ID are as follows:
Anonymous : a call with hiding caller ID set
Payphone : a call from public payphone, etc.
Unavailable : a call unavailable to notify caller ID such as an overseas call or call from land-line phone using call forwarding service, etc.

Resetting to default

Reset

You can restore functions in **red characters** on the menu list to the default settings. ⇒P82

- 1 **MENU** ▶ 8 **Setting** ▶ 9 **Other setting** ▶ 4 **Reset** ▶ **Authenticate** ▶ **Select an item to reset** ▶  **[Reset]** ▶ "Yes"

Delete all data

You can delete data saved in FOMA terminal, and restore the each function's settings to the default.

- 1 **MENU** ▶ 8 **Setting** ▶ 9 **Other setting** ▶ 3 **Delete all data** ▶ **Authenticate** ▶ "Yes"



All data is deleted while restarting. Do not turn power off until the stand-by display is displayed.

Point

- Even after all data is deleted, the data registered by default is not deleted.

Making a call/videophone call

Entering a phone number



- 1 Enter a phone number including area code (Up to 80 digits)** ▶  (voice call) or  (videophone call) ▶ When ending the call, 

Point

- Do not cover the microphone during a call.



Using phonebook



- 1**  ▶ **Search phonebook**

The phonebook list search result of the Show all names is displayed by default. You can switch lines by  or switch the pages by  / .

- 2 Move the cursor to the party** ▶ 

To make a videophone call, move the cursor to the party and operate as follows.





From Show all names :  ▶   ▶ In the



Call type field,  ▶ 

From other search : 

Point

- You can make calls using logs of mails, etc. if phone numbers are saved in phonebook.
- When mail address is registered to the phonebook, you can create i-mode mail from the phonebook list.



Creating mail from Show all names :  ▶ Search phonebook ▶ Move the cursor to the party ▶  ▶  

Creating mail from other search :  ▶ Search phonebook ▶ Move the cursor to the party ▶ 

Using redial/received calls

Up to 30 items can be displayed in Redial and Received calls respectively. When the maximum number is exceeded, older logs are overwritten.

- 1**  ▶  **TEL function** ▶ **3** **Dialed/Received calls** ▶ **1** **Received calls** or **2** **Redial**

- 2** **Move the cursor to a party** ▶  **(Voice call)** or  **(Videophone call)**

Point

- DOCOMO videophone specifications conform to "3G-324M, an international standard prepared by 3GPP". The connection with the videophones of different specifications cannot be established.

Koe-no-Takuhaibin

Koe-no-Takuhaibin is a service sending messages using voice call. Between 2 FOMA terminals, messages can be recorded or played without calling a party. Notification is sent by SMS when a message is recorded or the party plays recorded message (only when the party sets play notification to on. It is set to on by default). For details, refer to NTT DOCOMO website.

Recording a message

Select a party and record a message in the Koe-no-Takuhaibin service center.



- 1 Enter a phone number** ▶  [Koetaku]
▶ **Follow the guidance of Koe-no-Takuhaibin service center to operate**

Point

- To make a call from Redial, Received calls or Phonebook via Koe-no-Takuhaibin, press .

Checking message/Sitting services

You can check messages or set service such as Koe-no-Takuhaibin by using SMS, Koe-no-Takuhaibin website, the voice prompts.

- Check messages via SMS :**  ▶ **1** ▶ Select a folder ▶ Select an SMS to view ▶ Select "再生 (Play)" ▶ 

Check messages/Set service from website :

 ▶ **7** **8** **1** ▶ "Yes"

Check messages/Set service using voice prompt :

 ▶ **7** **8** ▶ **2** or **3** ▶ "Yes"

International calls

You can make international calls from Japan using WORLD CALL.

❖ WORLD CALL

"WORLD CALL" is the international call (voice call/ videophone call) service available from DOCOMO mobile phones. You are subscribed to "WORLD CALL" at the time of subscription to the FOMA service (Unless you request not to subscribe to it).

- No subscription or monthly charges apply.
- DOCOMO charges customers for "WORLD CALL" fee and monthly FOMA service call fee all together.
- For details of "WORLD CALL", contact "General Inquiries" on the last page of this manual.
- To use international call services except DOCOMO service, contact the carrier for details.
- For countries and overseas telecommunications carriers available, refer to "Mobile Phone User's Guide [International Services]" or DOCOMO International Services website.
- The image of the other party displayed on FOMA terminal may be distorted or connection may not be established depending on the other party's terminal connected through the international videophone line.

- 1 Enter "010-phone number without the leading 0 of Country code (City code)"** ▶  (voice call) or  (videophone call)

In some countries and areas such as Italy, "0" is required.

Call Telephone

Receiving a call/videophone call

1 Receive

You are notified of an incoming call with ring alert, light alert, etc. On the display, the phone number appears when caller ID is sent, and caller's name appears when phone number is saved in the phonebook. When caller ID is not sent, the reason (Anonymous, Payphone or Unavailable) appears.

 : Adjust the alert volume

 : Stop the ring alert and vibrator

 : On-hold

2 (voice/videophone call) or (videophone call)

3 When ending the call,

Point

- When you cannot answer an incoming call,  2 (The digit indicates the number of missed calls) appears on the stand-by display. The incoming calls are recorded as missed calls in Received calls.

Call Telephone

Operation during a call

You can use useful functions during a call.

On hold



A melody is played while on hold. For a videophone call, the videophone on-hold image is displayed on the phone of the other party and yourself.

1 During a call, [OnHold]

Point

Canceling the voice call on hold :  or 

Canceling the videophone call on hold (send the image before on hold) : 

Canceling videophone call on hold (send the camera image) :  or 

Canceling videophone call on hold (send a substitute image) : 

Listening volume

You can adjust listening volume during a call.

1 During a call, or

Point

- This setting applies to Listen volume in Adjust volume.

When you cannot answer a call





Record message

When Record message is set to "ON", a greeting message is played and the caller can record message when you cannot answer the call.

- 1 **MENU** ▶ **7 TEL function** ▶ **2 Record message/Voice memo** ▶ **4 Record message** ▶ **1 ON**

 appears on the stand-by display.

Point

- You can record up to 4 voice/videophone calls in total, approximately 30 seconds for each call. When reaching the savable number,  appears on the stand-by display and Record message does not work. Delete unnecessary recorded messages.
- Even when Record message is not set to "ON", you can activate it only once by pressing  for 1 second or more while receiving a call (Quick recorded message).
- Even when the greeting message is being played or a message is being recorded, you can answer a call by pressing  (for videophone call,  / ). In this case, the message before the call was answered cannot be recorded.

Setting a response time : **MENU** ▶ **7** **2** **4** **3** ▶ Enter time

Playing a recorded message : **MENU** ▶ **7** **2** **1** ▶ Select a message ▶ Select whether to delete

Public mode

Public mode is an automatic answering service putting emphasis on manners in a highly public place or when driving a car.

Public mode (Drive mode)

When there is an incoming call, a guidance message is played to inform the other party of the reason that you cannot answer the call and request to call back, and then the call ends automatically.

- 1  (1 sec. or more)

 appears on the stand-by display.

Point

- In Public mode (Drive mode), no receiving action is performed, and calls are recorded as Missed call.

Canceling :  (1 sec. or more)

Public mode (Power OFF)

When there is an incoming call while turning off the power, a guidance message is played to inform the other party of the reason that you cannot answer the call and request to call back, and then the call ends automatically.

- 1 **Enter "*"25251"** ▶ 

Even when Public mode (Power OFF) is set, no indicators such as icons appear on the display.

Point

Canceling : Enter "*"25250" ▶ 

Checking the settings : Enter "*"25259" ▶ 

Network Services

Service	Application	Monthly charge
Voice Mail Service	Required	Charged
Missed Call Notification Service	Not required	Free
Call Waiting Service	Required	Charged
Call Forwarding Service	Required	Free
Nuisance Call Blocking Service	Not required	Free
Caller ID Notification Service	Not required	Free
Caller ID Display Request Service	Not required	Free
Dual Network Service	Required	Charged
English guidance	Not required	Free
Multi Number	Required	Charged
2in1	Required	Charged
OFFICEED	Required	Charged
Koe-no-Takuhaibin	Not required	Free
Public mode (Drive mode)	Not required	Free
Public mode (Power OFF)	Not required	Free
Melody Call	Required	Charged



- Network services are not available out of service area or where radio waves are hard to reach.
- For subscription and details of the services, contact "General Inquiries" on the last page of this manual.
- For details, refer to "Mobile Phone User's Guide [Network Services]".
- For details of "OFFICEED", refer to DOCOMO's business website (<http://www.docomo.biz/html/service/officed/>) (In Japanese only).

Setting network service

The operations for major network services are as follows.

Service	Operating procedure
Voice Mail Service	MENU ▶ 7 TEL function ▶ * Voice mail service ▶ Perform the following operation Activate : 1 ▶ "Yes" ▶ "Yes" ▶ Enter ring time Deactivate : 3 ▶ "Yes" Play messages : 5 ▶ 1 or 2 ▶ "Yes" ▶ Follow the guidance to operate
Call Waiting Service	MENU ▶ 7 TEL function ▶ # Other network service ▶ 2 Call waiting ▶ Perform the following operation Activate : 1 ▶ "Yes" Deactivate : 2 ▶ "Yes"
Call Forwarding Service	MENU ▶ 7 TEL function ▶ # Other network service ▶ 1 Call forwarding ▶ Perform the following operation Activate : 1 ▶ "Yes" ▶ "Yes" ▶ Enter a phone number ▶  ▶ "Yes" ▶ Enter ring time Deactivate : 2 ▶ "Yes"

Point

- When ring time is set to "0 sec." for Voice Mail service or Call Forwarding service, incoming calls are not recorded in Received calls.
- To answer a call from another party during a call when call waiting is activated, press . When a party is put on hold, press  to switch the parties to talk to.

Emergency call

You can make the following emergency calls from the FOMA terminal.

Police	110
Fire and ambulance	119
Marine emergencies	118

- This FOMA terminal supports "Emergency Location Report". When making an emergency call to 110, 119, 118, etc., information of your location (location information) is automatically informed to an emergency call receiving organization such as police. The Emergency call acceptance organization may not be able to figure out your exact location depending on the location where you place a call or radio wave condition.

When the caller ID is hidden for the call, i.e., by appending "184" to the dialed number, none of location information or your phone number is notified; however, the organization may acquire the location information and phone number regardless of your settings, if they have determined that such information is necessary for the protection of life etc. The area and timing of implementing "Emergency Location Report" vary by the preparatory state of respective emergency call receiving organizations.

- When calling to 110, 119 or 118 from the FOMA terminal, inform them that you are calling from a mobile phone and give your phone number and your current location precisely since the police or fire department has to call you back for confirmation. To make sure that you are not cut off during the call, do not move during the call and do not turn OFF the phone just after the call, but keep it on for about 10 minutes.
- For some areas you are calling from, you are not connected to the local police or fire department.
- When Auto redial as voice of Operation is set to "ON", videophone call to 110, 119 or 118 from the FOMA terminal changes automatically to voice call.

Using overseas

You can talk with FOMA terminal and use i-mode overseas.

✦ International Roaming (WORLD WING)

International roaming (WORLD WING) is a service that allows you to make voice calls and access i-mode using network of telecommunications carriers affiliated with DOCOMO overseas. Before using this service, check its subscription status. For details, contact "General Inquiries" on the last page of this manual.

- The service is available in areas that 3G Network or GSM/GPRS Network covers. Also, it is available in countries or districts where 3G 850 MHz is applied. Check the service area.
- Refer to the following documents before using FOMA terminal overseas.
 - "Mobile Phone User's Guide [International Services]"
 - DOCOMO International Services website
 - "海外ご利用ガイド" preinstalled in My Document in Data Box (In Japanese only)

Available service overseas

Communication service	3G	GSM/ GPRS	GSM
Voice call	○	○	○
Videophone call	○	×	×
i-mode*1	○	○	×
i-mode mail	○	○	×
SMS*2	○	○	○
i-Channel*1, 3	○	○	×
i-concier*4	○	○	×

Communication service	3G	GSM/ GPRS	GSM
i-Widget*5	○	○	×
GPS*6	○	○	×
Packet communication (PC connection)	○	○	×

- *1 International settings of i-mode are required.
- *2 When you send SMS to FOMA terminal, enter the party's phone number as well as in Japan.
- *3 International settings of i-Channel are required. Packet communication fee is also charged for auto update for Basic channel (included in i-Channel usage fee in Japan).
- *4 International Settings of i-concier is required. Packet communication fee is charged each time you receive information.
- *5 International Settings of i-Widget is required. When multiple Widget Appli communicate, a packet communication fee is charged per one communication.
- *6 No fee is charged for GPS positioning (Position location). However, when displaying a map using location information etc. a packet communication fee is charged.



Making a call from the country you stay

You can make international calls from Japan using International roaming service.

Making an international call



- 1  (1 sec. or more)

"+" is entered.

- 2 Enter "Country code (for Japan, 81)-
phone number without the leading 0 of
Area code (City code)" ▶  (voice
call) or  (videophone call)



In some countries and areas such as Italy, "0"
is required.

Making a call inside the country you stay

- 1 Enter a phone number ▶  (voice
call) or  (videophone call) ▶ "No,
use original"

The call may be made with no message
displayed.

Making a call to WORLD WING user overseas

- 1  (1 sec. or more) ▶ Enter "81 -
mobile phone number without the
leading 0" ▶  (voice call) or  (videophone call)

Point

- The call is forwarded internationally from Japan even when staying in the same country as the party to be called, so enter "+" and the country code of Japan, "81".

- When you enter a number within 2 digits to call overseas, a screen asking for selecting "Quick dial" or "Call" appears. If you select "Quick dial", the call is made to the other party in memory No. of the phonebook. If you select "Call", the call is made as it is (used for emergency overseas).

Receiving a call inside the country you stay

- 1 A call is received ▶  (voice call) or  (videophone call)

Point

- Regardless of the country, from which the call is made, the call is internationally forwarded from Japan. The caller is charged for call fees to Japan, and the receiver is charged for receiving the call.

Setting after returning to Japan

When you turn the FOMA terminal ON, the connection to the FOMA network is established automatically. If it is not automatically connected, set Network search setting to "Auto" and 3G/GSM setting to "Auto".

Sending i-mode mail/Sending SMS

Sending i-mode mail

Only by subscribing to i-mode, i-mode mails can be exchanged not only with i-mode compatible terminals but also via Internet.

- For details of i-mode mail, refer to "Mobile Phone User's Guide [i-mode] FOMA version".

1   [Write]

2 Enter an address, title and text  [Send]

When sending is completed correctly, the mail is automatically saved in a folder of Outbox.

Point

Adding addresses : On the mail creation screen, select "<No address>"

Attachments





You can attach up to 10 files and up to 2 Mbytes of image or moving picture/i-motion, etc. in total.

1 On the mail creation screen, select the attachment field  Select a file type  Attach a file

2 Edit a mail  [Send]

Point





- Sending an attachment file of a big size may take time. After sending such file, a lot of mail in folders of Outbox may be deleted.

Removing attachment : On the mail creation screen, select the attachment field  Move the cursor to the attachment  1 - 3 (for  2, selection is required)  "Yes"

Sending SMS

When you do not know receiver's mail address, you can send a text message to mobile phone number instead of the mail address.

SMS can be also sent to or received from the parties using overseas service providers. For countries and overseas network operators available, refer to "Mobile Phone User's Guide [International Services]" or DOCOMO International Services website.

1   7 Compose new SMS  Enter an address and message  [Send]

Point

- When there is an incoming SMS, FOMA terminal operates in the same way as an incoming i-mode mail. ⇒P50

Deco-mail/Decome-Anime

Deco-mail

You can change a font size or background color, or insert still images, Deco-mail picture or Deco-mail pict.

<Example> Specifying decoration before entering characters

- 1 On the creation screen, "Msg" ▶  [Decorate]

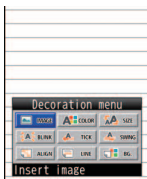

<Decoration menu>

- 2 Select a decoration icon ▶ Decorate
- 3 Edit a mail ▶  [Send]

Point

- When "Auto Deco-mail" is selected after the message text entry, the message is automatically decorated according to the message content. Each time you press , Deco-mail options appear one after another.





Decome-Anime

You can create more expressive Deco-mail using templates made with Flash graphics.



- 1  ▶ 5 Create new Decome-Anime ▶ "Edit"



<Decome-Anime Template list screen>

- 2 Move to the cursor to a template ▶  [OK]
- 3 Edit items
Changing template :  ▶ 1 ▶ "Yes" ▶ Go back to step 2
- 4  [Quit] ▶ Edit a mail ▶  [Send]

Point

- To preview, after loading the template, press  while editing text or images. To return to the previous screen, press .

Receiving i-mode mail

No specific operations or settings are required for receiving mails (mail automatic reception).

1 Receive i-mode mails

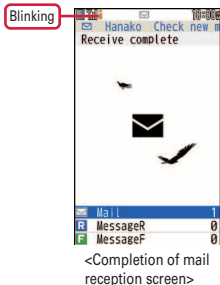

2 On the completion of receiving mail screen, "Mail" ▶ Select a folder ▶ Select a mail

Point

Checking mails in the mailbox : On the stand-by display, [Envelope] ▶ 1 - 3 ▶ Select a folder ▶ Select a mail

Replying to mails

1 [Envelope] ▶ 1 Inbox ▶ Select a folder ▶ Select a mail ▶ [MENU] [Submenu] ▶ 1 Reply/Forward ▶ 1 Reply - 6 Vreply Decome-Anime

2 Edit a mail ▶ [Camera] [Send]

Point

- By selecting a mail and then pressing [Camera], you can reply easily using stored common phrases (Quick reply).

Checking new mail/message

You can make inquiry for any i-mode mail or MessageR/F delivered while you were out of service area or the power was turned OFF.

1 [Envelope] (1 sec. or more)

Point

Checking new SMS : [Envelope] ▶ 9

Setting mail sort rule

Sent/received mails are sorted in folders with rules set.

1 [Envelope] ▶ 1 Inbox or 2 Outbox ▶ Move the cursor to a folder

2 [MENU] [Submenu] ▶ 4 Sort rules ▶ Select a number

3 Select a sort rule ▶ Set a rule

4 [Camera] [Complete]

Point

Re-sorting saved i-mode mail/SMS : [Envelope] ▶ 1 or 2 ▶ [MENU] ▶ 5 ▶ Authenticate ▶ "Yes"

Early warning "Area Mail"

This is a service that you can receive emergency earthquake flash report etc. delivered by the Meteorological Agency. i-mode subscription is not required.

Receiving Area Mail

When an Area Mail is received,  turns on, and you are notified of reception with blinking light, the dedicated buzzer or vibrate alert.

Point

- You cannot receive Area mail during a videophone call or Omakase lock, while using infrared communication/iC transmission.

Receive setting

You can set if you receive Area Mail.

-   **Mail Setting**  **Early warning "Area Mail" setting**  **1 Receive setting**  **1 Yes** or **2 No**

Phonebook new entry

There are two phonebooks: the FOMA terminal phonebook and the UIM phonebook.









<Example> Adding a FOMA terminal phonebook entry

- MENU**  **7 TEL function**  **1 Phonebook**  **2 Add to phonebook**  **Enter a name**  **Set required items**   **[Save]**

Point

Saving to UIM phonebook: **MENU**  **7** **1** **3**  **Enter a name**  **Set required items**  

Adding Phonebook entries from redial/received call

- MENU**  **7 TEL function**  **3 Dialed/Received calls**  **1 Received calls** or **2 Redial**
- Move the cursor to the party**  **MENU**  **[Submenu]**  **4 Add**  **1 Add to phonebook** or **2 Update phonebook**  **1 In phone memory** or **2 In UIM**

To update a phonebook entry, select the entry to add a phone number to.

- Set required items**   **[Save]**









Point

Searching a phonebook entry: **MENU**  **7** **1** **1**  **1** - **7**

Editing a phonebook entry:   **Search the phonebook** 

Move the cursor to a phonebook entry  **MENU**  **3** **1** 

Select an item and edit    "Overwrite" or "New entry"

Deleting a phonebook entry:   **Search the phonebook**  **Move the cursor to a phonebook entry**  **MENU**  **6**  **1** - **3**  **For 2,** select some items, for **3,** authenticate)  "Yes"

Displaying i-mode site/website

With i-mode, you can use services such as site connection, Internet connection or i-mode mail by the display of i-mode compatible terminal. You can use Full Browser or Smart Browser to display websites created for a PC.

- i-mode is a charged service requiring subscription. For details, refer to "Mobile Phone User's Guide [i-mode] FOMA version".
- The contents of sites and Internet websites are generally protected by copyright laws. All or any portion of text, image or other data imported to your i-mode compatible terminal from a site or website cannot be altered except for personal use, and cannot be sold or redistributed in any form without the express permission of the copyright holder.
- If you attach a docomo mini UIM card except yours or turn ON the FOMA terminal without docomo mini UIM card, still images/i-motion/melodies downloaded from websites, attached files sent/received by mail, screen memos and MessageR/F cannot be displayed or played.
- When the stand-by display, ring alert, etc. is set by data with the docomo mini UIM card operation restriction, if you replace the docomo mini UIM card with another one or turn the power ON without docomo mini UIM card, it operates in the default data or standard data.
- i-mode and Full Browser/Smart Browser have different charging systems. It is recommended that you subscribe to i-mode packet flat-rate service because a high packet communication fee is required to use Full Browser/Smart Browser according to data communication volume.

Browsing i-mode website

1 Select an item to view

During i-mode communication,  blinks on the display.

To display English menu, scroll down to the bottom of the iMenu screen and select "English".



<iMENU screen>

Displaying web pages designed for PC

Full Browser

1 2 i-mode/web Full Browser Home

Smart Browser

1 2 i-mode/web Smart Browser Smart Browser

Switching i-mode/Full Browser

1 While site or website is displayed,

Viewing and operating screen

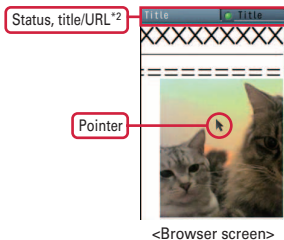

Scrolling up and down*1 : or

Scrolling up and down continuously*1 : (1 sec. or more)

Switching normal/scroll mode*2 :

Changing pages : [← Back]/ [Next →]

Visual history*2/history list*3 : [← Back] (1 sec. or more)/ [Next →] (1 sec. or more)

● In scroll mode*2

Scrolling up or down : [↑ Page]/ [↓ Page]

Scrolling up or down successively : [↑ Page] (1 sec. or more)/ [↓ Page] (1 sec. or more)

• In Full Browser screen, **MENU** ▶ *9, or in Smart Browser screen, **MENU** ▶ 9 ▶ [Operation guide] to display functions assigned to the numeric keys.

*1 When Display Mode in Full Browser is set to PC layout mode or while viewing in Smart Browser, / (1 sec. or more) to scroll right and left/ scroll right and left continuously.

*2 For i-mode/Full Browser

*3 For Smart Browser

Bookmark

You can bookmark frequently visited sites or websites to quickly display them the next time you want to visit.

i-mode/Full Browser

Saving : When a site or website is displayed, **MENU** [Submenu] ▶ 1 2 ▶ "OK" ▶ Select a saving folder

Displaying : **MENU** ▶ 2 2 ▶ Select a folder ▶ Select a bookmark

Smart Browser

Saving : When a website is displayed, **MENU** [Menu] ▶ 1 ▶ "Save page displayed" ▶ [Save]

Displaying : **MENU** ▶ 2 # 2 ▶ Select a folder ▶ Select a bookmark

Screen Memo/Web capture

Currently displayed contents of a site or website can be saved as a screen memo or captured image.

i-mode/Full Browser

Saving : When a site or website is displayed, **MENU** [Submenu] ▶ 2 2 ▶ 1 or 2 ▶ "Yes"

Displaying : **MENU** ▶ 2 3 ▶ 1 or 2 ▶ Select a screen memo

Smart Browser

Saving (images in JPEG format) : When a website is displayed, **MENU** [Menu] ▶ 8 ▶ "Yes"

Using i-Channel



i-Channel is a service that news, weather information, etc. is distributed to the i-Channel compatible terminal. (In Japanese only) The auto-received information appears in the ticker on the stand-by display. Press **[CLR]** to display the channel list.

● Basic Channel

The channel is provided by DOCOMO, and the packet communication fee for automatically updating the distributed information is not charged.

● Okonomi (Optional) channel

The channel is provided by an IP (Information Provider), and the packet communication fee for automatically updating the distributed information is separately charged.

When viewing detail information in Basic Channel or Okonomi Channel, a packet communication fee is separately charged. For overseas use, packet communication fee is charged for both automatic update and viewing detail information.

- i-Channel is a charged service requiring subscription. i-mode subscription is required for the service.
- For details, refer to "Mobile Phone User's Guide [i-mode] FOMA version".



To view the detail information of the ticker displayed, perform the following operation.

1 On the stand-by display, **[CLR]** ▶ **Select a channel**

The site is connected and the detail information appears.

Point

- When the detail information of i-Channel is displayed, the same operations as the ones when i-mode sites or websites are available. ⇒P53

Using Map/GPS function

- This function is unavailable as a navigation device for aircraft, vehicles or persons or as high-precision location surveying GPS. DOCOMO is not liable to any purely economic damages including troubles, if any, caused by missing opportunities of viewing positioning results or making communications due to failures or malfunctions of the FOMA terminal or external events such as defect, power interruption (including battery exhaustion) in using the FOMA terminal for purposes including but not limited to the above.
- Because GPS is managed by U.S. Department of Defense, GPS wave conditions may be controlled (accuracy degraded or wave stopped) for security reasons of the U.S. And, wave conditions differ by satellite locations; therefore, positioning operations in the same location under the same environmental conditions may not yield the same result.
- Because GPS uses waves transmitted from satellites, under the circumstances that waves cannot be received or become hard to be received, there may be a margin of error of 300 m or more in location information.
- When using Location request and Notify location functions, check instructions and precautions given in website of GPS service providers and NTT DOCOMO. And, you may be charged for using these functions.
- The GPS function except Position location is unavailable out of service area.

Map/Navigation

You can start GPS compatible i-appli to display maps after positioning location or navigate.

- 1 **MENU** ▶ 9 **Map/Overseas** ▶ 1 **Map or**
2 **Navigation**

Point

- i-appli set in Select map in Map setting starts. "地図アプリ (Map Application)" is set by default.

Position location

You can check where you are. No packet communication fee applies for positioning of Position location, but a packet communication fee is required separately with map displayed using location information.

- 1 **MENU** ▶ 9 **Map/**
Overseas ▶ 6

Position location/ Location notification ▶ 1 **Position** **location**

When positioning is in progress,  blinks.

When positioning is completed, the position location menu appears.

From the menu, you can select options to read map, use GPS compatible i-appli, display the mail creation screen on which location information is pasted, add to phonebook, etc.

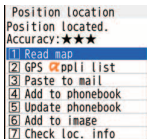

<Location information usage menu>

- Your current location or information measured by Pedometer/Activity monitor is automatically sent to service providers on a regular basis (approximately once in every 5 minutes), which allows you to services that deliver information about the weather or shops around where you are, or sightseeing information. (In Japanese only)
- To use an AUTO-GPS compatible service, set AUTO-GPS service information from its AUTO-GPS compatible i-appli.
- When using the AUTO-GPS function, check instructions and precautions given in website of GPS service providers and NTT DOCOMO. And, you may be charged for using these services.
- Note that more power is consumed in FOMA terminal due to a regular communication depending on your usage condition.
- You can set "Low battery setting" to deactivate the AUTO-GPS function to save the battery consumption when the battery level gets low.

Setting AUTO-GPS

Set whether to use the AUTO-GPS function.

- MENU** ▶ **9** **Map/Overseas** ▶ **7**
Map&GPS setting/history ▶ **5** **AUTO-GPS** ▶ **2** **AUTO-GPS setting** ▶ **1** **ON** or **2** **OFF**

Setting services provided by DOCOMO

To use AUTO-GPS services that work with i-concier or services provided by DOCOMO, set whether to send your location information to DOCOMO on a regular basis. These services require separate subscriptions to use.

- MENU** ▶ **9** **Map/Overseas** ▶ **7**
Map&GPS setting/history ▶ **5** **AUTO-GPS** ▶ **1** **DOCOMO service set** ▶ **"ON"** or **"OFF"**

Setup service list

Display a list of the names of i-appli (the service name), to which AUTO-GPS service information is set, and its status.

- MENU** ▶ **9** **Map/Overseas** ▶ **7**
Map&GPS setting/history ▶ **5** **AUTO-GPS** ▶ **3** **Setup service list**
Canceling the service (including AUTO-GPS) :
 While a setting services list is displayed, **MENU** ▶ **1** ▶ **1** - **3** (▶ For **2**, select an item, for **3**, authenticate) ▶ **"Yes"**

Shooting still images/moving pictures

Viewing shooting screen

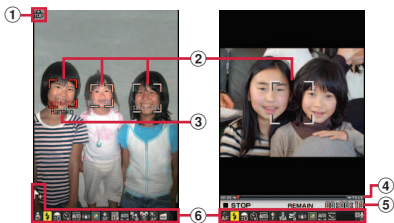

<Still image shooting screen> <Moving picture shooting screen>

- 1 **Sense orientation icon**
- 2 **Focus frame, face detection frame**
- 3 **Name of detected person (Find-me focus)**
- 4 **Zoom rate**
- 5 **Available remaining time estimate**
- 6 **Setting icons**

- Attach location
- Auto-focus
- Night mode/Light
- Brightness Auto timer
- Shoot by scene Fix camera shake
- Continuous mode Auto/Panorama shooting number
- Art camera Image quality
- Size Snap movie
- White balance
- Best-shot select
- Panorama Fast-Mo
- Smile-finder
- Tracking focus Skew correction

Shooting type (Switch img/voice)

Shooting still images

- 1
- 2 **Point the camera at an object,** []

OR

When Auto save mode is "OFF", a confirmation screen for saving appears.

Shooting moving pictures

- 1
- 2 **Point the camera at an object,** [Rec/Record] OR
- 3 **To stop shooting,** [Stop] OR 1 **Save**

Point

- If FOMA terminal is left in a warm place or exposed to direct sunlight for a long time, images to be shot may be deteriorated.
- If the FOMA terminal is closed or no key operations are performed for approximately 2 minutes during shooting stand-by, the camera ends.
- Note that your hand may cover the light depending on how you hold the terminal.
- If the inside temperature of the FOMA terminal becomes high because of heat during camera operation, the recording or camera function may be deactivated before the maximum recording time to protect the FOMA terminal. In this case, wait until the temperature of the FOMA terminal drops and use the camera function. This is normal.

Viewing still images/moving pictures

Still images/moving pictures are saved to Data Box.

1 [MENU] ▶ **5** Data Box ▶ For still image, **1**

My picture or for moving picture,
4 i-motion/Movie ▶ Select a folder ▶
 Select data

Shooting in various methods

To do	Operation
Switch camera-mode	On the shooting screen, [MENU] [Setting] ▶ 5 ▶ Select an item
Smile-finder	On the still image shooting screen, [MENU] [Setting] ▶ * ▶ Select an item ▶ [MENU] [Close]
Best-shot select	On the still image shooting screen, [MENU] [Setting] ▶ 6 2 ▶ [MENU] [Close] ▶ Point the camera at an object, or ▶ Operate Save all, Save one image, etc.
Continuous mode Auto	On the still image shooting screen, [MENU] [Setting] ▶ 6 3 ▶ [MENU] [Close] ▶ Point the camera at an object, or
Panorama shooting	On the still image shooting screen, [MENU] [Setting] ▶ 6 4 ▶ [MENU] [Close] ▶ Point the camera at an object, [or ▶ Overlapping transparent parts, repeat [or until maximum shooting number is reached

To do	Operation
Art camera	On the shooting screen, [Effect] ▶ 3 ▶ Select an item ▶ [MENU] [Close] ▶ Adjust with
Snap movie	On the moving picture shooting screen, [MENU] [Setting] ▶ 6 2 ▶ [MENU] [Close]
Fast-Mo	On the moving picture shooting screen, [Effect] ▶ 4 ▶ Select an item ▶ [MENU] [Close]

The following operations are available on the shooting screen.

Displaying Data Box : [List]

Turning on/off camera light : [Light]

- Available only for IN camera.

Night mode On/Off : [Night]

- Available only for OUT camera.

Brightness :

Zooming in/out :

Focus lock :

Keypad guide display :

Graffiti picture

Decorate a still image with the included touch pen. Shoot and decorate from the dedicated screen or decorate saved still image.

Touch panel

- Use the included touch pen to operate the touch panel.
- Touching the touch panel may not work in the following cases. Note that it may cause malfunction.
 - Operation with a foreign object on the touch panel
 - Operation with protective sheet or seal on the touch panel
 - Operation on the wet touch panel
 - Operation with the touch pen wet with water etc.
 - Operation under water
- Do not push the touch panel forcibly with a sharp object such as nail, ballpoint pen, pin, or the finger.
- Do not press forcibly the frame part around the display. The touch panel may malfunction.

Basic operation on the touch panel

Tap : Press the display lightly once and release the touch pen.

Drag : Press the display lightly and move the touch pen without lifting.

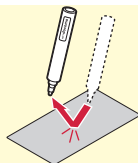

Example : Tap

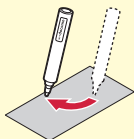

Example : Drag

Creating Graffiti picture

The procedure to shoot a picture and create Graffiti picture is explained.

- 1** **MENU** ▶ **4 CAMERA/TV/MUSIC** ▶ **1**

Camera ▶ **2 Graffiti picture** ▶ **Tap [はじめから (from the picture shooting)]**

To create a Graffiti picture from a saved picture, tap [らくがきから (Decorate)].

- 2** **Follow the on-screen instruction to tap an item** ▶ **Tap [撮影スタート (Start shooting)]** or **[●]** or **[📷]**

Countdown starts and a picture is shot in approximately 3 seconds.

- 3** **Check the shot picture** ▶ **Tap [らくがき開始 (Start Graffiti picture)]** or **[●]** or **[📷]** ▶ **Edit a still picture**

You can draw image or paste stamps on the edit screen with the included touch pen.

- 4** **Tap [完成 (Done)]** ▶ **Select saving location** ▶ **Perform the operation you want**

Watching 1Seg

● Using 1Seg

1Seg is a service provided by TV broadcasting enterprises (stations), etc. A communication fee for receiving video picture and sound is not required. Contact NHK for details on your NHK viewing fees.

- * For viewing "Data broadcasting site", "i-mode site", etc., packet communication fees are charged. Some sites require information fees (i-mode pay sites).
- * For details of "1Seg" service, refer to the following websites.

The Association for Promotion of Digital Broadcasting

From a PC : <http://www.dpa.or.jp/>

From i-mode : <http://www.dpa.or.jp/1seg/k/> (In Japanese only)

● Airwaves

1Seg is one of the broadcast services and a different type of radio waves (airwaves) from that of FOMA service is received. In the following cases, reception condition may become bad or reception may be unavailable.

- A place far from the tower that the airwaves are sent from
 - Mountain-ringed regions or a place between buildings
 - Tunnel, underground or far back from a building
- * To receive stronger radio waves, try moving the FOMA terminal away from or close to the body or moving to another location.

<Cautions on the termination of analog broadcasting>

In some regions channels are rearranged with the termination of analog broadcasting. Therefore, you may be required to reset "Auto setting" by auto scanning. And, after you reset channels by "Auto setting", make sure to register them to the channel list. For details on rearrangement of Digital Terrestrial Television Broadcasting, refer to the following websites.

総務省テレビ受信者支援センター (デジサポ)
(DTV Support Center, Ministry of Internal Affairs and Communications) チャンネル変更コールセンター (Channel change call center)

Phone number : 0120-922-303

From a PC : <http://www.digisuppo.jp/index.php/repack/> (In Japanese only)

From i-mode : <http://digisuppo.jp/m/index.php> (In Japanese only)

● Screen appearing when using 1Seg for the first time

A disclaimer confirmation screen appears. If you agree and then press "OK", the confirmation screen does not appear again.

Creating a channel list (for the first-time creation)

To watch 1Seg, you need to create a channel list.

<Example> Searching for broadcasting stations and channels that can be received in your current location (Auto setting).

1 [MENU] ▶ 4 CAMERA/TV/MUSIC ▶ 2
1Seg ▶ 7 Channel setting ▶ "Yes" ▶
"Auto setting" ▶ "Yes"

For "Auto setting", perform the operation in the digital terrestrial broadcasting service area.

Select "Use preset" to load broadcasting stations and channels that are pre-registered to the FOMA terminal.

2 Select an area ▶ "Yes"

Watching 1Seg

1 (1 sec. or more)



Viewing and operating the watching screen

You can watch 1Seg in full screen, or divide the screen to watch the data broadcasting.









<Horizontal display (full screen)>

When Switch active operations in Image & Effect is "OFF", the following operations are available.

Adjusting volume :  [Low]/  [High] or 

Starting Program guide i-αppli :  [EPG]

Selecting a channel :  - , , , 

Selecting the previous and next channel : 

Recording still images : 

Starting/Stopping a video recording :  (1 sec. or more)

Switching the watching screen : 

Showing/Hiding Subtitle :  (1 sec. or more)

Point

- You can make settings for timer watching/recording, Time out, Smooth image, 1Seg eco mode, etc.

Displaying key function help : While watching,

 ▶ 

Watching/Recording reservation

1  ▶  CAMERA/TV/MUSIC ▶ 
1Seg ▶  TV timer list

2  [Submenu] ▶  Set new timer ▶
Select timer option ▶  [Save]

When selecting "Manual reception" or "Manual recording", you proceed to set the reservation details such as time and date or channel. Selecting "By program guide" activates program guide i-αppli. When you reserve watching or recording a program by selecting it in the program guide i-αppli, the reservation information is saved and displayed on the setting screen.

3  [Save]

Point

- If "Record to:" in "Record setting" is set to "Auto (phone first)" or "Auto (microSD first)" on the recording reservation screen, the saving location switches automatically according to free space or savable number.

Playing a recorded program

1  ▶  Data Box ▶  1Seg ▶ Select a folder ▶ Select data

Music&Video Channel

Music&Video Channel is a service which automatically distributes a program of up to approximately 2 hours at night. You can also enjoy high-quality video program of up to approximately 1 hour. (In Japanese only)

- Music&Video Channel is a charged service requiring subscription. Subscriptions to i-mode and i-mode packet flat-rate services are required for the service.
- Information fee may be required additionally for some programs besides Music&Video Channel service fee.
- If docomo mini UIM card is used on a Music&Video Channel incompatible FOMA terminal after subscribing to Music&Video Channel, Music&Video Channel cannot be used. Note that the service fee is charged unless Music&Video Channel is unsubscribed.
- Program setting and downloading are unavailable during international roaming*. Stop distribution of programs before leaving Japan. When you return to Japan, resume distribution of programs.
- * Note that attempting program setting or downloading during international roaming requires packet communication fee for i-mode connection.
- For details, refer to "Mobile Phone User's Guide [i-mode] FOMA version".

Program setting

To set programs, registering Music&Video Channel program site in My Menu may be required.

- 1 **MENU** ▶ **4 CAMERA/TV/MUSIC** ▶ **4 Music&Video Channel**
- 2 **"Program setting"** ▶ **Set a program according to instructions on the screen**

Playing a program

- 1 **MENU** ▶ **4 CAMERA/TV/MUSIC** ▶ **4 Music&Video Channel** ▶ **Select a program**
- The following operations are available on the player screen.
- Pausing/Playing** : **[PAUSE/PLAY]** or **[]**
- Adjusting volume** : **[]** or **[]**
- Rewinding/Fast forwarding** : **[]** (1 sec. or more)
- Jumping to the beginning of chapter** : 2 seconds or more in play time, **[]** or **[]** (1 sec. or more)
- Jumping to the previous chapter** : Less than 2 seconds in play time, **[]** or **[]** (1 sec. or more)
- Jumping to the next chapter** : **[]** or **[]** (1 sec. or more)

MUSIC Player

You can play Chaku-uta full downloaded from a site and Windows Media® Audio (WMA) files imported from music CDs, the Internet, etc. to a PC. And Uta-moji lyrics downloaded from a site can be displayed on the player screen by setting Link lyrics & song.

* For details of MUSIC Player, refer to NTT DOCOMO website. For Windows Media Player, contact the manufacturer of your PC.

Downloading Chaku-uta full

- 1 **Display a site ▶ Select Chaku-uta full ▶ "Save" ▶ "Phone" or "microSD"**

Saving WMA file on a PC to microSD card

For connection to a PC, FOMA USB Cable (optional) is required.

- 1 **[MENU] ▶ [8] Setting ▶ [8] External connection ▶ [1] USB mode ▶ [3] MTP mode ▶ "Yes"**
- 2 **With Windows Media Player activated, connect FOMA terminal to a PC using USB cable ▶ Send WMA file from the PC**

Playing music data

- 1 **[MENU] ▶ [4] CAMERA/TV/MUSIC ▶ [3]**

MUSIC Player ▶ Select a folder or playlist ▶ Select music data

The following operations are available on the player screen.

Pausing/Playing : [PAUSE/PLAY] or

Adjusting volume : or

Rewinding/Fast forwarding : (1 sec. or more)

Jumping to the beginning of track : 2 seconds or more in play time, or (1 sec. or more)

Jumping to the previous track : Less than 2 seconds in play time, or (1 sec. or more)

Jumping to the next track : or (1 sec. or more)

Adding to Quick playlist : Press twice quickly

End : (1 sec. or more)

Point

- When downloading music data from Internet websites etc., check the use conditions.
- Music data saved in FOMA terminal or microSD card is allowed for personal use only. When using the music data, take extreme care not to infringe intellectual property rights of a third party such as copyrights etc.

● ● ●

i-αappli is a software for i-mode compatible terminals, which updates the information of stock price or weather automatically, or provides games that can be played without connecting to the network. i-Widget is a convenient function that allows you to easily access frequently-used contents and tools (Widget Appli) such as calculator, clock, memo, stock price information, etc.

Either i-αappli or i-Widget can be downloaded from i-mode site or sites provided by IPs (Information Providers). For details, refer to "Mobile Phone User's Guide [i-mode] FOMA version".

- A packet communication fee may be separately required.
- When downloading or displaying i-Widget screen, etc. a packet communication fee may be separately charged.
- When i-Widget screen is displayed, multiple Widget Appli may communicate.
- A packet communication fee for overseas use differs from the one in Japan.
- DOCOMO assumes no responsibility for the information set in Osaifu-Keitai compatible i-αappli (IC card).
- If you delete stored i-αappli, you can download the software from "@Fケータイ応援団 (@Fケータイ応援団 (@F mobile phone supporters))" site.
"@Fケータイ応援団 (@F mobile phone supporters)"
(as of November, 2011)



QR code for
site access

iMenu ⇒ メニューリスト (Menu list) ⇒ ケータイ
電話メーカー (Mobile phone manufacturer) ⇒
@Fケータイ応援団 (@F mobile phone
supporters) (In Japanese only)

- * The access method may be changed without previous notice.

Downloading

- 1 **Display a site ▶ Select i-αappli ▶ After completion of downloading, "Yes" or "No"**

Downloaded i-αappli is saved to "My folder" of Software list. When Message i-αappli is downloaded, the folders for Message i-αappli are automatically created in the folder list.

Starting i-αappli

- 1 **☑ (1 sec. or more) ▶ Select a folder ▶ Select i-αappli**

Point

Starting Osaifu-Keitai compatible i-αappli : **[MENU] ▶**

#1 ▶ Select i-αappli

Starting GPS compatible i-αappli : **[MENU] ▶ 9 5 ▶**

Select i-αappli

Starting i-Widget

- 1 **☑▶ Select Widget Appli**

Playing i-motion/movie

You can obtain i-motion/movie (images, sound, etc) from sites or websites.

❖ Playable i-motion

Type	Playing action
Standard type (can be saved*)	While the i-motion data is downloaded, it is played. • The downloaded i-motion can be operated in the same way as the i-motion which is played after entire data is downloaded. After the entire i-motion data is downloaded, it is played.
Streaming type (cannot be saved)	While the i-motion data is downloaded, it is played. • After the i-motion data is played, it is deleted.

* Some i-motion cannot be saved.

❖ Playable movies

Type	Distribution method	Playing action
Streaming type (cannot be saved)	Real-time distribution	The movie is distributed in real time. • Pausing/Resuming play/Moving play position are unavailable.
	On-demand distribution	Distribute movies that are prepared in advance.





Downloading i-motion/Movie

- Select i-motion/Movie while site or website is displayed**
Playback starts while data is downloaded or when the download is completed.
- "Save" ▶ Move the cursor to a folder to save**  [OK]
For streaming type i-motion, select "Back" to return to the site screen.

Point

- Note that communication of a large amount of data, such as downloading a movie, requires high packet communication charges.

Playing moving picture/i-motion

- MENU** ▶ **5 Data Box** ▶ **4 i-motion/Movie** ▶ **Select a folder** ▶ **Select a moving picture/i-motion**
The following operations are available during playback.
Adjusting volume :  or 
Rewinding/Fast forwarding :  (1 sec. or more)
Pausing/Playing/Playing from the beginning (while stopping) : 
Stopping : 

Using Osaifu-Keitai

■ Osaifu-Keitai

Osaifu-Keitai is equipped with IC card and allows you to pay money or to use coupon or stamp rally only by holding FOMA terminal over the IC card reader in stores etc.

And you can access site or web site by holding the FOMA terminal over IC card reader, obtain the latest coupon by using communication, credit electronic money, or check the usage. Various security systems are also equipped. For details, refer to "Mobile Phone User's Guide [i-mode] FOMA version".

- The data (including electronic money, points, etc.) in the IC card may be lost or modified because of the malfunction of FOMA terminal (When we take your Osaifu-Keitai for repair etc., as we cannot take it with data remained, you are required to erase the data by yourself). For support such as reissuance, restoration, temporary preservation or transfer of data except transfer by iC transfer service, confirm with Osaifu-Keitai compatible service provider. For important data, be sure to use an Osaifu-Keitai compatible service with backup service.
- If the data in the IC card is lost, modified or damaged by any means related to Osaifu-Keitai compatible service such as malfunction or model change, DOCOMO assumes no responsibility for the loss of data.
- If FOMA terminal is stolen or misplaced, immediately contact Osaifu-Keitai compatible service provider for an advice.

■ ToruCa

ToruCa is an electronic card that can be obtained from the FOMA terminal. It can conveniently be used as leaflet, restaurant card, coupon ticket, etc. You can obtain ToruCa from an IC card reader, a site, or data broadcasting. It can be exchanged via mail, infrared communication, or iC communication. For details, refer to "Mobile Phone User's Guide [i-mode] FOMA version".

Steps for using Osaifu-Keitai

You can start Osaifu-Keitai compatible i-appli to credit money or check the balance or usage. You can use the Osaifu-Keitai services compatible with Osaifu-Keitai Web plug-in from a site.

- 1 Download Osaifu-Keitai compatible i-appli as necessary**
- 2 Make the initial settings of the Osaifu-Keitai compatible service**
- 3 Hold  mark of the FOMA terminal over IC card reader**
At this time, starting Osaifu-Keitai compatible i-appli is not required.

Point

- If IC card is not detected successfully when you hold  mark of the FOMA terminal over IC card reader, try moving the FOMA terminal back, forth and around.
- You can disable IC card functions using "IC card lock". ⇒P38

Using i-concier

i-concier is a service that Machi-chara (a character on the stand-by display) supports your life like a butler or concierge. It stores your information about area of residence, memos, schedule, ToruCa, phonebook, etc. and offers you information that suits content of memos or schedules, your living area, preferences, and interest at the right time. It can offer information related to memos, schedules and ToDo saved in the FOMA terminal, automatically update schedules and ToruCa, etc., and automatically add useful information such as shop hours to the phonebook. (In Japanese only) The stored schedules or images can be shared with group of your friends, family, etc. You can print the stored images easily.

- i-concier is a charged service requiring subscription (Subscription is required subscription of i-mode).
- If you do not subscribe Data Security Service, when you subscribe i-concier, you subscribe Data Security Service, too.
- A packet communication fee is separately required to receive information except for some information.
- A packet communication fee is separately required to use detail information.
- To use i-concier overseas, International service settings require to be set. For using international roaming services, a packet communication fee is charged for both receiving and viewing detail information (it differs from the charge in Japan).
- Information fee may be additionally required for some contents besides i-concier monthly service fee.

- Automatic updating i-schedule/memo/ToruCa/ phonebook, etc. requires a packet communication fee separately.
- For details, refer to "Mobile Phone User's Guide [i-mode] FOMA version".

Receiving information

Information is sent automatically.

1 Information is received

- 1  Lights on in the status area with light or ring alert for notification.



"くーまん (Kuman)"
©Dora communications

<Information reception screen>

- 2 **On the stand-by display, select a popup message ▶ Select a piece of information**
Some pieces of information may have a memo of schedule or ToruCa attached or contain a link to a site. To display details, select the icon.

Point

Displaying detail of received information on the stand-by display : [MENU] ▶  ▶ "インフォメーション一覧 (Information list)" ▶ Select a piece of information

Shabette-Kensaku

You can use i-mode search by speaking a keyword.

1  (1 sec. or more)

For the first activation, check the guidance screen and select "Use (default)" or "Use".

2 **After the terminal vibrates, speak search keyword in Japanese within 10 seconds** ▶  [Fix]

The i-mode site is connected and search results appear.

Point

- Speak clearly with natural conversation speed.
- Depending on the environment or way of speaking, recognition result may vary.

Voice quick start

When you do not know a desired menu of function or you want to activate the function quickly, the function can be activated by voice sound input from the stand-by display. (In Japanese only)

1  (1 sec. or more)

For the first activation, on the guidance screen, select "利用する (Use)" or press .

2 **When "それではどうぞ ★★音声受付中 ★★ (Please speak★★waiting for your voice★★)" appears, speak a function name toward the microphone within 10 seconds.**

When a message "もう一度お話しください (Speak again)" appears, press  and speak again.

When the voice input is recognized, the function activates. If the function is not identified, the keyword list of 使いかたガイド (Guide) appears.

Point

- Speak clearly with natural conversation speed.
 - Depending on the environment or way of speaking, recognition result may vary.
 - You can speak function name (電卓 (Calculator), ワンセグ (1Seg), etc.), keyword (計算 (calculation), テレビ (TV), アドレス交換 (address exchange), etc.) or combination of keywords (写真 見る (view photo), メール 問い合わせ (mail check), ○○さん*にメール (mail to Mr. ○○), etc.) to activate the function.
- * Name registered to the phonebook

Schedule

Manage memos by Schedule or check a downloaded i-schedule. (In Japanese only)
The view and function of schedule varies by the schedule type. "Normal" in which you can manage the schedules linking with i-concier or the memo list is described here.

Registering note from the schedule

1 [MENU] ▶ 6 Tool ▶ 5 Schedule ▶ [MENU]
[Submenu] ▶ 1 New entry

2 Set required items ▶ [Save]
Showing/Hiding hint : [Hint ON/OFF]

You can select entry options from the hint displayed in "シール (Seal)", "いつ? (When?)", "どこで? (Where?)", "だれと? (With whom?)", "共有設定 (Share setting)", "添付 (Attachment)" field.

Point

Saving quickly from the stand-by display (Quick schedule) : On the stand-by display, enter the date and time to save a schedule (for 10:00 on November 25, enter "11251000") ▶

Checking a schedule

1 [MENU] ▶ 6 Tool ▶ 5 Schedule ▶ Select date ▶ Select a memo

Alarm

You can also set to activate 1Seg after sounding alarm.

1 [MENU] ▶ 6 Tool ▶ 3 Alarm ▶ Select a number ▶ to switch the screen to set required items ▶ [Set]

Point

- In "Snooze (Snz)", set the sound intervals for 30 minutes.
- Alarm stops or starts snooze if no operations are made for approximately 1 minute, pressing a key other than , and , double-tapping the FOMA terminal.

Convenient tools

Bar code reader

You can read and use information of JAN code, QR code, NW7 code, and CODE39 code.

1 ▶ 6 ▶ 1 ▶

Move the OUT camera over a bar code

When scanning is completed, a confirmation sound is heard and the scanned data appears.

Point

- When a bar code is hard to read, press to switch to the shutter mode, or adjust the distance between the code and camera, angle, or direction.

Convenient tools

Personal alarm

Personal alarm sounds at full volume for emergency. With a loud alarm, making a voice call automatically and notifying your location using GPS function are available.

To use personal alarm, set Kid-safe mode "ON" and make required settings for Set personal alarm.

Changing personal alarm settings

1 ▶ 8 ▶ 6 ▶

5 ▶ ▶

1 ▶ 1 ▶

When Kid-safe mode is set to "ON", appears on the display.

2 ▶ ▶ ▶

Turn "ON" Set personal alarm to use personal alarm. If Link personal alarm is set to "Alarm+Voice call", a voice call is made to the party registered in the emergency contact when a personal alarm sounds.

3 [Set]

appears on the display.

Activating personal alarm

1 (1 sec. or more) with FOMA terminal closed

Point

- The volume of the personal alarm cannot be changed. Since the alarm sounds at full volume, be aware when using.

Using microSD card

You can save still images, moving pictures, melodies, etc. or backup data of phonebook, schedule, etc. in microSD card.

- The F-06D supports commercially available microSD card of up to 2 GB, and microSDHC card of up to 32 GB (As of November, 2011). For the latest information on the operation check, see the followings. Note that the information shown is the result of the operation check and actual operations are not guaranteed for all microSD/SDHC cards. For microSD cards not mentioned in the manual, contact each microSD manufacturer.

From i-mode : iMenu ⇒ メニューリスト (Menu list) ⇒ ケータイ電話メーカー (Mobile phone manufacturer) ⇒ @Fケータイ応援団 (@F mobile phone supporters) ⇒ メモリーカード対応情報 (Memory card support information) (In Japanese only)



QR code for site access

From PC : FMWORLD (<http://www.fmworld.net/>) ⇒ 携帯電話の製品情報 (Product information of mobile phones) ⇒ microSD対応状況、microSDHC対応状況 (microSD/microSDHC support information) (In Japanese only)

- * The access method may be changed without previous notice.

✚ Precautions on using microSD card

- The data saved from another device such as a PC may not be displayed or played in FOMA terminal. And the data saved from FOMA terminal may not be displayed or played in other device.

Installing

- 1 Turn FOMA terminal OFF and remove the battery pack
- 2 Insert the microSD card slowly into the slot with metal contacts side down (as shown below), and insert it further until it clicks

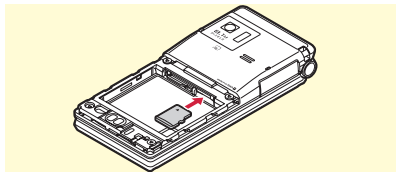

- * To remove the microSD card, push it lightly to pop it out, and then pull it out.

Formatting

Format microSD card with FOMA terminal before using.

- 1 [MENU] ▶ [6] Tool ▶ [*] microSD ▶ [📷]
[Format] ▶ Authenticate ▶ "Yes"

Point

- Formatting microSD card deletes the data in the card.

Exchanging data between the FOMA terminal and microSD card

Copying images to microSD card

- 1 **[MENU]** ▶ **5 Data Box** ▶ **1 My picture** ▶
Select a folder ▶ **Move the cursor to data**

When the folder list of microSD card, select "→ phone".

- 2 **[MENU]** **[Submenu]** ▶ **5 Move/Copy** ▶
3 Copy to microSD ▶ **Select copying method**

Select image to copy selected item ▶ , authenticate to copy all data in a folder.

- 3 **"Yes"**
Move the cursor to a folder to copy an item ▶
Press .

Point

- If you select "[2] Move → microSD" in Step 2, you can move data to the microSD card.
- You cannot move or copy the data that is inhibited to output from FOMA terminal.

Copying images to the FOMA terminal

- 1 **[MENU]** ▶ **6 Tool** ▶ *** microSD** ▶ **1 Data box** ▶ **1 My Picture** ▶ **Select a folder** ▶
Move the cursor to data

- 2 **[MENU]** **[Submenu]** ▶ **5 Move/Copy** ▶
3 Copy to the phone ▶ **Select copying method**

Select image to copy selected item ▶ , authenticate to copy all data in a folder.

- 3 **Move to the cursor to a folder** ▶ 
[Confirm] ▶ **"Yes"**

When copying one item, omit pressing "Yes".

Point

- If you select "[2] Move to phone" in Step 2, you can move data to the FOMA terminal.

Backing up at once

You can back up phonebook entries, notes, mails, bookmarks, set item data all at once in the microSD card. Data is overwritten for the second-time backup or later.

- 1 **[MENU]** ▶ **6 Tool** ▶ *** microSD** ▶ **7**
Backup/Restore ▶ **1 Backup to microSD**

- 2 **Authenticate** ▶ **"Yes"**
When phonebook is not saved, omit Step 3.

- 3 **"Yes" or "No"**

Point

- Some restrictions apply, such as moving pictures saved in phonebook or the part of the attachment files in excess of 100 Kbytes are not backed up.
- Select "[2] Restore to phone" at the end of Step 1 to overwrite data in the FOMA terminal with data collectively backed up in the microSD card.

Infrared communication/iC transmission

You can send/receive data to/from devices such as FOMA terminal supporting infrared communication function or iC transmission function.

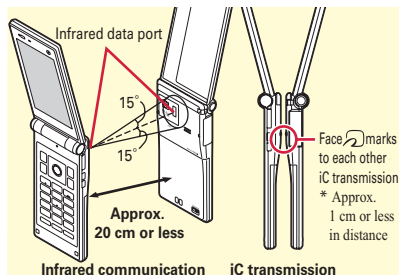
**Point**

- When sending/receiving all data items, the sender and receiver need to determine a 4-digit authentication password in advance. For infrared communication, the receiver's terminal must be ready for communication first.
- When sending/receiving all data items, the data saved in the receiver (included phonebook entries, notes, protected mail with secret attribute) is deleted, and the newly received data is saved. However, for some receiving terminals, when sending all infrared data, image, moving picture, melody, document (PDF data) and Decome-Template are added. Folder names or order of data may differ from the ones of sender.
- While charging, sending data by iC transmission is unavailable.

To do	Operation
Sending an item via infrared communication/iC transmission <Example> Phonebook entry	Move the cursor to a phonebook entry ► MENU [Submenu] ► 8 ► 1 or 2 ► 1 ► "Yes"
Sending all items via infrared communication/iC transmission	MENU ► 6 4 ► 2 or 3 ► Select an item to send ► Authenticate ► Enter an authentication password ► "Yes"
Receiving an item via infrared communication	MENU ► 6 4 1 1 ► "Yes" ► Send data from a sender ► After receiving, "Yes"
Receiving an item via iC transmission	With the stand-by display on a receiver, place marks close to each other ► Send data from a sender ► After receiving, "Yes"
Receiving all items via infrared communication	MENU ► 6 4 1 2 ► Authenticate ► Enter an authentication password ► "Yes" ► Send data from a sender ► "Yes"
Receiving all items via iC transmission	With the stand-by display on a receiver, place marks close to each other ► Send data from a sender ► Authenticate ► Enter an authentication password ► Place the marks close to each other ► "Yes"

Connecting to a PC

You can connect FOMA terminal to a PC to transfer WMA files or images in the microSD card. Also, connecting to the Internet for data communication is available.

- FOMA USB Cable with Charge Function 02 (optional) or FOMA USB Cable (optional) is required.
- To perform data transfer using data communication or DOCOMO keitai datalink, install FOMA communication configuration (driver) on a PC. For details, refer to "Manual for PC Connection".
"FOMA communication configuration file" and "Manual for PC Connection" can be downloaded from NTT DOCOMO website.
<http://www.nttdocomo.co.jp/support/>

USB mode

From a PC, you can operate data in a microSD card in FOMA terminal.

- When USB mode is set to "microSD mode" or "MTP mode", installation of FOMA communication configuration file (driver) is not necessary.

1 **[MENU]** ▶ **[8]** **Setting** ▶ **[8]** **External connection** ▶ **[1]** **USB mode** ▶ **Select a mode**

Communication mode : Set for packet communication, 64K data communication or data transfer by connecting to a PC.

microSD mode : Set for recognizing the microSD card in FOMA terminal as a drive and operating the data by PC operation.

MTP mode : Set for music data transfer to microSD card using Windows Media Player.

2 **"Yes"**

DOCOMO Connection Manager

DOCOMO Connection Manager is convenient software to use DOCOMO's data communication. You can easily make a PC setting according to your subscription status and check an estimate of data communication volume or usage fees by the charge counter function. For details, refer to NTT DOCOMO website.

http://www.nttdocomo.co.jp/support/utilization/application/service/connection_manager/

DOCOMO keitai datalink

DOCOMO keitai datalink is a software for backing up phonebook, mail and other data in your mobile phone to a PC and editing them. It can be downloaded from NTT DOCOMO website. For details and downloading, refer to the following website.

<http://datalink.nttdocomo.co.jp/> (In Japanese only)

For details including downloading procedures, data that can be transferred, operating environments, installing procedures and operations, refer to the website above. For operations after installation, see Help in the software.

Check for the necessity of software update first, and update the software if necessary. ⇒P79

When checking the following items not to improve the state, contact "Repairs" on the last page of this manual (in Japanese only) or DOCOMO-specified repair office.

❖ Power supply and charging

● FOMA terminal cannot be turned ON.

- Is the battery pack installed correctly?
- Is the battery exhausted?

● The FOMA terminal cannot be charged (the light does not turn on while charging).

- Is the battery pack installed correctly?
- Are the adapter and FOMA terminal set correctly?
- Is the AC adapter connector securely inserted to FOMA terminal or the desktop holder that came with the terminal when you use AC adapter (optional)?
- Is AC adapters power plug or cigarette lighter plug inserted to the outlet or cigarette lighter socket correctly?
- Is the charging jack of FOMA terminal dirty when you use desktop holder? If it is dirty, clean with a dry cotton swab.
- If you call or perform communication or operate other function for a long time while charging, the temperature of the FOMA terminal is raised and the light may turn off. When temperature is high, charging stops for safety. After using, wait until the temperature of the FOMA terminal drops and retry charging.

● Charging does not finish (battery level lowers while charging)

During a call or communications, charging may not finish. Battery level lowers and charging may not complete if you start battery charging while watching/recording 1Seg, playing moving picture/i-motion, obtaining Music&Video Channel program, activating Music&Video Channel player or MUSIC Player, running i-αppli. It is not defect in FOMA terminal. In this case, it is recommended to end the operation, and then charge the battery.

● Charging start sound beeps twice.

If you use FOMA Portable Charging Adapter 01 or 03 for charging, few seconds after the charging starts, the indicator may turn off for an instant and charging start sound may beep again to turn on the indicator. It is not a malfunction. The battery is being charged normally.

❖ Terminal operation

● Turning the power off or restarting automatically happens.

If the jack of battery pack is dirty, the contact may become poor and the power may shut OFF. If it is dirty, clean with a dry cotton swab.

● No operations are performed by pressing keypad.

Have you activated All lock, Omakase Lock, Side key hold, or Auto-key lock?

● The operation time provided by the battery pack is short.

- Is your terminal left for a long time under the state of out of service area? Out of service area, much power is consumed to search available radio waves.
- The operation time provided by the battery pack varies by the operating environment and battery pack's deterioration.
- The battery pack is a consumable part. Each time it is charged, time available with each charging reduces. Even the full charge state, when the operation time is too short, purchase a new battery pack of the specified type.

● The docomo mini UIM card is not recognized.

- Is the docomo mini UIM card installed in the right direction?

● **FOMA terminal etc. become hot while operating/charging.**

While operating or charging, or if you use i-appli, videophone call, 1Seg watching, etc. for a long time while charging the battery, FOMA terminal, battery pack and adapter may become hot. There is no problem about safety and continue to use it.

● **The clock is not on time.**

The clock time may become wrong while turning on the power for a long time. Set Auto time adjust of Date and time setting to "ON" and turn the power off and on in a place with strong radio wave conditions.

❖ **Calls**

● **Calls are not connected (Even when moving, "圏外 (out of service area)" does not disappear or although radio waves are enough, making/receiving calls is unavailable).**

- Turn the power off and on, or remove and attach the battery pack or the docomo mini UIM card.
- Even when the signal meter on your FOMA terminal indicates there are strong radio waves, due to the type of radio waves, making/receiving calls may be unavailable. Move to call again.
- Is Call rejection setting or 3G/GSM setting set?
- Due to the crossing of radio waves, at the crowded public places, calls/emails are crossed and the connection status may not be good. In this case, "Please wait for a while" appears and the caller hears a busy tone. Move to other place or call again at other time.

● **Calls cannot be made using the keypads.**

Have you activated All lock, Omakase Lock, Self mode, Keypad dial lock, Auto-key lock or Call/Mail of Function lock under Kid-safe mode?

❖ **Camera**

● **Still images or moving pictures taken with the camera are blurry**

- Make sure that the camera lens is not obscured or stained.
- Use Auto for Shoot by scene.
- Auto focus (Manual) or Tracking focus can also be used to focus.
- When shooting an object at a close range, set AF mode to "Closeup", and when shooting people, switch to "Face priority AF".
- Set Fix camera shake and shoot.

❖ **Osaifu-Keitai**

● **Osaifu-Keitai function is unavailable.**

- When removing the battery pack, IC card functions are unavailable regardless of the IC card lock settings.
- Have you activated Omakase Lock or IC card lock?
- Do you place  mark of FOMA terminal over IC card reader?

Warranty and After-Sales Service

Warranty

- FOMA terminal is provided with a written warranty. Make sure that you receive it. Check the written contents and items such as "販売店名・お買い上げ日 (Shop name/date of purchase)" and keep it in a safe place. If it does not contain the necessary information, immediately contact the shop where you bought it. The warranty is valid for a period of one year from the date of purchase.
- This product and all accessories are subject to change, in part or whole, for the sake of improvement without prior notice.

After-Sales Service

❖ When problems occur

Before requesting repair, read the section on "Troubleshooting" in this manual or in "使いかたガイド (Guide)" installed in FOMA terminal (in Japanese only). If the problem still persists, contact "Repairs" on the last page of this manual (in Japanese only).

❖ If the result of inquiries indicates that a repair is required

Take your FOMA terminal to DOCOMO-specified repair office. Be sure to check the opening hours of the office before you go. Note that, repair may take longer time depending on the state of damage.

In the warranty period

- FOMA terminal is repaired at no charge subject to the conditions of the warranty.
- The warranty must be presented to receive warranty service. The subscriber is charged for the repair of items not covered in the warranty or repairs of defects resulting from misuse (damage of the display/connector, etc.), accident, neglect, etc. even during the warranty period.
- The subscriber is charged even during the warranty period for the repair of failures caused by the use of devices or consumable items that are not DOCOMO-specified.

Repairs may not be possible in the following cases.

- When judged as malfunction due to moisture at the repair office (e.g. when detected in a moisture seal reaction)
- When corrosion due to moisture, condensation, perspiration, etc. is detected, or if any of the internal boards are damaged or deformed (repairs may not be possible if external connection jack (earphone/microphone jack) or display is damaged, or the terminal outer case is lifted)
- * Even in case that a repair is possible, since those conditions are outside the range of the warranty, a repair is charged.

After expiration of the warranty

All repairs that are requested are charged.

Replacement parts

Replacement parts (parts required to maintain the product functions) are basically kept in stock for at least 6 years after termination of production. However, repair may not be possible due to lack of repair parts etc.

❖ Notes

- Do not modify FOMA terminal or its accessories.
 - Repair may be refused depending on the nature of modification. The following cases may be regarded as modifications.
 - A sticker etc. is put on the display or keypad part
 - FOMA terminal is embellished with adhesive material etc.
 - Exteriors are replaced with other than DOCOMO's genuine parts
 - Repair of failures or damage caused by modification is charged even during the warranty period.
- Do not remove any inscription stickers attached to FOMA terminal.

If confirmation of the inscription sticker's content is impossible, determination of whether specific technical standards are satisfied cannot be made. Therefore, repair may be refused.
- Function settings and information may be cleared (reset) by malfunctions, repair or other handling of FOMA terminal. Should that happen, set up the functions again.
- Magnetic components are used in the earpiece, speaker, etc. of the FOMA terminal. Do not allow cash cards or other devices that are vulnerable to magnetism to come into contact with the phone.
- This FOMA terminal is waterproof. However, if inside of the terminal gets wet or moist, turn the power off, remove the battery pack immediately, and bring the terminal to a repair office as soon as possible. However, repair may not be possible depending on the condition of FOMA terminal.

Support

Error info send set.

Make settings to send error information to DOCOMO if an error occurs on your terminal.

- Information is sent at night. Packet communication fee is not charged.
- Personally identifiable information is not included.
- Some types of errors may not be recorded.

- 1 **MENU** ▶ 8 **Setting** ▶ 9 **Other setting** ▶
6 **Error info send set.** ▶ **Authenticate** ▶
1 **ON** or 2 **OFF**

Support

i-mode fault diagnosis site

Using your FOMA terminal, you can check whether sending/receiving of messages and downloading of images and melodies are normally performed. When FOMA terminal is assumed to have malfunctions as the result of the diagnosis, contact "Repairs" on the last page of this manual (in Japanese only).

i-mode site : iMenu⇒お知らせ

(Notice)⇒サポート情報

(Support information)⇒お問

い合わせ (Inquiries)⇒故障・電

波状況お問い合わせ先

(Checking malfunction/radio

wave condition)⇒ i モード故障診断 (i-mode fault diagnosis site) (In Japanese only)

- The access method may be changed without previous notice.
- Accessing from overseas is charged.



QR code
for site access

Updating software

This function allows you to connect the network and check if software in the FOMA terminal needs to be updated, if software update is necessary, download a part of software using packet communication and update the software. When software update is required, information is posted in "お客様サポート (user support)" on NTT DOCOMO website or iMenu (in Japanese only). Software may be updated in 3 methods: "Auto-update", "Immediate update" and "Reserved update".

* Software update can be done even when various data, such as a phonebook registered in FOMA terminal, camera images, downloaded data, are remaining; note that data protection sometimes cannot be secured according to the conditions of your FOMA terminal (such as malfunction, damage, or water leak). DOCOMO recommends backing up necessary data. However some data such as downloaded data may not be backed up.

❖ When updating software

- Do not remove the battery pack while updating software. The update may fail.
- Software update should be done with battery fully charged.
- Software update (downloading or rewriting) may take time.
- Making/Receiving calls, communications functions and other functions are disabled during software update (Only incoming voice calls can be answered while downloading).

- It is recommended that software update be executed in good radio wave conditions with three bars of the antenna icon displayed and the terminal not moved. If radio wave conditions become weaker during software download or the download is stopped, retry software update in a place with strong radio wave conditions.
- When updating software, your private information concerning FOMA terminal (model, serial number, etc.) is automatically sent to the server (the server for software update managed by DOCOMO). DOCOMO does not use the sent information for purposes except software update.
- When software update has failed, "Rewrite failed" appears and all operation becomes unavailable. In that case, please bring the FOMA terminal to DOCOMO-specified repair office.

Updating

From the stand-by display, select  (update notification icon), or start from the menu.

<Example> Starting from the update notification icon

1  ▶ Select  (update notification icon) ▶ "Yes" ▶ Authenticate

2 **The check result appears.**

When update is necessary, "Update is needed" appears. Select "Now update" or "Reserve".

<Example> Starting from the menu

1  ▶ 8 **Setting** ▶ 9 **Other setting** ▶ 5 **Software update** ▶ Authenticate ▶ "Update"

Scanning function (Security Scan)

For the data or programs that are imported to FOMA terminal, this function detects data and deletes data or inhibits activation of applications that may cause troubles.

- The Scanning function provides a certain countermeasure against invasion of data which causes some trouble in the mobile phone, when viewing website, receiving messages, etc. Note that, if pattern definition corresponding to specific troubles has not been downloaded to the mobile phone or such pattern definition does not exist, this function cannot prevent those troubles from occurring.



● Updating pattern definitions

Update pattern definition first, then keep the pattern definition up-to-date.

Set auto-update

You can set FOMA terminal so that pattern definitions can be automatically updated.

- 1 **MENU** ▶ 8 **Setting** ▶ 6 **Lock/Security** ▶
 6 **Scanning function** ▶ 2 **Set auto-update** ▶ "Enable" ▶ "Yes" ▶ "Yes" ▶
 "OK"

When the Auto-updating pattern definitions is executed,  or  appears on the stand-by display.

Scan result

Warning level	Actions
[0] Operation may not run properly.	"OK" : Continue processing of the started application
[1] Operation may not run properly. Cancel operation?	"Yes" : Stop processing of the application that may cause troubles "No" : Continue processing of the started application
[2] Operation may not run properly. Canceling operation.	"OK" : Stop processing of the application that may cause troubles
[3] Operation may not run properly. Delete data?	"Yes" : Delete data that may cause troubles "No" : Stop processing of the application that may cause troubles
[4] Operation may not run properly. Deleting data.	"OK" : Delete data that may cause troubles

*Selecting "Detail" on each screen displays a list of names of the detected problem elements. When 6 or more problem elements have been detected, the names of the 6th and subsequent problem names are omitted.

Options and related devices

Combining FOMA terminal with optional accessories supports a wide variety of uses from personal use to business use. Some products are unavailable depending on the area.

For details, contact a sales outlet such as docomo Shop. For details about the optional devices, refer to the instruction manual for each device.

- Battery Pack F19
- Back Cover F69
- FOMA AC Adapter 01/02*1
- Desktop Holder F33
- Carry Case L 01
- Carry Case 02
- Flat-plug Stereo Earphone Set P01*2
- Flat-plug Earphone/Microphone with Switch P01*2/P02*2
- Earphone Plug Adapter for External connector terminal 01
- Earphone Plug Adapter 01
- Stereo Earphone Set 01
- Earphone/Microphone 01
- FOMA USB Cable with Charge Function 02*3
- In-Car Holder 01
- FOMA DC Adapter 01/02
- In-Car Hands-Free Kit 01*4
- FOMA In-Car Hands-Free Cable 01
- FOMA USB Cable*3
- FOMA Dry Battery Adapter 01
- FOMA Portable Charging Adapter 01/02/03
- Earphone Plug Adapter P001*2
- Earphone/Microphone with Switch P001*5/
P002*5
- Stereo Earphone Set P001*5

- Remote controller with microphone F01*2
- Earphone Terminal P001*5
- FOMA AC Adapter for Global use 01*1
- FOMA Indoor Booster Antenna*6
- FOMA Indoor Booster Antenna (Stand Type)*6
- Bone conduction microphone/receiver 01*2
- FOMA eco Solar Panel 01
- Touch pen F01

*1 When using FOMA terminal overseas, use the adapter plug that is suitable for use in your travel destination. Also, do not charge the battery with a transformer for overseas travel.

*2 Earphone Plug Adapter for External connector terminal 01 is required to connect to F-06D.

*3 If you use USB HUB, operations may not be performed correctly.

*4 FOMA In-Car Hands-Free Cable 01 is required to use/charge F-06D.

*5 Earphone Plug Adapter for External connector terminal 01 and Earphone Plug Adapter P001 are required to connect to F-06D.

*6 Use this only in Japan.

Menu list

- Menu list for the case Select startup menu is set to "Basic menu" is described.
- Menus indicated in red can be restored to the default by executing Reset (including the menu whose partial sub content menu will be reset to the default).

■ Mail

Inbox	
Outbox	
Unsent messages	
Compose new message	
Create new Decome-Anime	
Decome-Template	Deco-mail
	Decome-Anime
Compose new SMS	
Check new mail/message	
Check new SMS	
Receive option	
Mail Setting	Receive setting
	Display
	Edit signature
	Common phrases/Store word
	Check new mail/message setting
	Reply setting
	Auto-reply
	Mail group
	Blog/Movie/SNS post setting
	Address/Spam setting
	Auto save setting when editing
	SMS settings
	Early warning "Area Mail" setting

Mail logs	Sent msg. log
	Received msg. log

■ i-mode/web

iMenu Search	
Bookmark	
Screen Memo	
Browsing history	
Enter URL	Enter URL
	URL enter history
i-Channel	i-Channel list
	Ticker display set.
	Reset i-Channel
RSS reader	
Access shortcuts	
i-mode/web setting	i-mode Browser Set.
	FB settings
	Common Settings
	Check i-mode setting
	Reset i-mode setting
Search engine	
Full Browser Home	
Smart Browser	Smart Browser
	Bookmark
	Browsing history
	URL enter/history
	Smart Browser setting

■ i-appli

Software list	
i-appli call logs	
i-appli run information	
i-appli setting	Sound effect volume
	Software info disp.
	Auto-start
	i-Widget settings
	AUTO-GPS preferred setting
	Sort software
	Display light time
	Brightness
	Vibration mode
	i-appli shortcuts
	i-appli power saver
	i-appli call DL set

■ CAMERA/TV/MUSIC

Camera	Still image shooting
	Graffiti picture
	Movie shooting
	Still image album
	Movie play
1Seg	Activate 1Seg
	Program guide
	1Seg image/video
	TV timer list
	Recording result
	TVlink
	Channel setting
	User setting
MUSIC Player	
Music&Video Channel	

■ Data Box

My picture
MUSIC
Music&Video Channel
i-motion/Movie
Melody
Content package
My document
Kisekai Tool
Machi-chara
Chara-den
1Seg
Other
My collection

■ Tool

Bar code reader	
Calculator	
Alarm	
Infrared/iC communications	Receive infrared data
	Send all infrared data
	All iC transmission
	Data exchange settings
Schedule	
Memo	
Voice recorder	
Mirror	
Countdown timer	

Data Security Service	Data check/Download
	Update phonebooks
	Update schedule etc
	Update images
	Update setting information
	Detailed setting/Exchanging history

microSD

Guide

Dictionary	Jpn Dic (Gakken Mobile Jpn Dic)
	JE Dic (Gakken Mobile JE Dic)
	EJ Dic (Gakken Mobile EJ Dic)
	Today's trivia
	Today in history

Pedometer/ACT monitor	Steps/Activity/Calories info
	Set Pedometer/Activity monitor

Common phrases/Store word	Common phrases
	Store word

Download dictionary

Voice quick start

Shabette-Kensaku

Contact DOCOMO	ドコモ総合案内・受付
	ドコモ故障問合せ
	海外紛失・盗難等
	海外故障

■ TEL function

Phonebook	Search phonebook
	Add to phonebook
	UIM operation
	Add group

Record message/Voice memo	Record message list
	Voice memo list
	Record voice memo
	Record message

Dialed/Received calls	Received calls
	Redial

Dial/Receive call setting	Nuisance call blocking service
	Caller ID request
	Caller ID notification
	Arrival call act
	Dial call detailed setting
	Receive call detailed setting
	In-call detailed setting
	Headset function setting
	Call rejection setting
	Missed call notification
	Sound & Image

Videophone setting	V.phone dialing img.
	Videophone receiving
	Data session arv. Act
	Operation
	Image setting
	Notify switchable mode
External device	

Call duration/charge	Call charge
	Call duration
	Reset call cost
	Call cost limit
	Hide call cost icon

Disaster Voice Messaging

Koe-no-Takuhaibin	Message confirm/set(site)
	Message confirm(voice)
	Settings(voice)

2in1	2in1 mode switching
	Ph.book 2in1 setting
	Stand-by display setting
	Call/receive settings
	2in1 function OFF
	Receive avoidance
Melody call	
Voice mail service	Activate
	Ring time
	Deactivate
	Check setting
	Play messages
	Setting
	Check messages
	Tone/Vibration message notification
Delete icon	
	Setting for videophone
Other network service	Call forwarding
	Call waiting
	English guidance
	Remote access
	Multi Number
	Dual network
	Additional service
	OFFICEED
Fake call	Activate
	Alert&Time settings

Setting	
Screen/Display	Kisekae Tool setting
	Stand-by display setting
	MyFACE setting
	Color theme setting
	Each display setting
	Machi-chara setting
	Menu preference
	Auto light on
	Privacy view level
	Sub-display animation
Sound/Vibration/Manner	Ring tone
	Other sounds
	Adjust volume
	Vibration mode
	Silent mode
	BGM play
	Machi-chara chat setting
Backlight/Illumination	Display light
	Light alert
	KeypadILLUM settings
Text display/input	Font size
	Font style
	Text input
	バイリンガル
	Discreet display mode
Time	Date and time setting
	Clock format
	Auto power ON/OFF
	Time tone setting
	Phone refresh

Lock/Security	Locks	
	Privacy mode	
	Change security code	
	Security indicator	
	Kid-safe mode	
	Scanning function	
	Password manager	
	microSD password setting	
	UIM setting	
	Call rejection setting	
	IC card lock	
	Caller/Sender info	
	Battery	eco mode setting
		eco mode auto-start set.
Battery level		
Battery icon setting		
External connection	USB mode	
	Femtocell	
	Data exchange settings	
	Backup/Restore	
Other setting	Self mode	
	Initial setting	
	Delete all data	
	Reset	
	Software update	
	Error info send set.	
	Check remote setting	
	Memory status	
	Side key shortcut	
	Motion sensor	
Touch panel correction		

Kisekae/Themes	Kisekae Tool
	Style theme
	Timed theme
■ Map/Overseas	
Map	
Navigation	
imadoco search	imadoco kantan search
	imadoco search
i-area	
GPS appli list	
Position location/Location notification	Position location
	Notify location
Maps&GPS setting/history	Loc. history
	Map setting
	GPS button setting
	Request permit/deny
	AUTO-GPS
	Positioning mode setting
	LCS clients list
	Service setting
	Service host URL setting
	Light color/Alert
Overseas network search	3G/GSM setting
	Network search setting
	PLMN setting
	Display operator name setting
	Display area status
	Re-search icon display setting

Overseas setting	Inquiries(overseas)
	Barring incoming call when roaming
	Missed call notification for roaming
	Roaming guidance
	International dialing assist
	i-mode service setting
	Mail/Message usage setting
Network service	
Overseas user's guide	

■ i-concier

i-concier

■ Profile

Profile

■ OsaiFu-Keitai

IC card content

DCMX

ToruCa

IC card lock setting

IC card lock

Timed lock

Programed activation

IC lock(power-off)

Setting

ToruCa from IC card

ToruCa from 1Seg

ToruCa duple check

ToruCa auto-read

ToruCa auto display

ToruCa sound effect

IC card usage

Check IC owner

Change IC owner

Search by i-mode

Main specifications

■ Phone

Product name		F-06D
Size		Approx. 111 mm (H)×51 mm (W)×13.5 mm (T) (Thickest part : Approx. 17.2 mm)
Weight		Approx. 120 g (with battery)
Continuous stand-by time^{*1, 2, 3}	FOMA/3G	Stationary (Auto) : Approx. 530 H
	GSM	Stationary (Auto) : Approx. 260 H
Continuous call time^{*2, 3, 4}	FOMA/3G	Voice call : Approx. 210 min. Videophone call : Approx. 90 min.
	GSM	Approx. 230 min.
1Seg watching time^{*2, 5}		Approx. 200 min.
Charging time^{*6}		AC adapter : Approx. 130 min. DC adapter : Approx. 130 min.
Display	Type	Display : TFT 16,777,216 colors Sub-display : Organic EL 1 color
	Size	Display : Approx. 3.3 inches Sub-display : Approx. 0.8 inches
	Number of pixels	Display : 409,920 pixels (480×854 dots) Sub-display : 3,744 pixels (39×96 dots)
Image pickup device	Type	OUT camera : CMOS IN camera : CMOS
	Size	OUT camera : 1/3.2 inches IN camera : 1/6 inches
	Number of effective pixels	OUT camera : Approx. 8,100,000 pixels IN camera : Approx. 1,300,000 pixels

Camera section	Number of recording pixels (Max.)	OUT camera : Approx. 8,000,000 pixels IN camera : Approx. 1,300,000 pixels
	Zoom (digital)	OUT camera : Up to approx. 13.9x (still image), up to approx. 16.0x (moving picture) IN camera : Up to approx. 2.0x
Recording section	Savable still images^{*7}	Up to approx. 1,400 images (default)
	Continuous shooting of still images	7
	File format for still image	JPEG
	Moving picture shooting time^{*8}	Up to approx. 376 sec. (save to phone) Up to approx. 60 min. (save to 2GB microSD card)
	Moving picture file format	MP4
Playing music	1Seg recording time	Up to approx. 30 min. (save to phone/default) Up to approx. 640 min. (save to 2GB microSD card)
	Continuous play time	i-motion : Approx. 626 min. ^{*9} Chaku-uta full : Approx. 3,688 min. ^{*9, 10} WMA file : Approx. 3,734 min. ^{*10} Music&Video Channel (sound) : Approx. 3,688 min. ^{*10} Music&Video Channel (moving picture) : Approx. 216 min.

Recording size	Chaku-uta/ Chaku-uta full	Approx. 91MB (F-06D Girls' : Approx. 88 MB)
	Chaku-uta full	Approx. 91 MB (F-06D Girls' : Approx. 88 MB)

- *1 Continuous stand-by time indicates the estimated time when FOMA terminal is closed and able to receive radio waves normally. Stationary continuous stand-by time indicates the average utilization time FOMA terminal is closed and able to receive radio waves normally remains stationary.
- *2 Call, communication or stand-by time may be reduced to about half, or 1Seg watching time may be reduced due to battery pack charging condition, function settings, operating environment such as ambient temperature, radio wave conditions in the area of use (the radio waves are weak or absent), etc.
- *3 Without making calls or i-mode communications, the call, communication or stand-by times are reduced by frequently using camera, 1Seg, i-αppli, AUTO-GPS, etc.
- *4 Continuous call time indicates the approximate time that the phone can send or receive radio waves normally.
- *5 1Seg watching time indicates the approximate watching time with receiving radio waves normally and using Stereo Earphone Set 01 (optional).
- *6 Charging time indicates the estimated time for charging an empty battery with FOMA terminal turned OFF. Charging with FOMA terminal turned ON or charging in lower temperature requires longer time.
- *7 The number of savable still images is based on "QVGA (320×240)" in Image Size, "NORMAL" in Image quality and 25 Kbytes in file size.
- *8 The moving picture shooting time means allowable time for one shooting. The number is based on "VGA (640×480)" in Select size and "NORMAL" in Image quality. Varies depending on the moving picture to be recorded.
- *9 AAC format files.
- *10 Background playing is available.

■ Battery Pack

Quality	Battery Pack F19
Battery used	Li-ion battery
Nominal voltage	3.7V
Nominal capacity	820mAh

Savable/Recordable/ Protectable number

Type	Savable/Recordable number	Protectable number
Phonebook*1	Up to 2,000	—
UIM phonebook	Up to 50	—
Kisekai Tool*1	Up to 50	—
Mail*1, 2	Received messages	Up to 2,500
	Sent messages	Up to 500
	Unsent messages	Up to 500
Area Mail	Up to 30	—
Bookmark*3	Up to 200	—
Screen memo*1, 4	Up to 400	Up to 400
Music*1	Chaku-uta full	Up to 30 (F-06D Girls' : Up to 29)
	Uta-moji Lyrics	Up to 100
i-αppli*1, 5	Up to 100	—
Images*1, 6	Up to 5,000	—
Moving picture/i-motion*1	Up to 200	—
Melodies*1	Up to 500	—
Video recorded in 1Seg*1	Up to 10	—
Note/Schedule*1, 7	Up to 2,600	—

- *1 Depending on the size of data or usage status of common memory space, the actual number of items that can be saved and recorded may be fewer.
- *2 The total number of i-mode mail and SMS.
- *3 The total number of i-mode, Full Browser and Smart Browser.
- *4 The total number of i-mode and Full Browser.
- *5 Total number of i-αppli and Message i-αppli. Up to 5 items of Message i-αppli can be saved.
- *6 Total number of images and still images recorded in 1Seg.
- *7 Total number of notes/schedules, schedules in i-schedule and watching/recording reservation. Up to 100 items of watching/recording reservation in total can be saved.

Specific Absorption Rate (SAR) of Mobile Phones

This model F-06D mobile phone complies with Japanese technical regulations and international guidelines regarding exposure to radio waves.

This mobile phone was designed in observance of Japanese technical regulations regarding exposure to radio waves (*1) and limits to exposure to radio waves recommended by a set of equivalent international guidelines. This set of international guidelines was set out by the International Commission on Non-Ionizing Radiation Protection (ICNIRP), which is in collaboration with the World Health Organization (WHO), and the permissible limits include a substantial safety margin designed to assure the safety of all persons, regardless of age and health condition.

The technical regulations and international guidelines set out limits for radio waves as the Specific Absorption Rate, or SAR, which is the value of absorbed energy in any 10 grams of tissue over a 6-minute period. The SAR limit for mobile phones is 2.0 W/kg. The highest SAR value for this mobile phone when tested for use at the ear is 0.740 W/kg. There may be slight differences between the SAR levels for each product, but they all satisfy the limit.

The actual SAR of this mobile phone while operating can be well below that indicated above. This is due to automatic changes to the power level of the device to ensure it only uses the minimum required to reach the network. Therefore in general, the closer you are to a base station, the lower the power output of the device. This mobile phone can be used in positions other than against your ear. This mobile phone satisfies the international guidelines when used with a carrying case or a wearable accessory approved by NTT DOCOMO, INC. (*2) In case you are not using the approved accessory, please use a product that does not contain any metals, and one that positions the mobile phone at least 1.5 cm away from your body.

The World Health Organization has stated that "a large number of studies have been performed over the last

two decades to assess whether mobile phones pose a potential health risk. To date, no adverse health effects have been established as being caused by mobile phone use."

Please refer to the WHO website if you would like more detailed information.

http://www.who.int/docstore/peh-emf/publications/facts_press/fact_english.htm

Please refer to the websites listed below if you would like more detailed information regarding SAR.

Ministry of Internal Affairs and Communications Website: <http://www.tele.soumu.go.jp/e/sys/ele/index.htm>

Association of Radio Industries and Businesses

Website: <http://www.arib-emf.org/index02.html> (in Japanese only)

NTT DOCOMO, INC. Website: [http://](http://www.nttdocomo.co.jp/english/product/sar/)

www.nttdocomo.co.jp/english/product/sar/

FUJITSU LIMITED Website: <http://www.fmworlworld.net/product/phone/sar/> (in Japanese only)

*1 Technical regulations are defined by the Ministerial Ordinance Related to Radio Law (Article 14-2 of Radio Equipment Regulations).

*2 Regarding the method of measuring SAR when using mobile phones in positions other than against the ear, international standards (IEC62209-2) were set in March of 2010. On the other hand, technical regulation is currently being deliberated on by national council. (As of November, 2011)

Declaration of Conformity

● ● ●

The product "F-06D" is declared to conform with the essential requirements of European Union Directive 1999/5/EC Radio and Telecommunications Terminal Equipment Directive 3.1(a), 3.1(b) and 3.2. The Declaration of Conformity can be found on <http://www.fmworlworld.net/product/phone/doc/>.

This mobile phone complies with the EU requirements for exposure to radio waves.

Your mobile phone is a radio transceiver, designed and manufactured not to exceed the SAR^{*} limits^{**} for exposure to radio-frequency(RF) energy, which SAR^{*} value, when tested for compliance against the standard was 0.57W/kg. While there may be differences between the SAR^{*} levels of various phones and at various positions, they all meet^{***} the EU requirements for RF exposure.

-
- * The exposure standard for mobile phones employs a unit of measurement known as the Specific Absorption Rate, or SAR.
 - ** The SAR limit for mobile phones used by the public is 2.0 watts/kilogram (W/Kg) averaged over ten grams of tissue, recommended by The Council of the European Union. The limit incorporates a substantial margin of safety to give additional protection for the public and to account for any variations in measurements.
 - *** Tests for SAR have been conducted using standard operation positions with the phone transmitting at its highest certified power level in all tested frequency bands. Although the SAR is determined at the highest certified power level, the actual SAR level of the phone while operating can be well below the maximum value. This is because the phone is designed to operate at multiple power levels so as to use only the power required to reach the network. In general, the closer you are to a base station antenna, the lower the power output.

Federal Communications Commission (FCC) Notice

- This device complies with part 15 of the FCC rules. Operation is subject to the following two conditions :
 - ① this device may not cause harmful interference, and
 - ② this device must accept any interference received, including interference that may cause undesired operation.
- Changes or modifications made in or to the radio phone, not expressly approved by the manufacturer, will void the user's authority to operate the equipment.

FCC RF Exposure Information

This model phone meets the U.S. Government's requirements for exposure to radio waves. This model phone contains a radio transmitter and receiver. This model phone is designed and manufactured not to exceed the emission limits for exposure to radio frequency (RF) energy as set by the FCC of the U.S. Government. These limits are part of comprehensive guidelines and establish permitted levels of RF energy for the general population. The guidelines are based on standards that were developed by independent scientific organizations through periodic and thorough evaluation of scientific studies.

The exposure standard for wireless mobile phones employs a unit of measurement known as the Specific Absorption Rate (SAR). The SAR limit set by the FCC is 1.6 W/kg. Tests for SAR are conducted using standard operating positions as accepted by the FCC with the phone transmitting at its highest certified power level in all tested frequency bands. Although the SAR is determined at the highest certified power level, the actual SAR level of the phone while operating can be well below the maximum value. This is because the phone is designed to operate at multiple power levels so as to use only the power required to reach the network. In general, the closer you are to a wireless base station antenna, the lower the power output level of the phone.

Before a phone model is available for sale to the public, it must be tested and certified to prove to the FCC that it does not exceed the limit established by the U.S. government-adopted requirement for safe exposure.

The tests are performed on position and locations (for example, at the ear and worn on the body) as required by FCC for each model. The highest SAR value for this model phone as reported to the FCC, when tested for use at the ear, is 0.507W/kg, and when worn on the body, is 0.274W/kg. (Body-worn measurements differ among phone models, depending upon available accessories and FCC requirements).

While there may be differences between the SAR levels of various phones and at various positions, they all meet the U.S. government requirements.

The FCC has granted an Equipment Authorization for this model phone with all reported SAR levels evaluated as in compliance with the FCC RF exposure guidelines. SAR information on this model phone is on file with the FCC and can be found under the Equipment Authorization Search section at <http://www.fcc.gov/oet/ea/fccid/> (please search on FCC ID VQK-F06D).

For body worn operation, this phone has been tested and meets the FCC RF exposure guidelines when used with an accessory designated for this product or when used with an accessory that contains no metal and which positions the handset at a minimum distance of 1.5 cm from the body.

* In the United States, the SAR limit for wireless mobile phones used by the general public is 1.6 Watts/kg (W/kg), averaged over one gram of tissue. SAR values may vary depending upon national reporting requirements and the network band.

This equipment has been tested and found to comply with the limits for a Class B digital device, pursuant to part 15 of the FCC Rules.

These limits are designed to provide reasonable protection against harmful interference in a residential installation. This equipment generates, uses and can radiate radio frequency energy and, if not installed and used in accordance with the instructions, may cause harmful interference to radio communications.

However, there is no guarantee that interference will not occur in a particular installation.

If this equipment does cause harmful interference to radio or television reception, which can be determined by turning the equipment off and on, the user is encouraged to try to correct the interference by one or more of the following measures:

- Reorient or relocate the receiving antenna.
- Increase the separation between the equipment and receiver.
- Connect the equipment into an outlet on a circuit different from that to which the receiver is connected.
- Consult the dealer or an experienced radio/TV technician for help.

Important Safety Information

AIRCRAFT

Switch off your wireless device when boarding an aircraft or whenever you are instructed to do so by airline staff. If your device offers flight mode or similar feature consult airline staff as to whether it can be used on board.

DRIVING

Full attention should be given to driving at all times and local laws and regulations restricting the use of wireless devices while driving must be observed.

HOSPITALS

Mobile phones should be switched off wherever you are requested to do so in hospitals, clinics or health care facilities. These requests are designed to prevent possible interference with sensitive medical equipment.

PETROL STATIONS

Obey all posted signs with respect to the use of wireless devices or other radio equipment in locations with flammable material and chemicals. Switch off your wireless device whenever you are instructed to do so by authorized staff.

INTERFERENCE

Care must be taken when using the phone in close proximity to personal medical devices, such as pacemakers and hearing aids.

Pacemakers

Pacemaker manufacturers recommend that a minimum separation of 15 cm be maintained between a mobile phone and a pace maker to avoid potential interference with the pacemaker. To achieve this use the phone on the opposite ear to your pacemaker and does not carry it in a breast pocket.

Hearing Aids

Some digital wireless phones may interfere with some hearing aids. In the event of such interference, you may want to consult your hearing aid manufacturer to discuss alternatives.

For other Medical Devices :

Please consult your physician and the device manufacturer to determine if operation of your phone may interfere with the operation of your medical device.

Appendix

Export Administration Regulations

This product and its accessories may be under coverage of the Export Administration Regulations of Japan ("Foreign Exchange and Foreign Trade Control Laws" and the related laws and regulations). When exporting this product and its accessories, take necessary procedures on your responsibility and expense. For details, contact Ministry of Economy, Trade and Industry of Japan.

Intellectual Property Right

Copyrights and portrait rights

Except for the case protected by copyright laws such as personal use, use of FOMA terminal to reproduce, alter, or publicly transmit recorded pictures or sounds, or copyrighted text, images, music or software downloaded from websites without the copyright holder's authorization is prohibited.

Note that taking photos or recordings at some demonstrations, performances or exhibitions may be prohibited even when only for personal use.

Avoid taking pictures of others with FOMA terminal without their consent or disclosing recorded pictures of others without their consent to general public through Internet websites etc., because they may infringe on portrait rights.

Trademarks

Company and product names mentioned in this manual are trademarks or registered trademarks of their respective holders.

- "FOMA", "i-mode", "i-appli", "i-motion", "Deco-mail", "Chara-den", "ToruCa", "WORLD CALL", "DCMX", "i-area", "WORLD WING", "OFFICEED", "2in1", "docomo STYLE series" and logos of "i-mode", "i-appli", "Music&Video Channel", "iC" are trademarks or registered trademarks of NTT DOCOMO.
- "Catch Phone (Call waiting service)" is a registered trademark of Nippon Telegraph and Telephone Corporation.
- McAfee® is registered trademarks or trademarks of McAfee, Inc. and/or its affiliates in the US and/or other countries.
- Rovi, G-GUIDE, G-GUIDE MOBILE and G-Guide related logos are trademarks or registered trademarks of Rovi Corporation and/or its subsidiaries in Japan.
- This product contains Adobe® Flash® Lite® and Adobe Reader® Mobile technology of Adobe Systems Incorporated. Adobe Flash Lite Copyright© 2003-2011 Adobe Systems Incorporated. All rights reserved. Adobe Reader Mobile Copyright© 1993-2011 Adobe Systems Incorporated. Adobe, Adobe Reader and Flash Lite are either registered trademarks or trademarks of Adobe Systems Incorporated in the United States and/or other countries.



- This product contains NetFront Browser, NetFront Document Viewer and NetFront Sync Client of ACCESS CO., LTD. ACCESS, the ACCESS logo and NetFront are registered trademarks or trademarks of ACCESS CO., LTD. in the United States, Japan and/or other countries. Copyright © 2011 ACCESS CO., LTD. All rights reserved.
- Powered by JBlend™ Copyright 2002-2011 Aplix Corporation. All rights reserved. JBlend and JBlend-related trademarks are trademarks or registered trademarks of Aplix Corporation in Japan and other countries.
-  is a registered trademark of FeliCa Networks, Inc.
- FeliCa is a registered trademark of Sony Corporation.
- QR code is a registered trademark of Denso Wave Inc.
- microSDHC Logo is a trademark of SD-3C, LLC.
- "Multitask" is a registered trademark of NEC Corporation.
- QuickTime is a registered trademark of Apple Inc., in the US and other countries.
- Microsoft®, Windows®, Windows Media®, Windows Vista® and PowerPoint® are trademarks or registered trademarks of "Microsoft Corporation" in the US and other countries.
- Microsoft Excel and Microsoft Word are product names of Microsoft Corporation in the U.S.A. In this manual, they may be described as Excel and Word.

ACCESS™ NetFront™



- The abbreviations of operating systems (Japanese versions) below are used in this manual.
 - Windows 7 stands for Microsoft® Windows® 7 (Starter, Home Basic, Home Premium, Professional, Enterprise and Ultimate).
 - Windows Vista stands for Windows Vista® (Home Basic, Home Premium, Business, Enterprise and Ultimate).
 - Windows XP indicates the Microsoft® Windows® XP Professional operating system or Microsoft® Windows® XP Home Edition operating system.
- Manufactured under license from Dolby Laboratories. Dolby and the double-D symbol are trademarks of Dolby Laboratories.
- iWnn of OMRON SOFTWARE Co., Ltd. is used for conversion methods for Japanese language, and for phrase prediction methods for English. iWnn© OMRON SOFTWARE Co., Ltd. 2008-2011 All Rights Reserved.
- "AXIS Font" is a trademark of AXIS Inc., and the "AXIS" font is a font developed by Type Project Inc.
- This product contains software licensed by Symbian Foundation Limited. Symbian is a registered trademark of Symbian Foundation Limited.
- "Privacy mode" is a registered trademark of FUJITSU LIMITED.
- "Uni-Type" is a universal designed font jointly developed by LIM Corp., Ltd. and Faculty of Engineering, Chiba University. Uni-Type is a registered trademark of LIM Corp., Ltd.
- "丸ゴシック (Maru Gothic)", "レイミン (Reimin)" and "丸フォーク (Maru Fork)" are provided by Morisawa & Company, Ltd. and the copyrights of these font data belong to them. Names of "レイミン (Reimin)" and "丸フォーク (Maru Fork)" are their trademarks.
- OBEX™, IrSimple™, IrS™ and IrSimpleShot™ are trademarks of Infrared Data Association.





- Blu-ray Disc and its logo are trademarks.
- "くーまん" is a trademark of Dora communications CO.,LTD.
- Other company and product names mentioned in this manual are trademarks or registered trademarks of their respective holders.

Others

- This product contains a module developed by the Independent JPEG Group.
- FeliCa is a contactless IC card technology developed by Sony Corporation.
- This product contains software licensed based on Apache License V2.0. and altered as necessary by NTT DOCOMO, INC.

This product contains software licensed complying with GNU Lesser General Public License (LGPL), Eclipse Public License (EPL), etc.

For more details, on the FOMA terminal,  ⇒

   ⇒ "その他 (Others)" to see in "オープンソースライセンス (Open source license)".

The source code of the used open source software is disclosed according to the rules of LGPL (<http://www.gnu.org/licenses/>), EPL (<http://www.eclipse.org/legal/epl-v10.html>), MPL (<http://www.mozilla.org/MPL/MPL-1.1.html>) and NPL (<http://www.mozilla.org/MPL/NPL-1.1.html>). For more details, refer to the information on this product in the following site.

<http://www.fmworld.net/product/phone/fp/sb/develop/>

- This product is licensed based on MPEG-4 Visual Patent Portfolio License. The use of MPEG-4 Video Codec function is allowed for personal and nonprofit use only in the cases below.
 - Recording moving pictures and i-motion that conform to MPEG-4 Visual Standard (hereinafter referred to as MPEG-4 Video)
 - Playing MPEG-4 Videos recorded personally by consumers not engaged in profit activities
 - Playing MPEG-4 Video supplied from the provider licensed from MPEG-LA
 - For further utilizing such as promotion, in-house use or profit-making business, please contact MPEG LA, LLC in U.S.
- Content owners use Windows Media digital rights management technology (WMDRM) to protect their intellectual property, including copyrights. This device uses WMDRM software to access WMDRM-protected content. If the WMDRM software fails to protect the content, content owners may ask Microsoft to revoke the software's ability to use WMDRM to play or copy protected content. Revocation does not affect unprotected content. When downloading licenses for protected content, you agree that Microsoft may include a "Revocation List" with the licenses. Content owners may require you to upgrade WMDRM to access their content. If you decline an upgrade, you cannot access a content that requires the upgrade.

- The HMM-Based Speech Synthesis Engine embedded in this product uses the Simplified BSD License.

The HMM-Based Speech Synthesis System (HTS)
hts_engine API developed by HTS Working Group
<http://hts-engine.sourceforge.net/>

Copyright© 2001-2010 Nagoya Institute of
Technology, Department of Computer Science
2001-2008 Tokyo Institute of Technology,
Interdisciplinary Graduate School of Science and
Engineering

All rights reserved.

Redistribution and use in source and binary forms,
with or without modification, are permitted provided
that the following conditions are met:

- Redistributions of source code must retain the
above copyright notice, this list of conditions and
the following disclaimer.
- Redistributions in binary form must reproduce the
above copyright notice, this list of conditions and
the following disclaimer in the documentation and/
or other materials provided with the distribution.
- Neither the name of the HTS working group nor the
names of its contributors may be used to endorse
or promote products derived from this software
without specific prior written permission.

THIS SOFTWARE IS PROVIDED BY THE COPYRIGHT
HOLDERS AND CONTRIBUTORS "AS IS" AND ANY
EXPRESS OR IMPLIED WARRANTIES, INCLUDING,
BUT NOT LIMITED TO, THE IMPLIED WARRANTIES
OF MERCHANTABILITY AND FITNESS FOR A
PARTICULAR PURPOSE ARE DISCLAIMED. IN NO
EVENT SHALL THE COPYRIGHT OWNER OR
CONTRIBUTORS BE LIABLE FOR ANY DIRECT,
INDIRECT, INCIDENTAL, SPECIAL, EXEMPLARY, OR
CONSEQUENTIAL DAMAGES (INCLUDING, BUT
NOT LIMITED TO, PROCUREMENT OF SUBSTITUTE
GOODS OR SERVICES; LOSS OF USE, DATA, OR
PROFITS; OR BUSINESS INTERRUPTION)
HOWEVER CAUSED AND ON ANY THEORY OF
LIABILITY, WHETHER IN CONTRACT, STRICT
LIABILITY, OR TORT (INCLUDING NEGLIGENCE OR
OTHERWISE) ARISING IN ANY WAY OUT OF THE
USE OF THIS SOFTWARE, EVEN IF ADVISED OF THE
POSSIBILITY OF SUCH DAMAGE.

Index

A

AC adapter	24
Adjust volume	32
After-Sales Service	77
Alarm	69
All lock	38
Attachments	48
AUTO-GPS	56
Auto-key lock	38

B

Back Cover	23
Backup at once	72
Bar code reader	70
Battery pack	23
Bookmark	53
Browsing i-mode website	52

C

Call Forwarding Service	44
Call rejection setting	39
Call Waiting Service	44
Caller ID notification	25
Camera	57
Chaku-uta full	63
Channel list	60
Character entry	30
Charging	24
Checking new mail/message	50
Common phrases	31

D

Deco-mail	49
-----------------	----

Decome-Anime	49
Delete all data	39
Desktop Holder	24
Display light	33
Displaying phone number	25
Displaying web pages	52
DOCOMO Connection Manager	74
DOCOMO keitai datalink	74
docomo mini UIM card	23
docomo Palette UI	29

E

Early warning "Area Mail"	51
eco mode	35
eco mode auto-start set.	35
Emergency call	45
Error info send set.	78

F

FeliCa (OsaiFu-Keitai)	66
Focus mode	27
Font size	33
Full Browser	52

G

GPS function	55
Graffiti picture	59
Guide	29
Guide area	28

I

i-appli	64
IC card lock	38

iC transmission	73
i-Channel	54
Icon	26
i-concier	67
i-mode fault diagnosis site	78
i-mode password	36
i-motion/Movie	65
Incoming call restriction	39
Indicator light	35
Information	67
Infrared communication	73
Initial setting	25
Input mode	30
International calls	41
International Roaming	46
i-Widget	64

K

Keypad dial lock	38
Kisekae Tool	34
Koe-no-Takuhaibin	41

L

Light alert	35
Listening volume	42
Lock on close	38

M

Machi-chara setting	34
Making a call	40
Making a videophone call	40
Map	55
Menu List	82
Menu operation	28
microSD card	71
Moving picture display	58
MUSIC Player	63

Music&Video Channel	62
MyFACE	29

N

Navigation	55
Network security code	36
Network service	44

O

Omakase Lock	38
On hold	42
Open assist button	6
Options and related devices	81
OsaiFu-Keitai	66
Overseas use	46

P

PC connection	74
Personal alarm	70
Phonebook	40, 51
Pictogram	31
PIN1/PIN2 code	36
Position location	55
Privacy view	33
Profile	25
Program setting	62
Public mode	43
PUK code	37

Q

QR code	70
Quick schedule	69

R

Receive setting	51
Received calls	40

Receiving a call	42
Receiving a videophone call	42
Receiving i-mode mail	50
Record message	43
Recording reservation	61
Redial	40
Replying to mail	50
Reset	39
Ring tone	32

S

SAR	90
Savable/Recordable/Protectable number	89
Scanning function	80
Schedule	69
Screen Memo	53
Security code	36
Security Scan	80
Select startup menu	33
Self mode	38
Sending i-mode mails	48
Sending SMS	48
Set auto-update	80
Setting mail sort rule	50
Shabette-Kensaku	68
Shooting moving pictures	57
Shooting still images	57
Shortcut	29
Silent mode	32
Smart Browser	52
Smileys	31
Specification	88
Stand-by display setting	33
Still image display	58
Symbol	31
System sound	32

T

Terminal security code	36
Text input	31
Troubleshooting	75

U

Unoperated lock setting	38
Updating software	79
USB mode	74

V

Vibration mode	32
Voice Mail Service	44
Voice quick start	68

W

Warranty	77
Watching reservation	61
Web capture	53
WMA file	63
WORLD CALL	41
WORLD WING	46

Numeric

1Seg	60
1Seg alarm	69

Please ask checking/changing subscription detail, application of various services and request of various information materials online.

From i-mode iMenu ⇒ お客様サポート (Support) ⇒ お申込・お手続き (Application/Procedures) ⇒ 各種お申込・お手続き (Various application/Procedures)

No packet communication charges * In Japanese only

From PCs My docomo (<http://www.mydocomo.com/>) ⇒ 各種お申込・お手続き (Various application/Procedures) * In Japanese only

- * You need your "Network security code" to use the site from i-mode.
- * No packet communication charge applies to access the site from i-mode. Packet communication charge applies to access from overseas.
- * You need "docomo ID/Password" to access the site from your PC.

- * If you do not have or forget "Network security code" or "docomo ID/Password", contact to the numbers for "General Inquiries" on the last page of this manual.
- * You may not use the services depending on your subscription.
- * There are cases where the site may not be available to system maintenance, etc.



Using mobile phone with your manners!

When using your mobile phone in a public place, don't forget to show common courtesy and consideration for others around you.

Always turn OFF your FOMA terminal in cases below

- In a place where use of mobile phones is prohibited
- ・ Always turn OFF your FOMA terminal in an aircraft or hospital.

Always set Public mode in cases below

- When driving
 - ・ Using a mobile phone by holding it with the hand while driving is subject to penalty.
- In public places such as a theater, movie theater or art museum

Consider privacy



Please be considerate of the privacy of individuals around you when taking and sending photos using camera-equipped mobile phones.



DOCOMO's environmental effort

Fewer pages in the instruction manual

In Japanese version, instruction manual covers instructions only for basic functions to reduce pages and paper usage.

For frequently-used functions and their details, see 使いかたガイド (Guide) (installed in this FOMA terminal, in Japanese only) or visit NTT DOCOMO website.

Recycle of mobile phones

To protect environment and recycle the precious resources, mobile phone and PHS enterprises collect phones, batteries and chargers, regardless of brands and manufacturers, at shops labeled with the mark shown to the left. Bring these devices to your nearest docomo Shop.



General Inquiries
<docomo Information Center>

☎ 0120-005-250 (toll free)

* Service available in: English, Portuguese, Chinese, Spanish, Korean.
* Unavailable from part of IP phones.

(Business hours : 9:00 a.m. to 8:00 p.m.)

■ From DOCOMO mobile phones (In Japanese only)

☎ (No prefix) 151 (toll free)

* Unavailable from land-line phones, etc.

■ From land-line phones (In Japanese only)

☎ 0120-800-000 (toll free)

* Unavailable from part of IP phones.

(Business hours : 9:00 a.m. to 8:00 p.m. (open all year round))

● Please confirm the phone number before you dial.

● For Applications or Repairs and After-Sales Service, please contact the above-mentioned information center or the docomo shop etc. near you on the NTT DOCOMO website or the i-mode site.

▶ NTT DOCOMO website <http://www.nttdocomo.co.jp/english/>

▶ i-mode site iMenu⇒お客様サポート (user support)⇒ドコモショップ (docomo Shop) * In Japanese only

Loss or theft of FOMA terminal or payment of cumulative cost overseas
<docomo Information Center>

(available 24 hours a day)

■ From DOCOMO mobile phones

**International call access code
for the country you stay**

-81-3-6832-6600* (toll free)

* You are charged a call fee to Japan when calling from a land-line phone, etc.

※ If you use F-06D, you should dial the number +81-3-6832-6600 (to enter '+', press and hold the '0' key for at least one second).

■ From land-line phones <Universal number>

**Universal number
international prefix**

-8000120-0151*

* You might be charged a domestic call fee according to the call rate for the country you stay.

※ For international call access codes for major countries and universal number international prefix, refer to DOCOMO International Services website.

● If you lose your FOMA terminal or have it stolen, immediately take the steps necessary for suspending the use of the FOMA terminal.

● If the FOMA terminal you purchased is damaged, bring your FOMA terminal to a repair counter specified by DOCOMO after returning to Japan.



Don't forget your mobile phone ... or your manners!

When using your mobile phone in a public place, don't forget to show common courtesy and consideration for others around you.



To prevent damage to the environment, bring used battery packs to a docomo service counter, a docomo agent or a recycle center.

Li-ion 00

Repairs

■ From DOCOMO mobile phones (In Japanese only)

☎ (No prefix) 113 (toll free)

* Unavailable from land-line phones, etc.

■ From land-line phones (In Japanese only)

☎ 0120-800-000 (toll free)

* Unavailable from part of IP phones.

(Business hours : 24 hours (open all year round))

Failures encountered overseas
<Network Support and Operation Center>

(available 24 hours a day)

■ From DOCOMO mobile phones

**International call access code
for the country you stay**

-81-3-6718-1414* (toll free)

* You are charged a call fee to Japan when calling from a land-line phone, etc.

※ If you use F-06D, you should dial the number +81-3-6718-1414 (to enter '+', press and hold the '0' key for at least one second).

■ From land-line phones <Universal number>

**Universal number
international prefix**

-8005931-8600*

* You might be charged a domestic call fee according to the call rate for the country you stay.

※ For international call access codes for major countries and universal number international prefix, refer to DOCOMO International Services website.

Sales: NTT DOCOMO, INC.
Manufacturer: FUJITSU LIMITED

2011.11 (1st Edition)
CA92002-7702

Manual for PC Connection

Data Communication	1
Before use	2
Flow of setup for data transfer (OBEX™ communication)	4
Flow of setup for data communication	4
Connecting up PC to the FOMA terminal	5
Installing FOMA communication configuration file (driver)	6
Preparing for Bluetooth® connection	8
Using DOCOMO Connection Manager	9
Setting communications without using DOCOMO Connection Manager	15
Connecting to a Wi-Fi compatible PC	25
AT command	26

About Manual for PC Connection

This manual describes about data communications using the FOMA terminal and how to install "FOMA communication configuration file" and "DOCOMO Connection Manager".

Depending on the environment of your PC, some of operation procedures and/or screens may be different.

- This manual takes FOMA F-02D as an example, for illustrations and screen shots.
- Driver name and modem name are described as "F02D", which vary by model.
- Illustrations used in this manual are examples. The actual shape, etc. may vary by model.
- Description of Bluetooth and Wi-Fi connection is only for compatible models.

Data Communication

There are 3 communication modes available by connecting FOMA terminal and a PC : data transfer (OBEX™ communication), packet communication and 64K data communication.

- To make packet communications or 64K data communications or edit data such as the phonebook using a PC connected, downloading the software from NTT DOCOMO website, installation and various settings are required.
- When performing packet communication overseas, use IP connection (packet communication is unavailable with PPP connection). 64K data communication cannot be used overseas.
- FOMA terminal does not support FAX communication or Remote Wakeup.
- Data communication can be performed connecting with DOCOMO's PDA like sigmarion III. However, FOMA terminal does not support high-speed communication compatible with HIGH-SPEED area.

❖ Data transfer (OBEX™ communication)

You can send and receive data such as image, music, phonebook or mail etc. to/from other FOMA terminals or PCs etc.

- Transferable data varies depending on transfer method. For data that can be transferred by each transfer method, see "Instruction manual (detailed version) (in Japanese only)" (in pdf format) of the FOMA terminal.

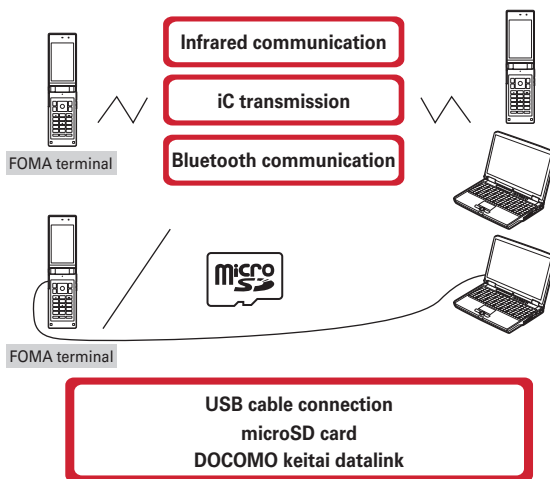

❖ Packet communication

You can connect to the Internet and perform data communication (packet communication). Packet communication charges are based on the amount of data sent and received. No communication charges are required when no data are exchanged even if you are connected to the network. Therefore, sending/receiving data as needed while remaining connected to the network is possible. High-speed packet communication can be performed at a maximum reception speed of 7.2Mbps and a maximum transmission speed of 5.7Mbps by using access points that support FOMA packet communication such as mopera U of DOCOMO's Internet connection service. Best effort method which the actual communication speed varies with the environment and the rate of congestion offers. Note that communications of large-size data such as viewing websites containing images and downloading will require high charges.

- * The communication speed may be slower when connecting out of FOMA HIGH-SPEED area, connecting to access points incompatible with HIGH-SPEED, or using devices incompatible with HIGH-SPEED such as DOCOMO's PDA; sigmarion III.
- * For Bluetooth connection, though the communication speed of FOMA terminal is equal to HIGH-SPEED, communication may not be performed by maximum speed because the communication speed between Bluetooth devices has limits.
- * Maximum speed of reception 7.2Mbps and transmission 5.7Mbps are the values in technical standards, thus they are not indicated actual communication speed. Actual communication speed varies by the network congestion or environment of communication.

❖ 64K data communication

You can connect to the Internet and perform 64K data communication.

Communication charges are based on the duration of the connection to the network regardless of the volume of data. Access points that support FOMA 64K data communication services such as mopera U of DOCOMO's Internet connection service or ISDN synchronized 64K access points can be used.

Please be careful that a high cost will be charged for long-time communications.

Before use

◆ Operating environment

The operation environment for using data communication is as shown below. They may vary depending on the PC system configurations.

Item	Requirements
Computer	PC/AT compatible computer For USB cable connection : USB port (conform to USB specification 1.1/2.0) For Bluetooth connection : Compatible with up to Bluetooth Standard Ver. 2.1 + EDR (dialup networking profiles) supporting dialup networking profile For Wi-Fi connection : Compatible with Wireless LAN Standard IEEE 802.11b, IEEE 802.11g or IEEE 802.11n Recommended 800×600 dots or more in display resolution and High Color 16 bits or more (1,024×600 dots or more (Recommended 1,024 ×768 dots or more))*
OS (Japanese version)	Windows XP, Windows Vista, Windows 7
Memory requirements	Windows XP : 128MB or more Windows Vista : 512MB or more Windows 7 : 1GB or more for 32-bit, 2GB or more for 64-bit
Hard disk capacity	5MB (10MB*) or more free disk space
Web browser*	Internet Explorer 6.0 or more
Mailer software*	Windows Mail and Outlook Express 6.0

* For operating environment of using DOCOMO Connection Manager.

- For the latest information about operating environment, refer to NTT DOCOMO website.
- DOCOMO will not guarantee operations on upgraded OS or added/changed operating environment.
- Note that utilization may not be possible in certain operating environments. DOCOMO assumes no responsibility for pertaining to operation under conditions other than that described above.

◆ Devices required

For USB cable connection, the following devices and software are required in addition to FOMA terminal and a PC.

- FOMA USB Cable with Charge Function 02 (optional) or FOMA USB Cable (optional)
- FOMA communication configuration file (driver)*

* Download from NTT DOCOMO website.

✓ INFORMATION

- USB cable for PC is not available because the connector type is different.
- When using USB HUB, it may not operate properly.

◆ Usage precautions

❖ Internet service provider usage charges

When using the Internet on a PC, usage charge to your Internet service provider (hereinafter referred to as Provider) is required. This charge is paid directly to the Provider, and is separated from the FOMA service charge. For details, contact your Provider.

- DOCOMO's Internet connection service mopera U is available. mopera U is a charged service requiring subscription.

❖ Dialup connection (Provider etc.)

Different dialup connections are required for packet communication and 64K data communication. When performing packet communication, use the dialup connection for packet communication. When performing 64K data communication, use the dialup connection for FOMA 64K data communication or ISDN synchronized 64K data communication.

- Connections to DoPa access points are unavailable.

❖ User authentication

Some dialup connections require user authentication before a connection can be established. If user authentication is required, you must use your communication software or dialup network to enter your ID and password and connect. Your ID and password will be assigned by the network administrator of the connection destination such as your provider or corporate LAN. For details, contact your provider or network administrator.

❖ Access authentication during using PC browser

If FirstPass (user certificate) is required for the access authentication while using PC browser, use FirstPass PC software. Download FirstPass PC software from NTT DOCOMO website, install, and make required settings. For details, refer to DOCOMO website.

❖ Conditions of packet communication and 64K data communication

To perform data communication in Japan, the following conditions must be satisfied.

- You must be within the FOMA service area.
- Packet communication requires an access point that supports FOMA packet communications.
- 64K data communication requires a dialup connection that supports FOMA 64K data communications or ISDN synchronized 64K.
- For Bluetooth connection, a PC requires compatible with up to Bluetooth Standard Ver. 2.1 + EDR (dialup networking profiles) supporting dialup networking profile.
- Wi-Fi connection requires a PC compatible with Wireless LAN Standard IEEE 802.11b, IEEE 802.11g or IEEE 802.11n.

* Note that even when the above requirements are satisfied, you may not be able to perform data communication if base station traffic is heavy or the radio wave conditions are poor.

◆ Introduction of DOCOMO keitai datalink

DOCOMO keitai datalink is software to back up and edit your phone information such as phonebook and mail. It is provided on NTT DOCOMO website. For details and download of this software, refer to the following website.

<http://datalink.nttdocomo.co.jp/>

- To use DOCOMO keitai datalink, installing FOMA communication configuration file (driver) in advance is required.
- For details of downloading procedure, data that can be transferred, operating environments, installing procedure, operation procedure, etc., refer to the website above. For operations after installation, see Help in the software.
- To use DOCOMO keitai datalink, USB cable is required.

Flow of setup for data transfer (OBEX™ communication)

When using USB Cable, install FOMA communication configuration file (driver) in advance.

Downloading FOMA communication configuration file (driver) from NTT DOCOMO website and installing

Data transfer

Flow of setup for data communication

This section describes the setup work for performing packet communication or 64K data communication.

For USB cable connection

- ① Downloading FOMA communication configuration file (driver) from NTT DOCOMO website and installing→P6
- ② Connecting FOMA terminal to a PC→P5
- ③ Confirming FOMA communication configuration file (driver)→P7

For Bluetooth connection

- ① Preparing for Bluetooth connection→P8
- ② Checking modem→P9

Downloading DOCOMO Connection Manager from NTT DOCOMO website and installing→P11

Setting data communication by DOCOMO Connection Manager

Setting communications without using DOCOMO Connection Manager→P15

Performing communication

Wi-Fi connection (packet communication only)

Setting the FOMA terminal to the AP mode

- For AP mode, see "Instruction manual (detail version) (In Japanese only)" (PDF file) of the FOMA terminal.



Setting the connection→P25



Performing communication

◆ Precautions for installation/uninstallation

- Before starting operation, make sure that no other program is running and exit the program if any.
- * Exit any resident programs on Windows including antivirus software.
Example : Right-click the icon displayed in the task bar, click "閉じる (Close)" or "終了 (End)".
- For installing/uninstalling FOMA communication configuration file (driver) or DOCOMO Connection Manager, make sure that a user with administrator's privilege performs the operation. Installing/uninstalling the software by other users may produce an error. For details on PC administrator privileges, refer to the PC manual or contact your PC manufacturer or Microsoft Corporation.
- When "ユーザーアカウント制御 (User account control)" screen is appeared, perform the following operations (it does not appear on Windows XP).
 - Windows 7 : Click "はい (Yes)", or enter password and click "OK".
 - Windows Vista : Click "許可 (Permit)" or "続行 (Continue)", or enter password and click "OK".

Connecting up PC to the FOMA terminal

Connecting/disconnecting to PC is explained here. Installing FOMA communication configuration file (driver) is described separately. →P6

- If you connect FOMA terminal to a PC before installing FOMA communication configuration file (driver), Windows may automatically detect that USB cable has been inserted, and may request the driver. In such a case, click "キャンセル (Cancel)" on the displayed screen to end.
- The connection should be made with a PC and FOMA terminal both turned ON.
- Location of external connection jack or connecting/disconnecting to a USB cable may vary depending on the model. Refer to "Instruction manual (detailed version) (in Japanese only)" (in pdf format) of your FOMA terminal.

◆ Inserting USB cable

- 1** Insert the connector of the USB cable into FOMA terminal's external connection jack horizontally.
- 2** Insert the other end of the USB cable connector into the PC USB port.
 - When a PC and FOMA terminal are connected,  appears on the stand-by display of FOMA terminal.

❖ Removing USB cable

- 1** Press the USB cable's release buttons on both sides of the connector and remove the connector from FOMA terminal horizontally.
- 2** Remove the USB cable out from the PC.

✓ INFORMATION

- Be careful not to give excessive force to the connector of the USB cable when connecting/disconnecting the cable to/from FOMA terminal.
When disconnecting the connector, be sure to pull it straight while pressing the release button. Applying an excessive force to disconnect the connector may give damage to it.
- Do not remove the USB cable during data communication. The data communication is disconnected and it may cause data loss or malfunction.

Installing FOMA communication configuration file (driver)

To make data communication by connecting FOMA terminal and a PC with USB cable, FOMA communication configuration file (driver) is required. Install the file before connecting FOMA terminal for the first time to the PC.

- Before operating, refer to "Precautions for installation/uninstallation".→P5
- For without using USB cable, installing FOMA communication configuration file (driver) is not required.
- Do not connect FOMA terminal until a message that instructs you to connect FOMA terminal to a PC appears in Step 5.

- 1** Download FOMA communication configuration file (driver) from NTT DOCOMO website and decompress.
http://www.nttdocomo.co.jp/support/utilization/application/foma/com_set/driver/index.html
 - Before downloading, check model name of FOMA terminal.
- 2** Double-click the decompressed file→Select a file which your PC is applied to.
 - Select "f-02d_driver_32" for 32-bit OS, or select "f-02d_driver_64" for 64-bit OS.
- 3** In the window displayed, double-click the "F02Dst.exe" icon.
- 4** Click "インストール開始 (Start installation)".
- 5** When a message indicating to connect FOMA terminal to the PC appears, connect FOMA terminal to the PC.
 - Connect FOMA terminal while the power is ON.
- 6** On the Installation completion screen, click "OK".

◆ Confirming FOMA communication configuration file (driver)

- When a PC does not detect FOMA terminal correctly, settings and communication cannot be performed.

<Example> Checking on Windows 7

1  (Start) → "コントロールパネル (Control panel)" → "システムとセキュリティ (System and security)" → "デバイスマネージャー (Device manager)" in the "システム (System)" category.

Under Windows Vista

Click  (Start) → "コントロールパネル (Control panel)" → "システムとメンテナンス (System and maintenance)" → "デバイスマネージャ (Device manager)".

Under Windows XP

① Click "スタート (Start)" → "コントロールパネル (Control panel)" → "パフォーマンスとメンテナンス (Performance and maintenance)" → "システム (System)".

② On the "システムのプロパティ (Property of system)" screen, click "ハードウェア (Hardware)" tab → "デバイスマネージャ (Device manager)".

2 Double-click the type of each device → Confirm that the name of the following devices are registered.

- Device types and names are shown as below.
The order to be displayed differs depending on OSs.

-ポート (COMとLPT) (Port (COM and LPT)) :
FOMA F02D Command Port (COMx)*
FOMA F02D OBEX Port (COMx)*

-モデム (Modem) : FOMA F02D

-ユニバーサルシリアルバスコントローラー
(Universal Serial Bus Controller) or USB
(Universal Serial Bus) コントローラ (Controller)
: FOMA F02D

* Depending on the PC environment, x
represents different numbers.

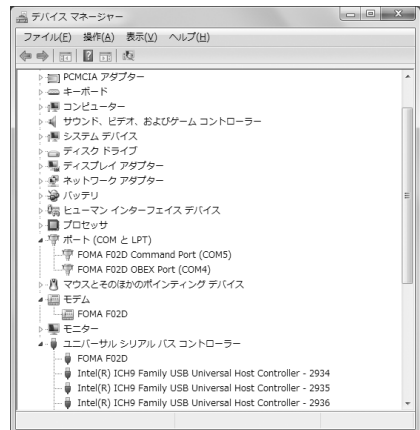

◆ Uninstalling FOMA communication configuration file (driver)

- Before operating, refer to "Precautions for installation/uninstallation". → P5
- Before operating, remove FOMA terminal from the PC.

<Example> Uninstalling the driver under Windows 7, Windows Vista

1 Click  (Start) → "コントロールパネル (Control panel)" → "プログラムのアンインストール (Uninstall programs)" in the "プログラム (Programs)" category.

Under Windows XP

Click "スタート (Start)" → "コントロールパネル (Control panel)" → "プログラムの追加と削除 (Add/delete Programs)".

2 Select "FOMA F02D USB Driver" and click "アンインストールと変更 (Uninstall and change)" (for Windows XP, "変更と削除 (Change and delete)").

3 Confirm that "FOMA F02D Uninstaller" is displayed and click "はい (Yes)".
The uninstall process starts.



4 If the "ドライバを削除しました (Driver deleted)" screen appears, click "OK".

✓INFORMATION

- When "FOMA F02D USB Driver" is not displayed on the deletion screen, execute the operations in "Installing FOMA communication configuration file (driver)" again and uninstall. →P6

Preparing for Bluetooth® connection

You can make data communication by connecting a PC compatible with Bluetooth and FOMA terminal using Bluetooth.

- For operations of a PC, refer to the instructions manual of the PC you use.
- If the FOMA terminal is put on Bluetooth connection standby,  (blue) appears on the stand-by display. If the FOMA terminal and a PC are successfully connected in Bluetooth,  (blue) blinks.

◆ Registering a PC to the FOMA terminal

Register a PC for connecting to FOMA terminal with Bluetooth connection for the first time.

- Depending on the PC environment, Bluetooth passkey may be required.

1 On the FOMA terminal, → "Tool" → "Bluetooth" → "Accept registered"

The FOMA terminal starts the registration waiting and returns to the stand-by display.

2 On a PC, search for the FOMA terminal and register a device.

- Perform while the FOMA terminal is in the registration waiting.
- By some PC instruction manual, "探索 (Quest)" or "サーチ (Search)" may be used instead of "検索 (Retrieve)", or "ペアリング (Pairing)" may be used instead of "機器登録 (Registering device)".

3 When a pass key authentication screen appears, select "はい (Yes)".

- Select "はい (Yes)" when the connection confirmation screen is displayed.
- After the PC is registered as a device and the registration is completed, the FOMA terminal returns to the stand-by display in the registration waiting state. Perform settings/operations on the PC as required.

For entering Bluetooth passkey

Enter Bluetooth pass key (one-byte number 4 - 16 digit)  [OK]

- Enter the same Bluetooth passkey on FOMA terminal and a PC.
- When a confirmation screen of the default connection device (audio) setting appears, select "No".

✓INFORMATION

- When registering FOMA terminal in a PC, distinguish FOMA terminal by the name of device if the PC recognizes plural devices. When the PC recognizes many devices of the same name, distinguish by the address of device.

◆ Connecting to a registered PC

When connecting a registered PC to FOMA terminal using Bluetooth, set the FOMA terminal in connecting stand-by.

1 On the FOMA terminal, → "Tool" → "Bluetooth"

2 Move the cursor to "Accept registered" → [Type] → Mark "Dial-up(DUN)" to → [Confrm].

The FOMA terminal starts the registration waiting and returns to the stand-by display.

- When other Bluetooth device is connected, a confirmation screen for asking whether to disconnect the device in connection and start the registration waiting.

3 Operate for connecting on the PC.

◆ Checking modem

Confirm the name of modem used on a PC or COM port number set for dialup connection.

- When a PC does not detect FOMA terminal correctly, settings and communication cannot be performed.

<Example> Checking on Windows 7

1 Click  (Start) → "コントロールパネル (Control panel)" → "システムとセキュリティ (System and security)" → "デバイスマネージャー (Device manager)" in the "システム (System)" category.

Under Windows Vista

Click  (Start) → "コントロールパネル (Control panel)" → "システムとメンテナンス (System and maintenance)" → "デバイスマネージャ (Device manager)".

Under Windows XP

① Click "スタート (Start)" → "コントロールパネル (Control panel)" → "パフォーマンスとメンテナンス (Performance and maintenance)" → "システム (System)".

② On the "システムのプロパティ (Property of system)" screen, click "ハードウェア (Hardware)" tab → "デバイスマネージャ (Device manager)".

2 Double-click the type of each device → Confirm the modem name or COM port number.

- Modem name or COM port number is shown under "モデム (Modem)", "ポート (COMとLPT) (Port (COM and LPT))".

Using DOCOMO Connection Manager

DOCOMO Connection Manager is convenient software to use flat-rate data communication or pay-as-you-go data communication. You can easily subscribe to mopera U and make a PC setting according to your subscription status.

Also, you can check an estimate of data communication volume or usage fees by the charge counter function.

In this manual, the method of installing DOCOMO Connection Manager is explained.

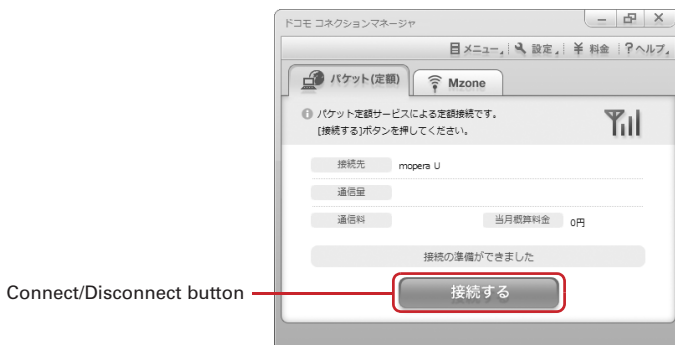

- For Internet connection with FOMA terminal, you need to subscribe to flat-rate data plan or FOMA service and Internet service provider (mopera U etc.) applicable to data communication. For details, refer to DOCOMO website.

✓INFORMATION

Using pay-as-you-go data communication

- Note that communications of large-size data such as viewing websites containing images using packet communication and downloading (example: applications, music/video data, update data of OS or anti-virus software) will require high charges.
Note that FOMA flat-rate packet services such as Pake-hodai and Pake-hodai full are not applied to the data communication by connecting the FOMA terminal to a PC or another device with a USB cable.

◆ Before installing DOCOMO Connection Manager

Before installing DOCOMO Connection Manager, check the items below and perform to change setting of software/uninstall as required.

- Prepare FOMA terminal and FOMA USB Cable with Charge Function 02 (optional) (For Bluetooth connection, USB cable is not required).
- Check the contents of subscription for charging plan/discount service and Internet service provider.
- If installing connection software except for DOCOMO Connection Manager, change the setting not to be activated automatically as required. →P11 "Using connection software except for DOCOMO Connection Manager"

❖ Changing setting of Internet Explorer

- Before installing DOCOMO Connection Manager, set to "ダイヤルしない (No dialing)" for connection setting at "インターネットオプション (Internet option)" field of Internet Explorer in advance.

<Example> Changing under Windows 7, Windows Vista

- 1 Click  (Start) → "すべてのプログラム (All programs)" → "Internet Explorer".
Under Windows XP
Click "スタート (Start)" → Select "すべてのプログラム (All programs)" → Click "Internet Explorer".
- 2 Click "ツール (Tool)" → "インターネットオプション (Internet option)".
- 3 Click "接続 (Connection)" tab → Select "ダイヤルしない (No dialing)".



- 4 Click "OK".

❖ Using connection software except for DOCOMO Connection Manager

DOCOMO Connection Manager includes same function as that of software below and using together is not required. Perform to change setting not to be activated or uninstall as required.

- mopera U start up tool
- mopera U connection & setting tool
- FOMA PC configuration software
- FOMA Byte counter

To use Mzone (docomo Public wireless LAN service) by DOCOMO Connection Manager, uninstall the following public wireless LAN connection software. And, when installing all at once, Mzone connection cannot be used by DOCOMO Connection Manager.

- U公衆無線LANユーティリティソフト (U public wireless LAN utility software)
- ドコモ公衆無線LANユーティリティソフト (DOCOMO public wireless LAN utility software)
- ドコモ公衆無線LANユーティリティプログラム (DOCOMO public wireless LAN utility program)

◆ Installing DOCOMO Connection Manager

- Before operating, refer to "Precautions for installation/uninstallation". →P5

<Example> Installing under Windows 7

1 Access DOCOMO Connection Manager web page from NTT DOCOMO website.

http://www.nttdocomo.co.jp/support/utilization/application/service/connection_manager/

2 Click "ドコモ コネクションマネージャ (Windows®用) へ (DOCOMO Connection Manager (For Windows®))".

3 Click " [ドコモ コネクションマネージャ (Windows®用)] ダウンロードへ (Download [DOCOMO Connection Manager (For Windows®)])".

4 Read the 使用許諾契約書 (terms of use) and click "同意する (Agree)" under ダウンロード (Download) if you agree.

5 Double-click the "dcm_connect_mng_setup.exe" icon.

6 Click "次へ (Next)".

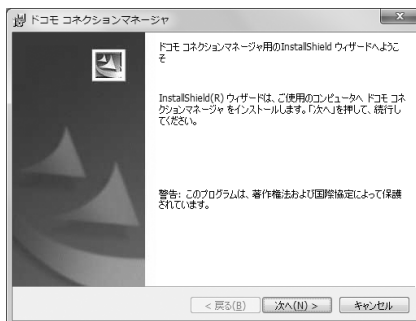

7 Confirm "注意事項 (Precautions)" and click "次へ (Next)".

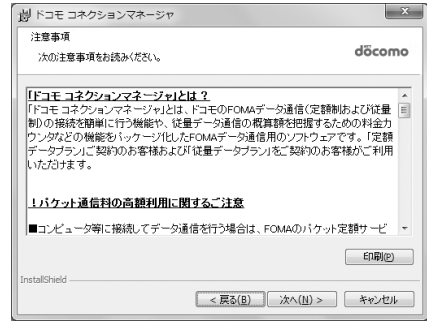

8 Confirm the contents of ソフトウェア使用許諾契約 (Software license agreement) and if you agree to the agreement, select "使用許諾契約の条項に同意します (Agree to the clauses of the agreement)" and click "次へ (Next)".

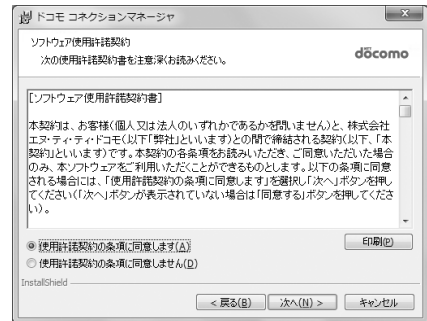

9 Confirm the installing folder and click "次へ (Next)".

- To change the installation destination, click "変更 (Change)" and specify any installation destination.

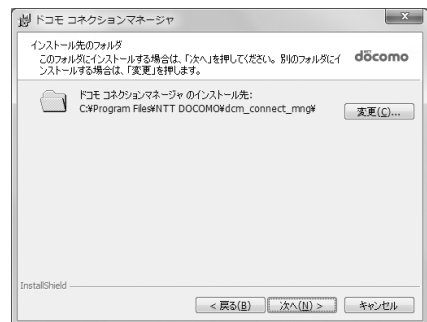

10 Click "インストール (Install)".

Installation starts.

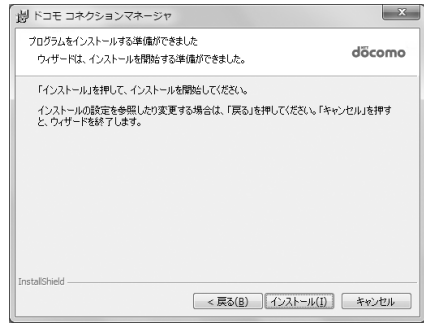

11 When the "InstallShieldウィザードを完了しました (InstallShield wizard is completed)" screen appears, click "完了 (Done)".

Installing DOCOMO Connection Manager is completed.



✓INFORMATION

- Installation may take a few minutes.
- When a message notifying you to reboot Windows is displayed, follow the instruction of screen and reboot.
- Do not install during data communication.

◆ Starting DOCOMO Connection Manager

- Before operating, make sure that a PC and FOMA terminal are properly connected.

<Example> Setting under Windows 7, Windows Vista

1 Click  (Start) → "すべてのプログラム (All Programs)" → "NTT DOCOMO" → "ドコモ コネクションマネージャ (DOCOMO Connection Manager)" → "ドコモ コネクションマネージャ (DOCOMO Connection Manager)".

Under Windows XP

Click "スタート (Start)" → Select "すべてのプログラム (All programs)" → "NTT DOCOMO" → "ドコモ コネクションマネージャ (DOCOMO Connection Manager)" and click "ドコモ コネクションマネージャ (DOCOMO Connection Manager)".

DOCOMO Connection Manager starts.

When booting a PC at first time, the setting wizard screen appears automatically.



- According to the setting wizard, perform to set for making data communication connecting to Internet.
After setting, you can perform communication using DOCOMO Connection Manager.
For details, refer to Help of DOCOMO Connection Manager.

✓ INFORMATION

- Just exiting the Internet browser or mail software may not disconnect communication. When you do not use communication, be sure to disconnect the communication from "切断する (Disconnect)" button of DOCOMO Connection Manager.
- Please note that if auto update is set for OS update etc., the software is updated automatically and high cost may be charged for the packet communication fee.

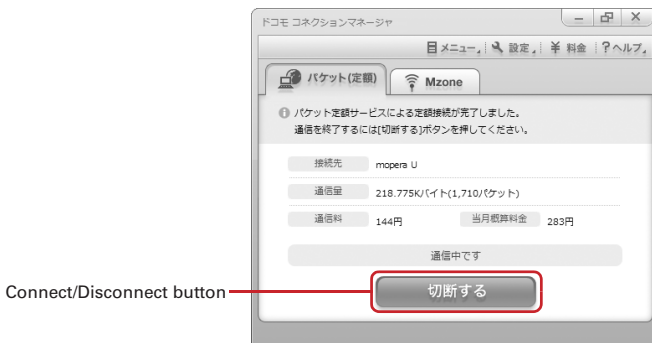

Setting communications without using DOCOMO Connection Manager

The method of dialup connection setup without DOCOMO Connection Manager is explained.

◆ Flow of dialup network setting

- Flow of setup for data communication→P4
- Before operating, make sure that a PC and FOMA terminal are properly connected.

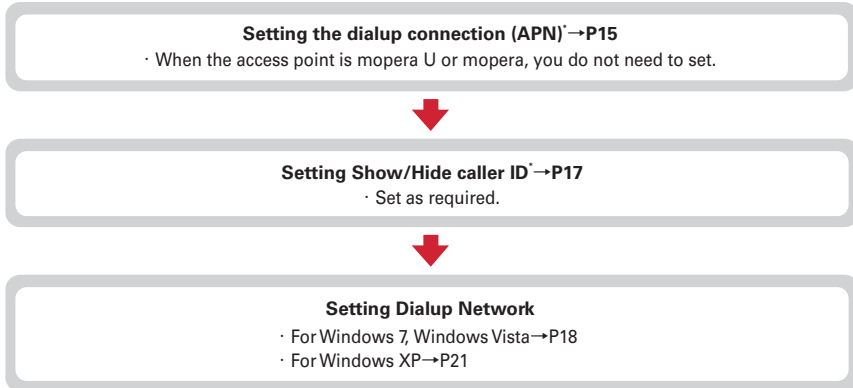

* Set for packet communication.

Communication software to input AT commands is required for settings.

The method of setting using "ハイパーターミナル (Hyper terminal)" that comes with Windows XP is explained here. Windows 7 and Windows Vista do not support "ハイパーターミナル (Hyper terminal)". For Windows 7 and Windows Vista, set using the software supported by Each OS (Follow the method for the software to be used.).

◆ Setting the dialup connection (APN)

❖ The dialup connection (APN) and registration number (cid)

The dialup connections (APN) for packet communication can be set for registration numbers (cid) between 1 and 10 in FOMA terminal. By default, "mopera.ne.jp" (APN) to connect to mopera is registered in cid1, "mopera.net" (APN) to connect to mopera U is registered in cid2 and 3, and "mpr.ex-pkt.net" (APN) to connect in 128K communication is registered in cid4. For connecting to other providers or corporate LANs, register APN for cid5-10.

- For the dialup connections (APN), inquire your provider or network administrator.
- For USB cable connection and Bluetooth connection, setting each dialup connections (APN) is required.
- For packet communication, if switching between USB cable connection and Bluetooth connection, setting the dialup connections (APN) is required again.
- The dialup connection settings can be considered as phonebook entries registered for packet communication. The comparison between dialup connection settings and FOMA terminal phonebook is as shown below.

Connection (APN)	Phonebook item
Registration number (cid)	Registration number (Phonebook No.)
Connection name (APN)	Party's name
*99** * <cid># (packet communication)	Party's phone number

- The registered cid become the connection number in the dialup connection numbers setting.

❖ Setting the dialup connection (APN)

<Example> Setting under Windows XP

1 Click "スタート (Start)" → Select "すべてのプログラム (All programs)" → "アクセサリ (Accessories)" → "通信 (Communication)" and click "ハイパーターミナル (Hyper terminal)".

2 Enter the desired dialup connection name in "名前 (Name)" → Click "OK".

- The following characters (one-byte) cannot be used in "名前 (Name)".
¥/:*?<>|"



3 Enter a fictional phone number (such as "0") for "電話番号 (Phone number)" → Select "接続方法 (Connection method)" → Click "OK".

- "市外局番 (Area code)" differs depending on the PC environment. The code does not relate to Dialup connection (APN) setup. So no need to change.
- Set as follows at "接続方法 (Connection method)" field.
For USB cable connection : Select "FOMA F02D".
For Bluetooth connection : Select "ご使用の Bluetoothリンク経由標準モデム (Standard modem via Bluetooth link you use)" or "Bluetooth機器メーカーが提供している Bluetooth モデム (Bluetooth modem provided by Bluetooth device manufacturer)".

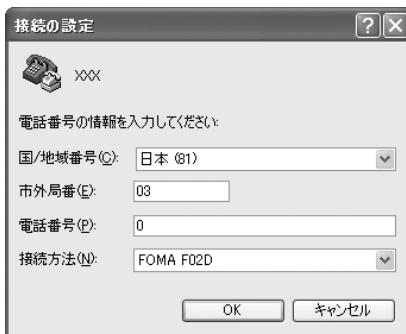

4 Click "キャンセル (Cancel)" on the "接続 (Connect)" screen.

5 Enter the dialup connection (APN) in the format "AT+CGDCONT =<cid>, "<PDP_TYPE>","<APN>" →

<cid> : Enter any number between 5-10.

<PDP_TYPE> : IP or PPP

<APN> : Dialup connection (APN)

- +CGDCONT command → P33 "Supplement to AT command"
- If nothing is displayed even when AT command is entered, enter ATE1 and press .

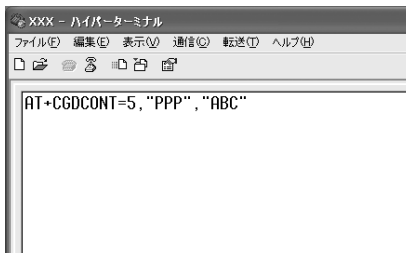

6 Confirm that "OK" is displayed and click "ファイル (File)"→Click "ハイパーターミナルの終了 (End HyperTerminal)".

7 When confirming disconnection, click "はい (Yes)"→When confirming saving, click "いいえ (No)".

◆ Setting Show/Hide caller ID

You can set to show/hide call ID for packet communication at once.

Caller ID is your important information. Take care when deciding to disclose your caller ID.

- If "Not notify" is set when using moper a U or moper a, connection is unavailable.

<Example> Setting under Windows XP

1 Perform Step 1 - 4 in "Setting the dialup connection (APN)".

2 Enter notify/not notify of caller ID in the format "AT *DGPIR=<n>"→.

<n> : 0-2

0 : Connect directly (Default)

1 : Connect prefixing 184 (Not notify)

2 : Connect prefixing 186 (Notify)

- If nothing is displayed even when AT command is entered, enter ATE1 and press .

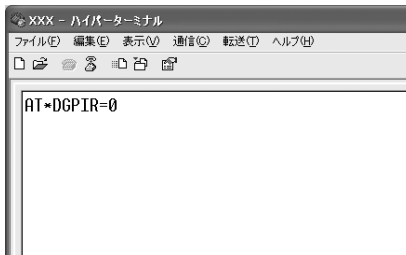

3 Confirm that "OK" is displayed and click "ファイル (File)"→Click "ハイパーターミナルの終了 (End HyperTerminal)".

4 When confirming disconnection, click "はい (Yes)"→When confirming saving, click "いいえ (No)".

❖ Show/Hide caller ID function by dialup network settings

The dialup network settings can also be used to append 186 (Notify)/184 (Not notify) to the dialup connection number.

- The Show/Hide of caller ID when both of the *DGPIR command and dialup network settings are set is as shown below.

Setting made by *DGPIR command \ Dialup network setting (<cid>=3)	No setting	Caller ID is not sent	Caller ID is sent
99 **3#	Caller ID is sent	Caller ID is not sent	Caller ID is sent
184*99* **3#	Caller ID is not sent		
186*99* **3#	Caller ID is sent		

◆ Setting dialup network

In this manual, the description takes the case of IP connection to mopera U via packet communication for example.

- When connecting to mopera U or mopera via packet communication, enter the following number in the phone number field.
mopera U (PPP connection) : * 99 * * * 2#
mopera U (IP connection) : * 99 * * * 3#
128K communication (PPP connection) : * 99 * * * 4#
mopera (PPP connection) : * 99 * * * 1#
- When connecting to mopera U or mopera via 64K data communication, enter the following number in the phone number field to connect to.
mopera U : * 8701
mopera : * 9601

❖ Setting for Windows 7, Windows Vista

- 1** Click  (Start) → "コントロールパネル (Control panel)" → "ネットワークの状態とタスクの表示 (Network status and tasks)" in the "ネットワークとインターネット (Network and Internet)" category.

Under Windows Vista

Click  (Start) → "接続先 (Dialup connection)".

- 2** Click "新しい接続またはネットワークのセットアップ (Setup new connection or network)".

Under Windows Vista

Click "接続またはネットワークをセットアップします (Set up connection or network)".

- 3** Select "ダイヤルアップ接続をセットアップします (Set up dialup connection)" and click "次へ (Next)".



When the "どのモデムを使いますか？ (Which modem will you use?)" screen is displayed

For USB cable connection : Click "FOMA F02D".

For Bluetooth connection : Click "ご使用のBluetoothリンク経由標準モデム (Standard modem via Bluetooth link you use)" or "Bluetooth機器メーカーが提供しているBluetoothモデム (Bluetooth modem provided by Bluetooth device manufacturer)".

- 4** Enter the phone number of the dialup connection in "ダイヤルアップの電話番号 (Dialup phone number)" ("*99**<cid>#" for packet communication) with one-byte→Enter "ユーザー名 (User name)"→Enter "パスワード (Password)"→Enter "接続名 (Connection name)" and click "接続 (Connect)".

<cid> : The number registered in P16 "Setting the dialup connection (APN)"

- In "ユーザー名 (User name)" and "パスワード (Password)", enter the user name and password specified by your provider or network administrator.
- When the access point is mopera U or mopera, you do not need to enter "ユーザー名 (User name)" or "パスワード (Password)".
- You cannot use "." (one-byte period) at the beginning of "接続名 (Connection name)". Also, the following characters (one-byte) cannot be used.

¥/:*?<>|"

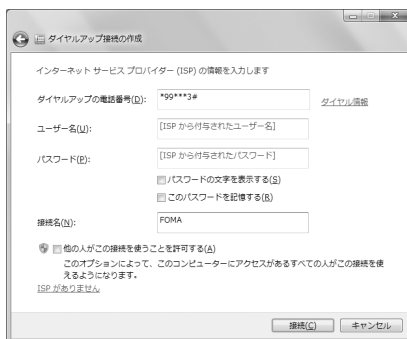

- 5** On the connecting screen, click "スキップ (Skip)".

- Only make settings without connecting to the Internet right away.

- 6** On the "接続の使用準備ができました (Preparation for using is completed)" screen, click "閉じる (Close)".

Under Windows Vista

- ① On the "インターネット接続テストに失敗しました (Failed in Internet connection test)" screen, click "接続をセットアップします (Set up connection)".
- ② Click "閉じる (Close)".

- 7** On the "ネットワークと共有センター (Network and shared center)" screen, click "アダプターの設定の変更 (Change adapter configuration)" appeared on the left of the top.

Under Windows Vista

Click  (Start)→"接続先 (Dialup connection)".

- 8** Right-click the dialup connection created and click "プロパティ (Property)".

9 Confirm the setting of each item in "全般 (General)" tab.

- When multiple modems are connected to a PC, set as follows.

For USB cable connection : Select only "モデム-FOMA F02D (Modem-FOMA F02D)" at "接続の方法 (Connection method)" field.

For Bluetooth connection : Select "モデム- (ご使用のBluetoothリンク経由標準モデム) (Modem-(Standard modem via Bluetooth link you use))" or "モデム- (Bluetooth機器メーカーが提供しているBluetoothモデム) (Modem- (Bluetooth modem provided by Bluetooth device manufacturer))" at "接続の方法 (Connection method)" field.

- Uncheck () other than selected modem.
- COM port number assigned to the modem displayed at "接続の方法 (Connection method)" field differs by the environment of a PC you use.
- Uncheck () "ダイヤル情報を使う (Use dial information)".

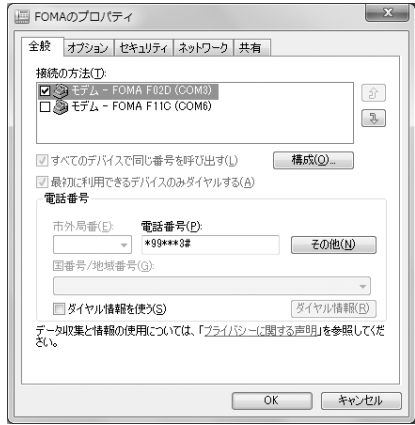

10 Click "ネットワーク (Network)" tab→Set each item as shown below.

- Uncheck () "インターネットプロトコルバージョン6 (TCP/IPv6) (Internet Protocol Version 6 (TCP/IPv6))".
- When settings of IP and DNS information have been requested from the provider, etc. select "インターネットプロトコルバージョン4 (TCP/IPv4) (Internet Protocol Version 4 (TCP/IPv4))", click "プロパティ (Property)" and set various information.
- If settings of other items have been requested from the provider, etc., check/uncheck as required.



11 Click "オプション (Option)" tab→Click "PPP設定 (PPP settings)".

12 Uncheck all items () and click "OK".



13 Click "OK".

Performing communication→P23

- 1 Click "スタート (Start)"→Select "すべてのプログラム (All programs)"→"アクセサリ (Accessories)"→"通信 (Communication)" and click "新しい接続ウィザード (New connection wizard)".
- 2 On the "新しい接続ウィザードの開始 (Start new connection wizard start)" screen, click "次へ (Next)".
- 3 Select "インターネットに接続する (Connect to Internet)" and click "次へ (Next)".
- 4 Select "接続を手動でセットアップする (Set up connection manually)" and click "次へ (Next)".
- 5 Select "ダイヤルアップモデムを使用して接続する (Use dialup modem to connect)" and click "次へ (Next)".

When "デバイスの選択 (Device selection)" screen is displayed

For USB cable connection : Select "モデム-FOMA F02D (Modem-FOMA F02D)" and click "次へ (Next)".

For Bluetooth connection : Select "モデム- (ご使用のBluetoothリンク経由標準モデム) (Modem- (Standard modem via Bluetooth link you use))" or "モデム- (Bluetooth機器メーカーが提供しているBluetoothモデム) (Modem- (Bluetooth modem provided by Bluetooth device manufacturer))" and click "次へ (Next)".

- 6 Enter the desired dialup connection name in "ISP名 (ISP name)" → Click "次へ (Next)".

- You cannot use "." (one-byte period) at the beginning of "ISP名 (ISP name)". Also, the following characters (one-byte) cannot be used.
¥/: * ? <> | "

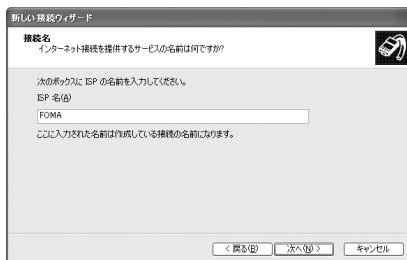

- 7 Enter the phone number of the dialup connection in "電話番号 (Phone number)" (" * 99 * * * <cid>#" for packet communication) with one-byte → Click "次へ (Next)".

<cid> : The number registered in P16 "Setting the dialup connection (APN)"

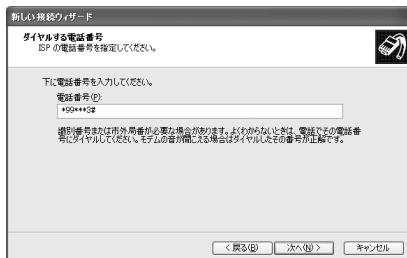

8 Enter "ユーザー名 (User name)"→Enter "パスワード (Password)"→Enter "パスワードの確認入力 (Password confirmation entry)"→Select all items as shown below and click "次へ (Next)".

- In "ユーザー名 (User name)" and "パスワード (Password)", enter the user name and password specified by your provider or network administrator.
- When the access point is mopera U or mopera, you do not need to enter "ユーザー名 (User name)", "パスワード (Password)" or "パスワードの確認入力 (Password confirmation entry)".

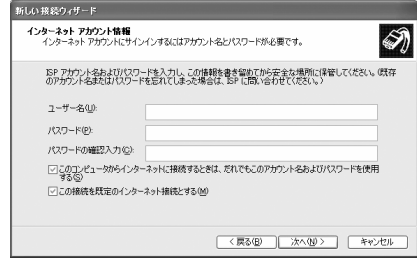

9 On the "新しい接続ウィザードの完了 (New connection wizard is completed)" screen, click "完了 (Done)".

10 Click "スタート (Start)"→Select "すべてのプログラム (All programs)"→"アクセサリ (Accessories)"→"通信 (Communication)" and click "ネットワーク接続 (Network connection)".

11 Select the created dialup connection icon and click "ファイル (File)"→Click "プロパティ (Property)".

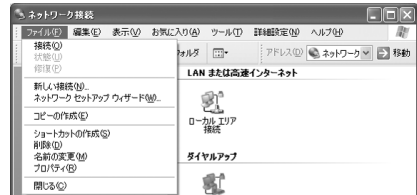

12 Confirm the setting of each item in "全般 (General)" tab.

- When plural modems are connected to a PC, set as follows.

For USB cable connection : Select only "モデム-FOMA F02D (Modem-FOMA F02D)" at "接続方法 (Connection method)" field.

For Bluetooth connection : Select "モデム-(ご使用のBluetoothリンク経由標準モデム) (Modem-(Standard modem via Bluetooth link you use))" or "モデム-(Bluetooth機器メーカーが提供しているBluetoothモデム) (Modem-(Bluetooth modem provided by Bluetooth device manufacturer))" at "接続方法 (Connection method)" field.

- Uncheck other than selected modem.
- COM port number assigned to the modem displayed at "接続方法 (Connection method)" field differs by the environment of a PC you use.
- Uncheck "ダイヤル情報を使う (Use dial information)".



13 Click "ネットワーク (Network)" tab→Set each item as shown below→Click "設定 (Settings)".

- When settings of IP and DNS information have been requested from the provider, etc. select "インターネットプロトコル (TCP/IP) (Internet protocol (TCP/IP))", click "プロパティ (Property)" and set necessary information.
- Since "QoSパケットスケジューラ (QoS packet scheduler)" settings in "この接続は次の項目を使用します (Q)" can not be changed, leave it as is.



14 Uncheck all items () and click "OK".



15 Click "OK".

Performing communication→P23

◆ Performing communication via dialup connection

Starting communication and disconnection are explained here.

<Example> Under Windows 7

1 Connect FOMA terminal to a PC.

For USB cable connection→P6

For Bluetooth connection→P8

2 Click (Start)→"コントロールパネル (Control panel)"→"インターネットへの接続 (Connect to the Internet)" in the "ネットワークとインターネット (Network and Internet)" category.

Under Windows Vista

Click  (Start)→"接続先 (Dialup connection)"→Select the dialup connection and click "接続 (Connect)".→Go to Step 4

Under Windows XP

Click "スタート (Start)"→Select "すべてのプログラム (All programs)"→"アクセサリ (Accessories)"→"通信 (Communication)" and click "ネットワーク接続 (Network connection)"→Double-click the connection icon.→Go to Step 4

3 Click "はい、既存の接続を選びます (Yes. I select exist connection)"→Select the dialup connection and click "次へ (Next)".

4 Enter "ユーザー名 (User name)" → Enter "パスワード (Password)" → Click "ダイヤル (Dial)".

- In "ユーザー名 (User name)" and "パスワード (Password)", enter the user name and password specified by your provider or network administrator.
- When using mopera U or mopera, you do not need to enter "ユーザー名 (User name)" or "パスワード (Password)".
- When "ユーザー名 (User name)" was entered or "パスワード (Password)" was saved while settings, these entries are no longer necessary.
- Click "OK" when the connection established screen is displayed.



✓ INFORMATION

- FOMA terminal displays a connecting screen when you execute packet communication or 64K data communication. The following screens are displayed when a connection has been established.

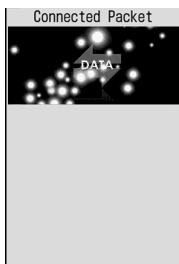

For packet communication

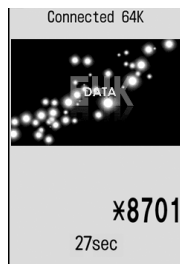

For 64K data communication

- The communication speed displayed on your PC may differ from actual speed.
- The communication is available only with FOMA terminal that was connected when the dialup network was set.

❖ Disconnecting communication

Just exiting the PC browser may not disconnect communication. To ensure disconnection, perform the following operation.

<Example> Under Windows 7

- 1 Click  on the task tray → Connection name to disconnect → "切断 (Disconnect)".

Under Windows Vista

Right-click  in the task tray → Select "切断 (Disconnect)" and click the dialup connection to disconnect.

Under Windows XP

Click dial-up icon in the task tray → Click "切断 (Disconnect)".

Connecting to a Wi-Fi compatible PC

Even out of public wireless LAN area, you can perform packet communication with connecting a Wi-Fi compatible PC to use FOMA terminal as an access point.

- Switch FOMA terminal to AP mode ON in advance. For AP mode settings, refer to "Instruction manual (detailed version) (in Japanese only)" (PDF file) of the FOMA terminal.

<Example> Under Windows 7

1 Click  (Start) → "コントロールパネル (Control panel)" → "ネットワークの状態とタスクの表示 (Network status and tasks)" in the "ネットワークとインターネット (Network and Internet)" category.

Under Windows Vista

Click  (Start) → "接続先 (Dialup connection)".

2 Click "新しい接続またはネットワークのセットアップ (Setup new connection or network)".

Under Windows Vista

Click "接続またはネットワークをセットアップします (Set up connection or network)".

3 Select "ワイヤレスネットワークに手動で接続します (Connect to Wireless network manually)" and click "次へ (Next)".

- To make wireless connection for the first time, on the "ワイヤレスネットワークに手動で接続します (Connect to wireless network manually)" screen, change "ワイヤレスアダプタ (Wireless adapter) to "ワイヤレスネットワーク接続 (Wireless network connection)" and click "次へ (Next)".

4 Enter network information and click "次へ (Next)".

- Set it to the same as "無線設定 (Wireless settings)" of the FOMA terminal.
 - ネットワーク名 (Network name) : Enter the SSID set for the FOMA terminal.
 - セキュリティの種類 (Security type), 暗号化の種類 (Encryption type) : Set "認証方式 (Authentication method)" information in the FOMA terminal. In "認証方式 (Authentication method)", it is described in the format combining "セキュリティの種類 (Security type)" and "暗号化の種類 (Encryption type)" settings. Select a corresponding setting. "パーソナル (Personal)" in "セキュリティの種類 (Security type)" is the same meaning as "PSK".
 - セキュリティキー (Security key) (For Windows Vista, "セキュリティキーまたはパスフレーズ (Security key or pass phrase)" : Enter encryption key (WEP or PSK).

5 Click "閉じる (Close)".

■ To re-execute communication via Wi-Fi connection after disconnection

Under Windows 7

 (Start) → "コントロールパネル (Control panel)" → "ネットワークの状態とタスクの表示 (Network status and tasks)" in the "ネットワークとインターネット (Network and Internet)" category → On the "ネットワークと共有センター (Network and sharing center)" screen, "ネットワークに接続 (Connect to network)" → Click a connection name on the screen → Click "接続 (Connect)".

Under Windows Vista

 (Start) → "接続先 (Connection point)" → Select a connection point and click "接続 (Connect)".

AT command

AT commands are commands for setting FOMA terminal functions using a PC. FOMA terminals comply with AT commands and support some extended commands and proprietary AT commands.

❖ AT command input format

"AT" must be entered before each AT command. Commands must be entered in one-byte alphanumeric characters.

<Example> Connecting to mopera U with ATD command

ATD *99* * *3#

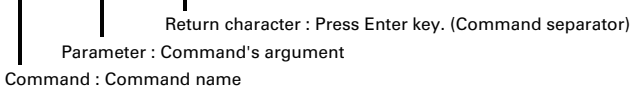

AT commands and their parameters must be entered on a single line. All the characters from the first character until the character directly preceding # must be entered on a single line. Each line can be up to 256 characters including "AT".

❖ AT command input mode

To operate FOMA terminal using AT commands, a PC must be in terminal mode. Terminal mode is a mode that lets the PC operate as a single communication terminal. When terminal mode is set, the characters entered from the keyboard are sent directly to the communication port to operate FOMA terminal.

• Offline mode

FOMA terminal is in stand-by. FOMA terminal must be in stand-by status to use AT commands to control it.

• Online data mode

FOMA terminal is communicating. If you enter AT commands when FOMA terminal is performing communication, the sent characters are sent directly to the communication receiver and may cause the receiver's modem to malfunction. Do not enter AT commands while FOMA terminal is performing communication.

• Online command mode

AT commands can be used even when FOMA terminal is in communication mode. These operations make it possible to execute AT commands without interfering with the connection to the communication receiver, and normal communication can continue after the commands have finished executing.

Switching between online data mode and online command mode

To switch FOMA terminal from online data mode to online command mode, you can use either of the following procedures.

- Enter +++ command or code set in the S2 register.
- Turn the RS-232C[®]ER signal OFF when set in "AT&D1".

* The USB or Bluetooth interface emulates an RS-232C signal line so RS-232C signal control using communication applications is possible.

To switch from online command mode to online data mode, enter "ATO#".

✓ INFORMATION

- When making a call or sending an AT command from external device, it is sent from Number A with 2in1 in Dual mode or A mode, and from Number B in B mode.

◆ List of AT command

- The followings are AT command that can be used via the FOMA F02D (Modem).
- Entering "≠" may cause "\n" to appear depending on the font setting for a PC or communication software.
- If the battery pack is removed from FOMA terminal before the terminal power is turned off, the setting values may not be recorded.

Upper slot : Command Lower slot : Example	Description
A/ A/ OK	Execute the previously executed command again. When previous response is "ERROR", "ERROR" is returned.
AT AT [↵] OK	Use commands on this list by prefixing to commands other than A/ or +++. When using only this command, "OK" is returned with FOMA terminal enabled for using AT commands.
ATA RING ATA [↵] CONNECT	Perform the receiving process when entered while receiving a packet communication or 64K data communication. The following commands can be entered when receiving a packet communication. ATA184 : Handling of incoming calls : Send caller ID function OFF ATA186 : Handling of incoming calls : Send caller ID function ON
ATD ATD *99 * * * 1# [↵] CONNECT 460800	ATD *99 * * * <cid># : Performs calling process for packet communication. If <cid> or * * * <cid> is omitted, <cid>=1 is set. ATD [parameter] [phone number] : Perform calling process for 64K data communication. Calling process is not permitted if phone number contains characters other than the following. 0-9, *, #, A, a, B, b, C, c The following characters and a space can be entered but are not recognized in dialing. ,(comma), !, -, @, D, d, P, p, T, t, W, w Setting Show/Hide caller ID is enabled by inserting 186 or 184 after ATD. ATDN or ATDL can be used for redial calling.
ATE<n>*1 ATE1 [↵] OK	Set whether FOMA terminal will return echo for command sent from a PC. n=0 : Echo OFF n=1 : Echo ON (default) Normal usage is n=1. If the PC has an echo function, setting this command to n=0 prevents double display of characters.
ATH ATH [↵] NO CARRIER	Disconnect line when entered during a communication. Execute in online command mode.→P26
ATI<n> ATI0 [↵] NTT DoCoMo OK	Display the confirmation code. n=0 : "NTT DoCoMo" n=1 : Display model name of FOMA terminal n=2 : Display version of FOMA terminal n=3 : Display elements of ACMP signals n=4 : Display details of functions that can be communicated by FOMA terminal in numeric
ATO ATO [↵] CONNECT 460800	Return from online command mode to online data mode during communication.
ATQ<n>*1 ATQ0 [↵] OK	Set whether to display result code. n=0 : Display (default) n=1 : Not display When ATQ1 is executed, "OK" is not returned.
ATS0=<n>*1 ATS0=0 [↵] OK	Set number of rings until FOMA terminal receives communication automatically. n=0 : Not receive automatically (default) n=1-255 : Receive automatically with specified number of rings ATS0? : Display current settings
ATS2=<n> ATS2=43 [↵] OK	Set escape character. n=0-127 (default : n=43) When n=127 is set, escape is unavailable. ATS2? : Display current settings
ATS3=<n> ATS3=13 [↵] OK	Set the carriage return (CR) character that identifies the end of AT command character string. Appended to end of echoed command character string and result code. n=13 (fixed value) ATS3? : Display current settings

Upper slot : Command Lower slot : Example	Description
ATS4=<n> ATS4=10 [↵] OK	Set the line feed (LF) character. When result code is displayed as alphabetic characters, appends the character after the carriage return (CR) character. n=10 (fixed value) ATS4? : Display current settings
ATS5=<n> ATS5=8 [↵] OK	Set the back space (BS) character. When this character is detected during command input, the last character in the input buffer is deleted. n=8 (fixed value) ATS5? : Display current settings
ATS6=<n> ATS6=5 [↵] OK	Set pause time (seconds) until dialing commences but do not operate. n=2-10 (default : n=5) ATS6? : Display current settings
ATS8=<n> ATS8=3 [↵] OK	Set pause time (seconds) until commas are dialed but do not operate. n=0-255 (default : n=3) ATS8? : Display current settings
ATS10=<n>*1 ATS10=1 [↵] OK	Set the delay time (1/10 seconds) for automatic disconnection but do not operate. n=1-255 (default : n=1) ATS10? : Display current settings
ATS30=<n> ATS30=0 [↵] OK	Set a period of time (minutes) with no data transmission/reception to terminate the connection for 64K data communications. n=0-255 : (default : n=0, n=0 indicates that inactive timer is set to OFF.) ATS30? : Display current settings
ATS103=<n> ATS103=1 [↵] OK	Set the separator of received sub addresses for 64K data communication. n=0 : * n=1 : / (default) n=2 : ¥ or \ ATS103? : Display current settings
ATS104=<n> ATS104=1 [↵] OK	Set the separator of sent sub addresses for 64K data communication. n=0 : # n=1 : % (default) n=2 : & ATS104? : Display current settings
ATV<n>*1 ATV1 [↵] OK	Set result code display method. n=0 : Number display n=1 : Alphabetical display (default) When ATV0 is executed, "0" is not returned to the same line.
ATX<n>*1 ATX4 [↵] OK	Set whether to detect busy or dial tones and whether to display the speed in the "CONNECT" display for the connection. Busy tone detection : Send "BUSY" response when dialup connection is busy. Dial tone detection : Detect whether FOMA terminal is connected. n=0 : No busy tone, no dial tone detected, and no speed is displayed n=1 : No busy tone, no dial tone detected, and speed is displayed n=2 : No busy tone, dial tone detected, and speed is displayed n=3 : Busy tone detected, no dial tone detected, and speed is displayed n=4 : Busy tone detected, dial tone detected, and speed is displayed (default) When n=0 is set, AT&E and AT¥V command will be unavailable.
ATZ*3 ATZ [↵] OK (When in offline mode)	Reset the current setting to the registered state. When this command is executed during communication, the terminal is reset after the line is disconnected (displaying "NO CARRIER").
AT%V AT%V [↵] Ver1.00 OK	Display FOMA terminal version.
AT&C<n>*1 AT&C1 [↵] OK	Set the operating conditions of the circuit CD (DCD) for DTE. n=0 : Always ON n=1 : Vary according to line connection status (default) When set to n=0, the CD signal is set to ON directly before sending "CONNECT" when ending connection. The CD signal is set to OFF directly before the line is disconnected and "NO CARRIER" is sent.
AT&D<n>*1 AT&D2 [↵] OK	Set the operation performed when circuit ER (DTR) signal received from DTE is switched from ON to OFF while online data mode takes effect. n=0 : Ignore status (status is always considered to be ON) n=1 : Move to online command mode when status changes from ON to OFF n=2 : Disconnect line and move to offline mode when status changes from ON to OFF (default)

Upper slot : Command Lower slot : Example	Description
AT&E<n>*1 AT&E1 [↵] OK	Set the speed display used when connection is made. n=0 : Display communication speed of wireless zone n=1 : Display communication speed between a PC and FOMA terminal (default)
AT&F AT&F [↵] OK (When in offline mode)	Reset the current setting to the default. When this command is executed during communication, the terminal is reset after the line is disconnected (displaying "NO CARRIER").
AT&S<n>*1 AT&S0 [↵] OK	Set control of the data set ready (DR) signal to be output to DTE. n=0 : Always ON (default) n=1 : ON at time of connection
AT&W AT&W [↵] OK	Register the current settings in FOMA terminal.
AT * DANTE AT * DANTE [↵] * DANTE : 3 OK	Indicate FOMA terminal reception level in the " * DANTE : <n>" format. n=0 : Out of service area n=1 : Received signal level of FOMA terminal is 0 or 1 antenna. n=2 : Received signal level of FOMA terminal is 2 antennas. n=3 : Received signal level of FOMA terminal is 3 antennas. AT * DANTE=? : Display a list of displayable values
AT * DGANSM=<n>*2 AT * DGANSM=0 [↵] OK	Set to reject or permit incoming packet communications. n=0 : Reject setting = OFF, Accept setting = OFF (default) n=1 : Reject setting=ON n=2 : Accept setting=ON AT * DGANSM? : Display current settings AT * DGANSM=? : Display a list of assignable values
AT * DGAPL=<n> [<cid>]*2 AT * DGAPL=0,1 [↵] OK	Set the dialup connections (APN) to permit incoming packet communications. APN uses <cid> defined by +CGDCONT command. n=0 : Add to list of APN permitted for incoming communications n=1 : Delete from list of APN permitted for incoming communications If the <cid> is not defined by the +CGDCONT command, it can still be added to/deleted from the list. If the <cid> is omitted, all the <cid> are added to/deleted from the list. AT * DGAPL? : Display current settings AT * DGAPL=? : Display a list of assignable values
AT * DGARL=<n> [<cid>]*2 AT * DGARL=0,1 [↵] OK	Set the dialup connections (APN) to refuse incoming packet communications. APN uses <cid> defined by +CGDCONT command. n=0 : Add to list of APN rejected for incoming communications n=1 : Delete from list of APN rejected for incoming communications If the <cid> is not defined by the +CGDCONT command, it can still be added to/deleted from the list. If the <cid> is omitted, all the <cid> are added to/deleted from the list. AT * DGARL? : Display current settings AT * DGARL=? : Display a list of assignable values
AT * DGPIR=<n>*2 AT * DGPIR=0 [↵] OK	Set Caller ID notification when packet communication connection is being performed. This command is available when a communication is sent or received. n=0 : Connect to APN directly (default) n=1 : Connect to APN prefixing 184 n=2 : Connect to APN prefixing 186 When Show/Hide caller ID is specified by dialup network→P17 AT * DGPIR? : Display current settings AT * DGPIR=? : Display a list of assignable values
AT * DRPW AT * DRPW [↵] * DRPW : 0 OK	Indicate an index for the reception power of the radio waves that FOMA terminal receive. AT * DRPW=? : Display a list of displayable values
AT+CAOC AT+CAOC [↵] +CAOC : "000024" OK	Display last call cost.
AT+CBC AT+CBC [↵] +CBC : 0,100 OK	Display FOMA terminal's battery level in the "+CBC : <bcs>,<bcl>" format. bcs=0 : Powered by the battery pack bcs=1 : Not powered by the battery pack bcs=2 : Battery pack removed bcs=3 : Power-supply error bcl=0 : No battery remained or battery pack removed bcl=1-100 : Battery remained AT+CBC=? : Display a list of displayable values

Upper slot : Command Lower slot : Example	Description
AT+CBST=<n>,1,0^{*1}	Set the line to use (Setting of bearer service)
AT+CBST=116,1,0 OK	n=116 : 64K data communication (default) n=134 : 64K videophone AT+CBST? : Display current settings AT+CBST=? : Display a list of assignable values
AT+CDIP=<n>^{*1}	Set to notify/not to notify the sub address when receiving in packet communication or 64 data communication. And, subscription status of Multi Number can be confirmed.
AT+CDIP=0 OK	n=0 : The information of sub address is not displayed. (default) n=1 : The information of sub address is displayed. m=0 : Multi Number not subscribed. m=1 : Multi Number subscribed. AT+CDIP? : Display the current settings and status in the "+CDIP:<n>,<m>" format AT+CDIP=? : List of the settable values is displayed.
AT+CEER	Display the reason of immediate disconnection.
AT+CEER +CEER : 36 OK	Disconnection reason list → P32
AT+CGDCONT^{*2}	Set dialup connection (APN) for packet communication. → P33
→ P33	
AT+CGEQMIN^{*2}	Set the criteria for judging whether to permit QoS (Quality of Service) provisioned by the network when packet communication is established. → P34
→ P34	
AT+CGEQREQ^{*2}	Set QoS (Quality of Service) requested to the network at the transmission of packet communication. → P34
→ P34	
AT+CGMR	Display FOMA terminal version.
AT+CGMR 1234567890123456 OK	
AT+CGREG=<n>^{*1}	Set whether to report network service registration status (Within/Out).
AT+CGREG=0 OK	n=0 : Not notified (default) n=1 : When the terminal is moved from Within service area to Out of service area or vice versa, the status is reported in the "+CGREG : <stat>" format. stat=0 : Out of packet service area stat=1 : Within packet service area stat=4 : Unknown stat=5 : Within packet service area (during international roaming) AT+CGREG? : Display the current settings and status in the "+CGREG : <n>,<stat>" format AT+CGREG=? : Display a list of assignable values
AT+CGSN	Display FOMA terminal serial No.
AT+CGSN 123456789012345 OK	
AT+CLIP=<n>^{*1}	Set whether to display sender's caller ID on a PC when receiving 64K data communication.
AT+CLIP=0 OK	n=0 : Not display result (default) n=1 : Display result m=0 : Network setting not to send caller ID m=1 : Network setting to send caller ID m=2 : Unknown AT+CLIP? : Display the current settings and status in the "+CLIP : <n>,<m>" format AT+CLIP=? : Display a list of assignable values
AT+CLIR=<n>^{*2}	Set Caller ID notification when sending 64K data communication.
AT+CLIR=2 OK	n=0 : Use the setting in Caller ID notification of FOMA terminal n=1 : Not send n=2 : Send (default) m=0 : CLIR not operating (always sends) m=1 : CLIR operating (never sends) m=2 : Unknown m=3 : CLIR temporary mode (default=does not send) m=4 : CLIR temporary mode (default=sends) AT+CLIR? : Display the current settings and status in the "+CLIR : <n>,<m>" format AT+CLIR=? : Display a list of assignable values
AT+CMEE=<n>^{*1}	Set whether to display an error report at FOMA terminal.
AT+CMEE=0 OK	n=0 : Display "ERROR" and no result code (default) n=1 : Use result code, displaying reason as number n=2 : Use result code, displaying reason as alphabetic characters Display reasons in the "+CME ERROR : xxxx" format when n=1 or n=2 is set (xxxx = number or alphabetic characters). → P33 "Error messages list" AT+CMEE? : Display current settings AT+CMEE=? : Display a list of assignable values

Upper slot : Command Lower slot : Example	Description
AT+CNUM AT+CNUM [↵] +CNUM : „090XXXXXXX“, 129 OK	Display FOMA terminal's own phone number in the "+CNUM : <numbers>,<type>" format. number : Own phone number (With 2in1, display Number B in B mode or Number A in other mode) type=129 : International access code + not included type=145 : International access code + included
AT+COPS=<n>,2,<oper>*2	Set search method for network operator to connect. n=0 : Auto (default) n=1 : Manual n=3 : No mapping When n=1 is set, set PLMN Number in hexadecimal value for <oper>.
AT+COPS=0 [↵] OK	AT+COPS? : Display current settings AT+COPS=? : Display a list of assignable values
AT+CPAS AT+CPAS [↵] +CPAS : 0 OK	Display whether FOMA terminal can send and receive AT commands to external devices in "+CPAS : <n>" format. n=0 : Possible n=1 : Impossible n=2 : Status unknown n=3 : Possible and receiving n=4 : Possible and communicating AT+CPAS=? : Display a list of displayable values
AT+CPIN="<pin>","<newpin>"	Enter these commands for entering PIN1/PIN2 codes or PUK with PIN1 code ON. To enter PUK, enter new PIN1/PIN2 code in <newpin>. Even if entering in <newpin> when entry of PIN1/PIN2 code is request, PIN1/PIN2 code cannot be changed.
AT+CPIN="0000" [↵] OK	n=READY : Entry of code not requested n=SIM PIN : Entry of PIN1 code waited n=SIM PIN2 : Entry of PIN2 code waited n=SIM PUK : Entry of PUK waited due to failure in unblocking PIN1 code n=SIM PUK2 : Entry of PUK waited due to failure in unblocking PIN2 code AT+CPIN? : Display the code currently requested in "+CPIN : <n>" format
AT+CR=<n>*1	Set whether to display the communication type before "CONNECT" is displayed during connection. n=0 : Not display (default) n=1 : Display the communication type in the "+CR : <serv>" format serv=GPRS : Packet communication serv=SYNC : 64K data communication serv=AV64K : 64K videophone AT+CR? : Display current settings AT+CR=? : Display a list of assignable values
AT+CR=0 [↵] OK	
AT+CRC=<n>*1	Set whether to use +CRING result codes when communication is received. n=0 : Not use (default) n=1 : Use "+CRING : <type>" result codes type=GPRS "PPP",,"<APN>" : Packet communication type=SYNC : 64K data communication type=AV64K : 64K videophone AT+CRC? : Display current settings AT+CRC=? : Display a list of assignable values
AT+CRC=0 [↵] OK	
AT+CREG=<n>*1	Set whether to report network service registration status (Within/Out). n=0 : Not notified (default) n=1 : When the terminal is moved from Within service area to Out of service area or vice versa, the status is reported in the "+CREG : <stat>" format. stat=0 : Out of sound service area stat=1 : Within sound service area stat=4 : Unknown stat=5 : Within sound service area (during international roaming) AT+CREG? : Display the current settings and status in the "+CREG : <n>,<stat>" format AT+CREG=? : Display a list of assignable values
AT+CREG=0 [↵] OK	
AT+CUSD=<n>,<str>*1	Set Additional service (Register USSD) of Network Services. Enter Service code provided by DOCOMO in <str>. n=0 : Not answer mid result (default) n=1 : Answer mid result in "+CUSD : <m>,<str>,"0" format m=0 : Information not requested m=1 : Information requested AT+CUSD? : Display current settings AT+CUSD=? : Display a list of assignable values
AT+CUSD=0,"012345678" [↵] OK	
AT+FCLASS=<n>*1	Set communication type supported by FOMA terminal. n=0 : Only data supported (fixed value) AT+FCLASS? : Display current settings AT+FCLASS=? : Display a list of assignable values
AT+FCLASS=0 [↵] OK	
AT+GCAP AT+GCAP [↵] +GCAP : +CGSM,+FCLASS, +W OK	Display the range of AT commands supported by FOMA terminal in the "+GCAP : <n>" format. n=+CGSM : Support GSM commands (including the case for supporting a part) n=+FCLASS : Support +FCLASS commands n=+W : Support +W commands

Upper slot : Command Lower slot : Example	Description
AT+GMI AT+GMI [↵] FUJITSU OK	Display FOMA terminal manufacturer name.
AT+GMM AT+GMM FOMA F02D OK	Display model name of FOMA terminal.
AT+GMR AT+GMR [↵] Ver1.00 OK	Display FOMA terminal version.
AT+IFC=<n,m>*1 AT+IFC=2,2 [↵] OK	Set how to control local flow between a PC and FOMA terminal. n, m=0 : No flow control n, m=1 : Perform XON/XOFF flow control n, m=2 : RS/CS (RTS/CTS) Perform flow control (default) AT+IFC? : Display the current settings and status in the "+IFC : <n>,<m>" format (n is the value of DCE by DTE, and m is the value of DTE by DCE) AT+IFC=? : List of the settable values is displayed
AT+WS46=<n>*1	Display wireless network used when sending communication in n number. When entering AT+WS46=<n>, ERROR is returned because it cannot be changed. n=12 : GSM network n=22 : 3G network (FOMA) n=25 : GSM or 3G network (FOMA) (fixed value) AT+WS46? : Display current settings AT+WS46=? : Display a list of assignable values
AT¥S AT¥S [↵] E1 Q0 V1 X4 &C1 &D2 &S0 (snip) S104=001 OK	Display the currently set commands and S register settings.
AT¥V<n>*1 AT¥V0 OK	Set whether to use expanded result codes when connection is made. n=0 : Not use expanded result codes (default) n=1 : Use expanded result codes
+++ +++ (not displayed) OK	Move from online data mode to online command mode when entered during a communication. The escape guard interval is 1 second (fixed value).

*1 Registered in FOMA terminal by &W command.

*2 Not reset by &F and Z commands.

*3 When Z command is executed before the &W command, the terminal is reset to the last status registered in memory, and prior changes are erased.

◆ Disconnection reason list

■ Packet communication

Value	Description
26	APN is not present or is incorrect.
27	
30	Disconnected by network.
33	Terminal does not subscribe to packet communication.
36	Normal disconnection.

■ 64K data communication

Value	Description
1	Specified number does not exist.
16	Normal disconnection.
17	Communication is impossible because remote device is busy.
18	You made a call but did not receive a response within the specified time.
19	The remote device is called but no response.
21	The remote device rejected incoming calls.
63	The service and option of the network are not valid.
65	Unavailable processing speed was specified.
88	You made a call to a terminal or received a call from a terminal with different terminal properties.

◆ Error messages list

No.	Text display	Description
10	SIM not inserted	UIM is not set.
15	SIM wrong	Other than DOCOMO SIM (IC card equivalent to UIM) is inserted.
16	incorrect password	Incorrect password
100	unknown	Unknown error

◆ Supplement to AT command

- <cid> is the number used to control dialup connection (APN) for packet communication to be registered in FOMA terminal. "1-10" can be registered in FOMA terminal.
- By default, the following APNs are registered in cid1-4.
cid1 : mopera.ne.jp (APN mopera, PPP connection)
cid2 : mopera.net (APN mopera U, PPP connection)
cid3 : mopera.net (APN mopera U, IP connection)
cid4 : mpr.ex-pkt.net (APN mopera U, PPP connection, 128K communication)
- <APN> is an optional string for each connection to indicate dialup connection.

■ Command name : +CGDCONT=[parameter]

• Outline

Set dialup connection (APN) for packet communication.

• Format

+CGDCONT= [<cid> [, "<PDP_TYPE>" [, "<APN>"]]]

• Parameter description

<cid> : 1-10

<PDP_TYPE> : IP or PPP

<APN> : Optional

• Example of execution

The command used to register an APN named "abc" for PPP connection (when <cid>=5).

```
AT+CGDCONT=5,"PPP","abc" [↵]
```

```
OK
```

• Operation performed when parameter is omitted

AT+CGDCONT= : Return all <cid> to the setting by default.

AT+CGDCONT=<cid> : Return the specified <cid> to the setting by default.

AT+CGDCONT? : Display current settings.

AT+CGDCONT=? : Display a list of assignable values.

■ Command name : +CGEQMIN=[parameter]

• Outline

Set the criteria for judging whether to permit QoS (Quality of Service) provisioned by the network when packet communication is established.

• Format

AT+CGEQMIN= [<cid> [, <Maximum bitrate UL> [, <Maximum bitrate DL>]]]

• Parameter description

<cid> : 1-10

<Maximum bitrate UL> : None (default) or 5,760

<Maximum bitrate DL> : None (default) or 7,232

* For <Maximum bitrate UL> and <Maximum bitrate DL>, the maximum communication speed (in kbps) is set for both upload and download traffic between FOMA terminal and the base station. If the parameter is set to "None (default)", all speeds are permissible. If "5,760" and "7,232" are set, any connection at a speed less than the above limit is not permitted, and chances are that packet communication will not be connected.

• Example of execution

- Command used to permit all speeds both upload and download (when <cid>=5)

```
AT+CGEQMIN=5 [↵]
```

```
OK
```

- Command used to permit only 5,760kbps upload and 7,232kbps download (when <cid>=6)

```
AT+CGEQMIN=6,,5760,7232 [↵]
```

```
OK
```

- Command used to permit only 5,760kbps upload and all speeds download (when <cid>=7)

```
AT+CGEQMIN=7,,5760 [↵]
```

```
OK
```

- Command used to permit all speeds upload and only 7,232kbps download (when <cid>=8)

```
AT+CGEQMIN=8,,,7232 [↵]
```

```
OK
```

• Operation performed when parameter is omitted

AT+CGEQMIN= : Returns all <cid> to the setting by default.

AT+CGEQMIN=<cid> : Returns the specified <cid> to the setting by default.

AT+CGEQMIN? : Displays current settings.

AT+CGEQMIN=? : Displays a list of assignable values.

■ Command name : +CGEQREQ=[parameter]

• Outline

Set QoS (Quality of Service) requested to the network at the transmission of packet communication.

• Format

AT+CGEQREQ= [<cid>]

• Parameter description

Only commands that require connection at 64-5,760kbps upload, 64-7,232kbps download can be set. The contents are set by default for each <cid>.

<cid> : 1-10

• Example of execution

(when <cid>=3)

```
AT+CGEQREQ=3 [↵]
```

```
OK
```

• Operation performed when parameter is omitted

AT+CGEQREQ= : Returns all <cid> to the setting by default.

AT+CGEQREQ=<cid> : Returns the specified <cid> to the setting by default.

AT+CGEQREQ? : Displays current settings.

AT+CGEQREQ=? : Displays a list of assignable values.

◆ Result codes

- When ATV command is set to n=1 (default), the result code is displayed in alphabetic characters. When the command is set to n=0, the result code is displayed numerically. →P28

■ Result codes

No.	Text display	Meaning
0	OK	Operation performed normally
1	CONNECT	Terminal connected to other party
2	RING	Incoming call
3	NO CARRIER	Line disconnected
4	ERROR	Unable to accept command
6	NO DIALTONE	Unable to detect dial tone
7	BUSY	Detecting the busy tone
8	NO ANSWER	Completed connection Time-out
100	RESTRICTION	Network restriction in place (The communication network is busy. Please wait for a while and retry.)
101	DELAYED	Redial call restricted

■ Extended result code

- When AT&E is set to n=0

No.	Text display	Connection speed between FOMA terminal and base station
122	CONNECT 64000	64000bps
125	CONNECT 384000	384000bps
133	CONNECT 3648000	3648000bps
135	CONNECT 7232000	7232000bps

- When AT&E is set to n=1

No.	Text display	Connection speed between FOMA terminal and a PC
5	CONNECT 1200	1200bps
10	CONNECT 2400	2400bps
11	CONNECT 4800	4800bps
13	CONNECT 7200	7200bps
12	CONNECT 9600	9600bps
15	CONNECT 14400	14400bps
16	CONNECT 19200	19200bps
17	CONNECT 38400	38400bps
18	CONNECT 57600	57600bps
19	CONNECT 115200	115200bps
20	CONNECT 230400	230400bps
21	CONNECT 460800	460800bps

* To retain compatibility with a modem connected via conventional RS-232C, communication speed is displayed, but it differs from the actual connection speed because FOMA terminal is connected to a PC with a USB cable or Bluetooth function.

■ Communication protocol result code

No.	Text display	Meaning
1	PPPOverUD	Connect via 64K data communication (BC=UDI, +CBST=116,1,0)
3	AV64K	Connect via 64K videophone
5	PACKET	Connect via packet communication

■ Display example of result code

When ATX0 is set

Regardless of the settings of AT≠V command, only "CONNECT" is displayed upon completion of connection.

Text display example : ATD * 99 * * * 1#
CONNECT

Number display example : ATD * 99 * * * 1#
1

When ATX1 is set

- When ATX1, AT≠V0 (default) is set

Upon completion of connection, the result code is displayed in the following format : "CONNECT <speed between FOMA terminal - PC>".

Text display example : ATD * 99 * * * 1#
CONNECT 460800

Number display example : ATD * 99 * * * 1#
1 21

- When ATX1, AT≠V1 is set^{*1}

The code is displayed upon completion of connection in the following format.

"CONNECT<speed between FOMA terminal - PC><Communication protocol><dialup connection (APN)>/<upstream maximum speed (between FOMA terminal→radio base station)>/<downstream maximum speed (between FOMA terminal←radio base station)>"^{*2}

Text display example : ATD * 99 * * * 1#
CONNECT 460800 PACKET mopera.ne.jp/5760/7232

(Indicates the terminal is connected to mopera.ne.jp providing a maximum upload speed of 5,760kbps and a maximum download speed of 7,232kbps.)

Number display example : ATD * 99 * * * 1#
1 21 5

*1 When ATX1 and AT≠V1 are set at the same time, it is likely that dialup connection will fail. It is recommended that only AT≠V0 be used.

*2 When AT≠V1 is set, <dialup connection (APN)> and the following are displayed only when packet is used for connection.

Kuten Code List

For entering characters using code, see "Entering characters using code" in the attached manual.
 Note that some characters in the code input list may look different from actual ones.

1st -3rd	4th digit of code									1st -3rd	4th digit of code									1st -3rd	4th digit of code								
	0	1	2	3	4	5	6	7	8		9	0	1	2	3	4	5	6	7		8	9	0	1	2	3	4	5	6
010										081	上	十	一	一	一	一	一	一	一	一	一	203	款	飲	漢	潤	漣	瀧	看
011										082	十	十	一	一	一	一	一	一	一	一	一	204	管	管	緩	肝	監	監	観
012										083	十	十	一	一	一	一	一	一	一	一	一	205	誦	誦	邊	閑	閑	閑	館
013																					206	誦	誦	邊	閑	閑	閑	館	
014										130											207	廣	廣	廣	廣	廣	廣	館	
015										131											208								
016										132											209								
017										133											210								
018										134											211								
019										135											212								
020										136											213								
021										137											214								
022										138											215								
023										139											216								
024																					217								
026										160											218								
027										161											219								
028										162											220								
029										164											221								
031										164											222								
032										165											223								
033										166											224								
034										167											225								
035										168											226								
036										169											226								
037										170											227								
038										171											228								
039										172											229								
040										173											230								
041										172											231								
042										173											232								
043										173											232								
044										174											232								
045										174											233								
046										175											234								
047										176											235								
048										177											236								
048										178											237								
050										179											238								
051										179											239								
052										180											240								
053										181											241								
054										180											242								
055										182											243								
056										182											242								
057										182											243								
058										183											243								
060										184											244								
061										185											245								
062										186											246								
063										187											247								
064										188											248								
065										189											249								
070										190											250								
071										191											251								
072										192											252								
073										193											253								
074										194											254								
075										195											255								
076										196											256								
077										197											257								
078										199											259								
078										200											260								
080										201											261								
080										202											261								

