

FURUNO

Installation Guide v3.2

MFD8/12/BB software v2.07 and later



READ ME FIRST!

Please read this document before installing and powering ON your NavNet Display

INSTALLATION TOOLS YOU WILL NEED: An ordinary USB MOUSE AND USB KEYBOARD for the MFDBB Installation! These are also helpful with the MFD8/12 Installation.



FURUNO ELECTRIC CO., LTD.

www.furunousa.com



1. Mounting	Á
1.1. MFD8/12 Mounting.....	Á
1.1.1. MFD8/12 Flush Mounting	Æ
1.1.2. MFD 8/12 Desktop and Overhead Mounting	FG
1.2. MFDBB Processor Mounting.....	FH
1.2.1. MFDBB Processor Desktop or Deck Mounting.....	FH
1.2.2. MFDBB Processor Bulkhead Mounting	ÈI
1.2.3. MDBBB Keyboard Mounting.....	ÈI
2. Wiring.....	Ì
2.1. Overview	Ì
2.1.1. MFD8/12 Overview	Ì
2.1.2. MFDBB Overview	Ì
2.2. Power Connections	Ì
2.2.1. MFD8/12.....	Ì
2.2.2. MFDBB.....	Ì
2.3. DATA Ports (NMEA0183).....	1J
2.3.1. Overview.....	œ
2.3.2. DATA 1 description.....	Áœ
2.3.3. DATA 2 Description	GF
2.4. NMEA2000 Description and Information	GH
2.4.1. MFD.....	GH
2.4.2. DRS Radar	GH
2.4.3. NMEA2000-0183 Data Conversion and NMEA2000 Bridging	G
2.5. DRS (Radar) Connection	Ĝ
2.5.1. Connecting the DRS to MFD8/12	Ĝ
2.5.1. Connecting the DRS to MFDBB	2Ì
2.6. Network.....	2J
2.6.1. Introduction.....	2J
2.6.2. Power Synchronization.....	H€
2.7. Video Inputs	3I
2.7.1. Analog Video Inputs	3I
2.7.2. IP Cameras.....	3I
2.8. External Monitors	3Î
2.8.1. MFD8/12.....	3Î
2.8.2. MFDBB.....	3Î
2.9. USB and Audio Connection.....	3J
2.9.1. USB Ports.....	3J
2.9.2. Audio	I €
2.10. MFD8/12 Video, USB and Audio Connection	I €



2.10.1.	Waterproof Connection	1 €
2.10.2.	Non Waterproof connection.....	43
3.	Configuration.....	44
3.1.	Introduction	44
3.1.1.	Which MFD should be set as Master?	45
3.1.2.	Data Source Selection.....	45
3.1.3.	Installation Wizard Conceptual Description	45
3.2.	Master Setting and initial configuration	47
3.3.	Installation Wizard Own Settings.....	49
3.3.1.	Monitor (MFDBB only)	49
3.3.2.	NMEA2000 Data Configuration	49
3.3.3.	NMEA0183	51
3.3.4.	Analog Video	54
3.4.	Installation Wizard Global Settings.....	55
3.4.1.	Boat Parameter Settings.....	55
3.4.2.	Assigning Nicknames	56
3.4.3.	IP Camera	57
3.4.4.	Primary Data Source selection	57
3.4.5.	GPS Mode.....	58
3.4.6.	Sounder Configuration.....	60
3.4.7.	DRS (Radar) Configuration.....	64
3.5.	MFDBB Keyboard/Processor Linking.....	66
4.	Registering the System	67
4.1.	SystemID Description.....	67
4.2.	Registration Card	67
5.	Checklist	68
5.1.	Master	68
5.2.	Power Synchronization Configuration	68
5.3.	Heading Input.....	69
5.4.	NMEA2000 and NMEA0183 output sentences	70
5.5.	Powering Sequence	70
6.	Appendix	70
6.1.	Example NN3D System Configurations	70
6.1.1.	Basic Plotter/Fish Finder Installation	71
6.1.2.	Basic Plotter/Radar/Fish Finder Installation.....	71
6.1.3.	Dual MFD Installation Example	73
6.1.4.	Dual Screen MFDBB Installation with Pilot Integration	73





6.1.5. Dual Screen MFDBB with DRS and FAR21X7	76
6.2. Master Reset.....	77
6.2.1. MFDBB.....	77
6.2.2. MFD8/12.....	78
6.3. Configuring AXIS IP Cameras.....	79
6.3.1. Introduction:.....	79
6.3.2. Setting the IP of the computer	79
6.3.3. Set up the IP address of the camera	81
6.3.4. Configure the camera	84



SAFETY INSTRUCTIONS

The user and installer must read the appropriate safety instructions before attempting to install or operate the equipment.

 WARNING	Indicates a potentially hazardous situation which, if not avoided, could result in death or serious injury.
 CAUTION	Indicates a potentially hazardous situation which, if not avoided, may result in minor or moderate injury.

 Warning, Caution	 Prohibitive Action	 Mandatory Action
------------------------------------------------------------------------------------------------------	--------------------------------------------------------------------------------------------------------	-------------------------------------------------------------------------------------------------------

 WARNING
 ELECTRICAL SHOCK HAZARD Do not open the equipment unless totally familiar with electrical circuits.
<p>Only qualified personnel should work inside the equipment.</p>
 Turn off the power at the switchboard before beginning the installation.
<p>Fire or electrical shock can result if the power is left on.</p>
 Be sure that the power supply is compatible with the voltage rating of the equipment.
<p>Connection of an incorrect power supply can cause fire or damage the equipment.</p>

 CAUTION															
 Ground the equipment to prevent electrical shock and mutual interference.															
<p>Use the proper fuse.</p> <p>Use of an incorrect fuse may damage the equipment.</p>															
<p>Observe the following compass safe distances to prevent interference to a magnetic compass:</p> <table border="1" style="width: 100%; border-collapse: collapse; text-align: center;"> <thead> <tr> <th></th> <th>Standard compass</th> <th>Steering compass</th> </tr> </thead> <tbody> <tr> <td>MFD8</td> <td>0.90 m</td> <td>0.60 m</td> </tr> <tr> <td>MFD12</td> <td>0.85 m</td> <td>0.55 m</td> </tr> <tr> <td>MPU-001</td> <td>1.45 m</td> <td>0.90 m</td> </tr> <tr> <td>MCU-001</td> <td>0.55 m</td> <td>0.40 m</td> </tr> </tbody> </table>		Standard compass	Steering compass	MFD8	0.90 m	0.60 m	MFD12	0.85 m	0.55 m	MPU-001	1.45 m	0.90 m	MCU-001	0.55 m	0.40 m
	Standard compass	Steering compass													
MFD8	0.90 m	0.60 m													
MFD12	0.85 m	0.55 m													
MPU-001	1.45 m	0.90 m													
MCU-001	0.55 m	0.40 m													

Standard supply (MFD8/12)

Name	Type	Part Number (PN)	Qty	Remarks
Multi Function Display	MFD8	-	1	Choose one.
	MFD12	-		
Installation materials	CP19-00900	000-011-780	1 set	For MFD8, CP19-00901*, cables
	CP19-01000	000-011-781		For MFD12, CP19-01001*, cables
Spare Parts	SP19-00701	001-028-020	1 set	For MFD8, fuses
	SP19-00801	001-028-030		For MFD12, fuses
Accessories	FP19-01101	001-023-060	1 set	Panel/Bezel Removal tool

*See the lists at the end of this manual.

Optional supply (MFD8/12)

Name	Type	Part Number (PN)	Remarks
NMEA0183 and NMEA2000 Micro-cable Assemblies	MJ-A7SPF0007-050C	000-154-028	5 m, NMEA0183, w/7 pin Female connector (DATA1)
	M12-05BM+05BF-010	000-167-962	φ 6, 1 m, NMEA2000, w/M-F micro connectors
	M12-05BM+05BF-020	000-167-963	φ 6, 2 m, NMEA2000, w/M-F micro connectors
	M12-05BM+05BF-060	000-167-964	φ 6, 6 m, NMEA2000, w/M-F micro connectors
	M12-05BFFM-010	000-167-965	φ 6, 1 m, NMEA2000, w/micro connector
	M12-05BFFM-020	000-167-966	φ 6, 2 m, NMEA2000, w/micro connector
	M12-05BFFM-060	000-167-967	φ 6, 6 m, NMEA2000, w/micro connector
Ethernet Network Cable Assemblies	MOD-Z072-020+	000-167-175	LAN cross, 4-pair, 2 m
	MOD-Z072-050+	000-167-176	LAN cross, 4-pair, 5 m
	MOD-Z072-100+	000-167-177	LAN cross, 4-pair, 10 m
	MOD-Z073-030+	000-167-171	LAN straight, 2-pair, 3 m
	MJ-A6SPF0016-005C	000-159-689	For FAX-30, ETR6N/10N connection
NMEA 2000 Terminators and "T" Connectors	LTWSS050505FMF-TS001	000-168-603	NMEA 2000 "T" Connector, micro
	LTWMC-05BMMT-SL8001	000-168-604	NMEA 2000 terminator, male, micro
	LTWMC-05BFFT-SL8001	000-168-605	NMEA 2000 terminator, female, micro

Optional supply (MFD8/12) *(continued)*

Name	Type	Part Number (PN)	Remarks
DVI-D CABLE	DVI-D/D S-LINK	000-149-054	5 m, for Multi-purpose LCD connection. Single Link only.
	DVI-D/D S-LINK	CBL-DVI-10M	10 m, for Multi-purpose LCD connection. Single Link only.
External Buzzer	OP03-136	000-086-443	Suggest Radio-Shack 273-070 or equivalent
Junction Box	FI-5002	-	For FI-50 series/NMEA2000 Terminal Strip Connections
Network Hub	HUB-101	-	NN3D Hub with Sleep Mode Signal Compatibility
RJ45 Junction Box	RJ45-to-RJ45 Straight	RJ4-5CN-STR	For Mast-Step or LAN cable extension
Connector Boot	OP19-7	001-028-090	Waterproofing Kit for MFD8/12 exposed connection points
Operator's Manual	OME-4440	000-167-802	-
NMEA 2000 Interface Unit	IF-NMEA2K1	-	Use where NMEA2000-to-NMEA0183 Data conversion is required for legacy products

Standard supply (MFDBB)

Name	Type	Part Number (PN)	Qty	Remarks
Processor Unit	MPU-001	-	1	Choose one.
Control Unit	MCU-001	-	1	
Display Control Unit	DCU12	-	1	
Installation Materials	CP19-00600	000-011-664	1 set	For MPU-001, Cable, CP19-00601*
	CP19-00700	000-011-663	1 set	For MCU-001, cable, CP19-00701*
	CP19-00800	000-011-662		For DCU12, cables, CP19-00801*
Spare Parts	SP19-00501	001-023-090	1 set	For MPU-001, Fuses
	SP19-00501	001-023-040	1 set	For DCU-001, Fuses
Accessories	FP19-01201	001-033-760	1	For MCU-001, panel remover
	FP19-01101	001-023-060		For DCU12, panel remover

*See the lists at the end of this manual.

Optional supply (MFDBB)

Name	Type	Part Number (PN)	Remarks
DVI-D Cable	DVI-D/D S-Link	000-149-054	5 m, for Multi-purpose LCD connection. Single Link only.
	DVI-D/D S-LINK	CBL-DVI-10M	10 m, for Multi-purpose LCD connection. Single Link only.
External Buzzer	OP03-136	000-086-443	
Network Hub	HUB-101		
RJ45 Junction Box	RJ45-to-RJ45 Straight	RJ4-5CN-STR	For LAN cable extension
Junction Box	FI-5002	000-010-765	For NMEA 2000
Control Unit	MCU-001	-	-
Display Control Unit	DCU12	-	-
Cable Assembly	MJ-A7SPF0007-050C	000-154-028	5 m, NMEA0183, w/7P connector
	MJ-A6SPF0016-005C	000-159-689	For FAX-30, ETR6N/10N connection
	MOD-Z072-020+	000-167-175	2 m, LAN
	MOD-Z072-050+	000-167-176	5 m, LAN
	MOD-Z072-100+	000-167-177	10 m, LAN
	MOD-Z073-030+	000-167-171	3 m, for PC connection
	M12-05BM+05BF-010	000-167-962	φ6, 1 m, NMEA 2000
	M12-05BM+05BF-020	000-167-963	φ6, 2 m, NMEA 2000
	M12-05BM+05BF-060	000-167-964	φ6, 6 m, NMEA 2000
	M12-05BFFM-010	000-167-965	φ6, 1 m, NMEA 2000
	M12-05BFFM-020	000-167-966	φ6, 2 m, NMEA 2000
	M12-05BFFM-060	000-167-967	φ6, 6 m, NMEA 2000
	CB-05PM+05BF-010	000-167-968	φ10, 1 m, NMEA 2000
	CB-05PM+05BF-020	000-167-969	φ10, 2 m, NMEA 2000
	CB-05PM+05BF-060	000-167-970	φ10, 6 m, NMEA 2000
	CB-05BFFM-010	000-167-971	φ10, 1 m, NMEA 2000
	CB-05BFFM-020	000-167-972	φ10, 2 m, NMEA 2000

Optional supply (MFDBB) *(continued)*

Name	Type	Part Number (PN)	Remarks
Cable Assembly	CB-05BFFM-060	000-167-973	φ10, 6 m, NMEA 2000
NMEA Connector	LTWSS-050505-FMF-TS001	000-168-603	NMEA 2000 distributor (micro style)
	LTWMC-05BMMT-SL8001	000-168-604	NMEA 2000 terminator, male (micro style)
	LTWMC-05BFFT-SL8001	000-168-605	NMEA 2000 terminator, female (micro style)
	LTWNC050505FMF-TS001	000-160-507	NMEA 2000 distributor (mini style)
	LTWMN-05AMMT-SL8001	000-160-508	NMEA 2000 terminator, male (mini style)
	LTWMN-05AFFT-SL8001	000-160-509	NMEA 2000 terminator, female (mini style)
Operator's Manual	OME-44460	-	-
NMEA2000 Interface Unit	IF-NMEA2K1	-	-

1. Mounting

1.1. MFD8/12 Mounting



MFD8



MFD12

When selecting a mounting location for the NN3D MFD8/12, keep the following in mind:

- The temperature and humidity of the mounting location should be moderate and stable.
- Install the unit away from exhaust pipes and ventilators.
- The mounting location should be well ventilated.
- Mount the unit where shock and vibration are minimal.
- Keep the units away from electromagnetic field generating equipment such as motors and generators.
- For maintenance and checking purposes, leave sufficient space from the sides and the rear of the unit and leave slack in cables. Minimum recommended space is shown the outline drawing for the display units.
- A magnetic compass will be affected if the display unit is placed too close to it. Observe the compass safe distances shown in the **SAFETY INSTRUCTIONS** to prevent disturbances to the magnetic compass.

The MFD8/12 can be flush or bracket mounted in a variety of ways.

1.1.1.MFD8/12 Flush Mounting

1. Prepare a cutout in the mounting location using the template sheet (supplied) for the MFD8 or 12.
2. Remove the front panel from the MFD by grasping it at its sides and pulling it towards you.
3. Attach the mounting gasket (sponge) to the display unit.
4. Fix the display unit by using four self-tapping screws (supplied).
5. Attach the front panel to the display.

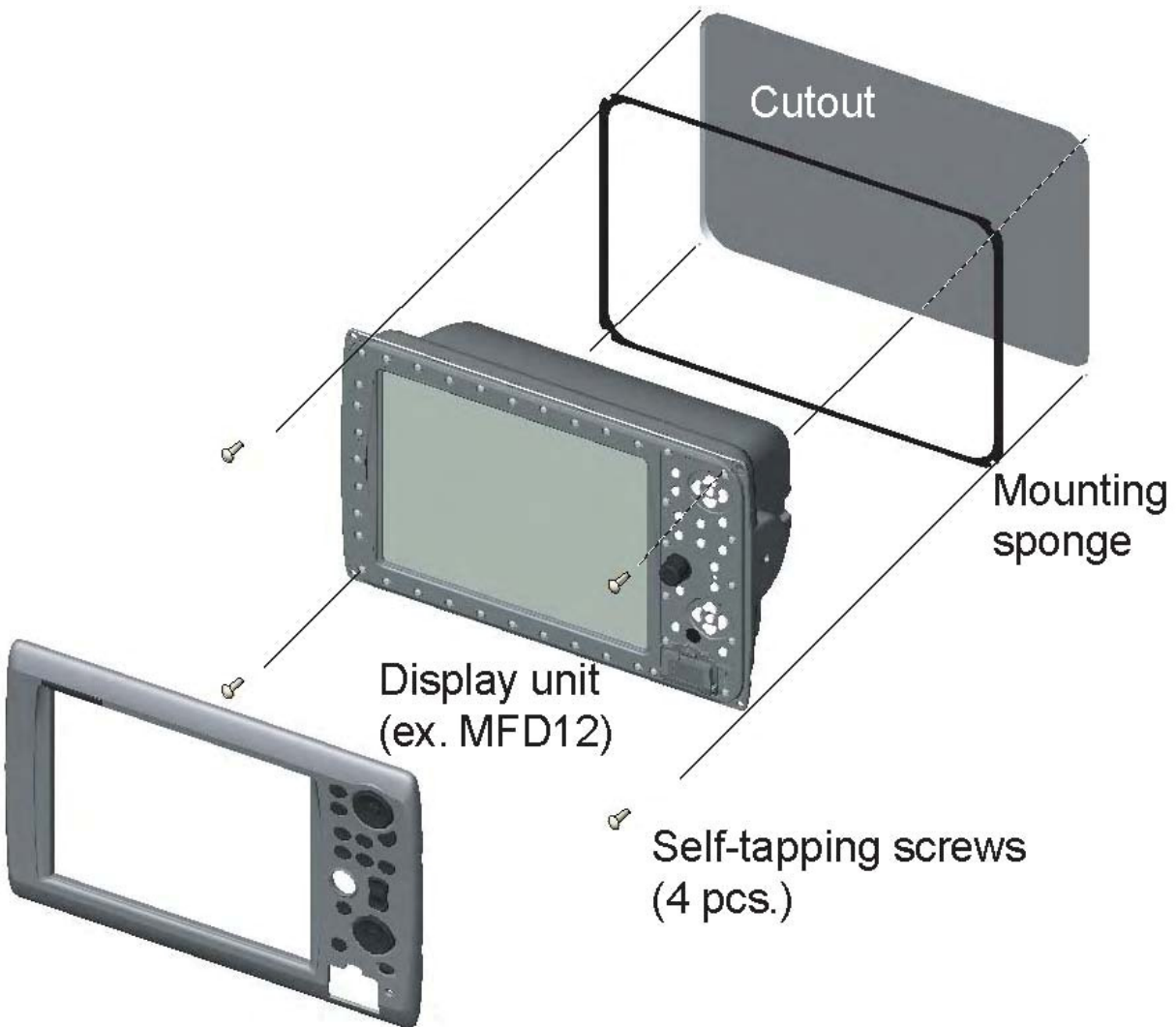

How to detach the front cover when flush mounted.

To detach the front panel when the unit is flush mounted, use the special tool (supplied) as below.

WARNING: The front cover may be damaged if this procedure is not followed!

1. Insert the tool in the notch on the lower side of the unit.



2. Pull the tool to raise the panel slightly. Repeat this action for all notches on the lower side of the unit.



3. Insert the tool into the small notches located on the sides of the panel, and pull the tool to raise the panel slightly.



4. Use your hands to detach the front panel from the lower side.



1.1.2.MFD 8/12 Desktop and Overhead Mounting

Follow the procedure below to mount the MFD8 or 12 on a desktop or overhead.

1. For MFD12, attach the liner to each side of the display unit. (Reverse the MFD12 Liners for overhead mounting.)
2. Fix the bracket (Hanger) by using self-tapping screws (supplied).
3. Screw knob bolts into the display unit, set it to the bracket (Hanger), and tighten the knob.

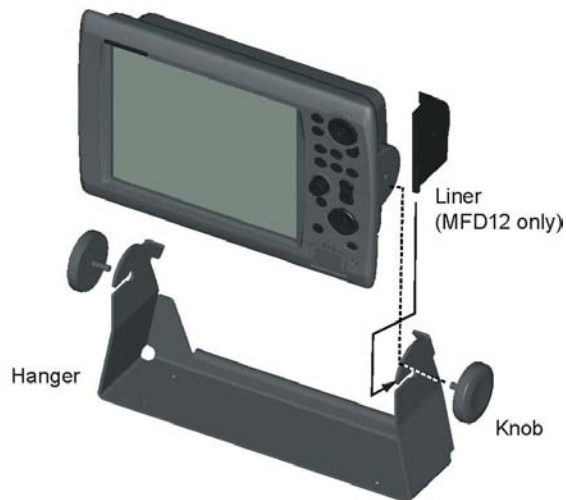

1.2. MFDBB Processor Mounting

The unit can be mounted on the deck, a desktop or on a bulkhead. Take special note that the MFDBB **IS NOT WATERPROOF**. Select a mounting location considering the points below:

- Select a location where temperature and humidity are moderate and stable.
- Consider the lengths of the cables connected among the processor unit, radar sensor and control unit.
- For mounting on a bulkhead, be sure the mounting location is strong enough to support the unit under the pitching and rolling normally encountered on the vessel.
- Leave sufficient space around the unit for maintenance and servicing. Minimum recommended maintenance space appears in the outline drawing at the back of this manual.
- A magnetic compass will be affected if the processor unit is placed too close to the magnetic compass. Observe the compass safe distances in **SAFETY INSTRUCTIONS** to prevent disturbance to the magnetic compass.

1.2.1. MFDBB Processor Desktop or Deck Mounting

Fasten with four self-tapping screws.

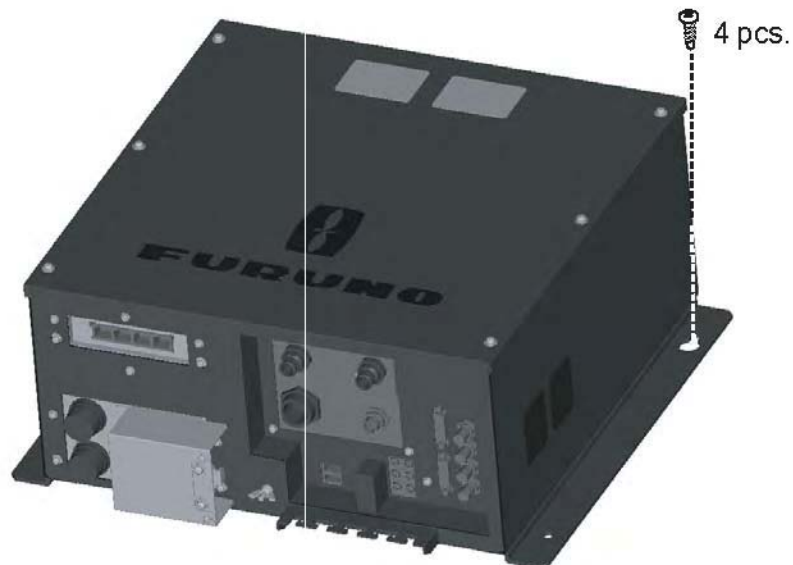

1.2.2.MFDBB Processor Bulkhead Mounting

Mark four fixing holes positions on the bulkhead. Screw in two 6x30 self-tapping screws at upper fixing positions, leaving 5 mm protruding. Set the processor unit to the screws and screw in two self-tapping screws at lower positions. Tighten all screws.

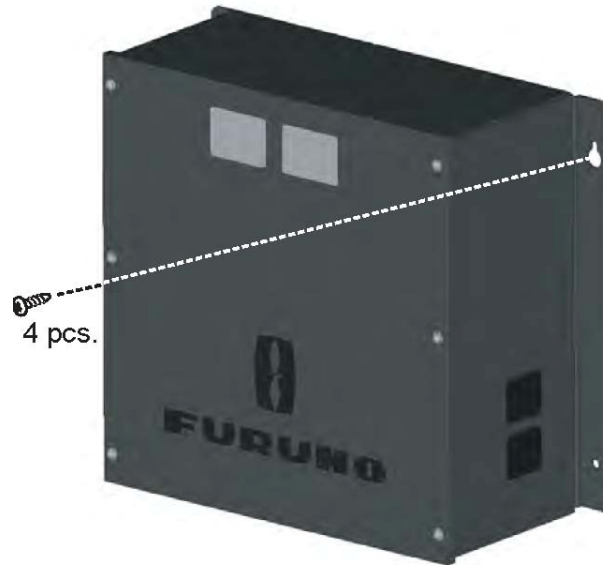

1.2.3.MFDBB Keyboard Mounting

The BlackBox keyboard (control unit MCU-001) is designed to be flush mounted in a console or panel.

1. Prepare a cutout in the mounting location using the template sheet (supplied) for the MCU-001.
2. Remove the front panel from the MCU-001 by grasping it at its sides and pulling it towards you.
3. Attach the mounting gasket (sponge) to the MCU-001.
4. Fix the MCU-001 by using four self-tapping screws (supplied).
5. Attach the front panel to the MCU001.

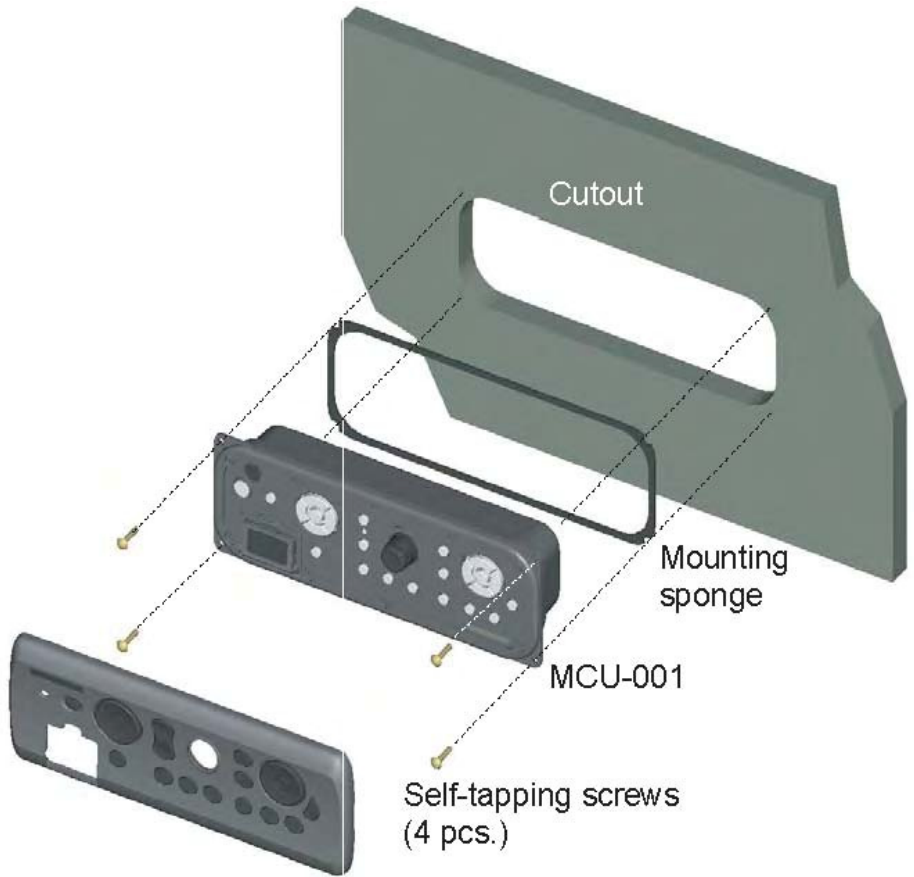

How to detach the front panel when flush mounted

To detach the front panel when the unit is flush mounted, use the tool (supplied) as below. Do not attempt to remove it by any other method, to prevent damage to the unit.

1. Insert the tool to the left-side notch at the bottom of the unit



2. Pull the tool to raise the panel slightly.

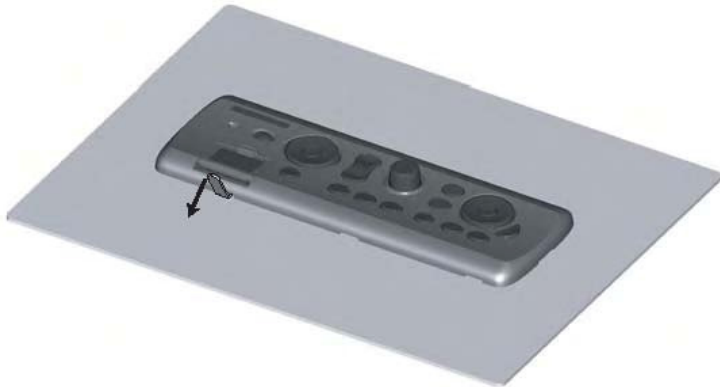

3. Similarly use the tool to raise the panel at the right-side notch.

4. Insert the tool to the space at the one end of the unit, and pull it to raise the panel slightly. Repeat this procedure for the opposite side.



5. Use the tool to raise the panel at the two notches on the upper side of the unit.

6. Use your hands to detach the front panel at both sides of it



2. Wiring

2.1. Overview

2.1.1.MFD8/12 Overview

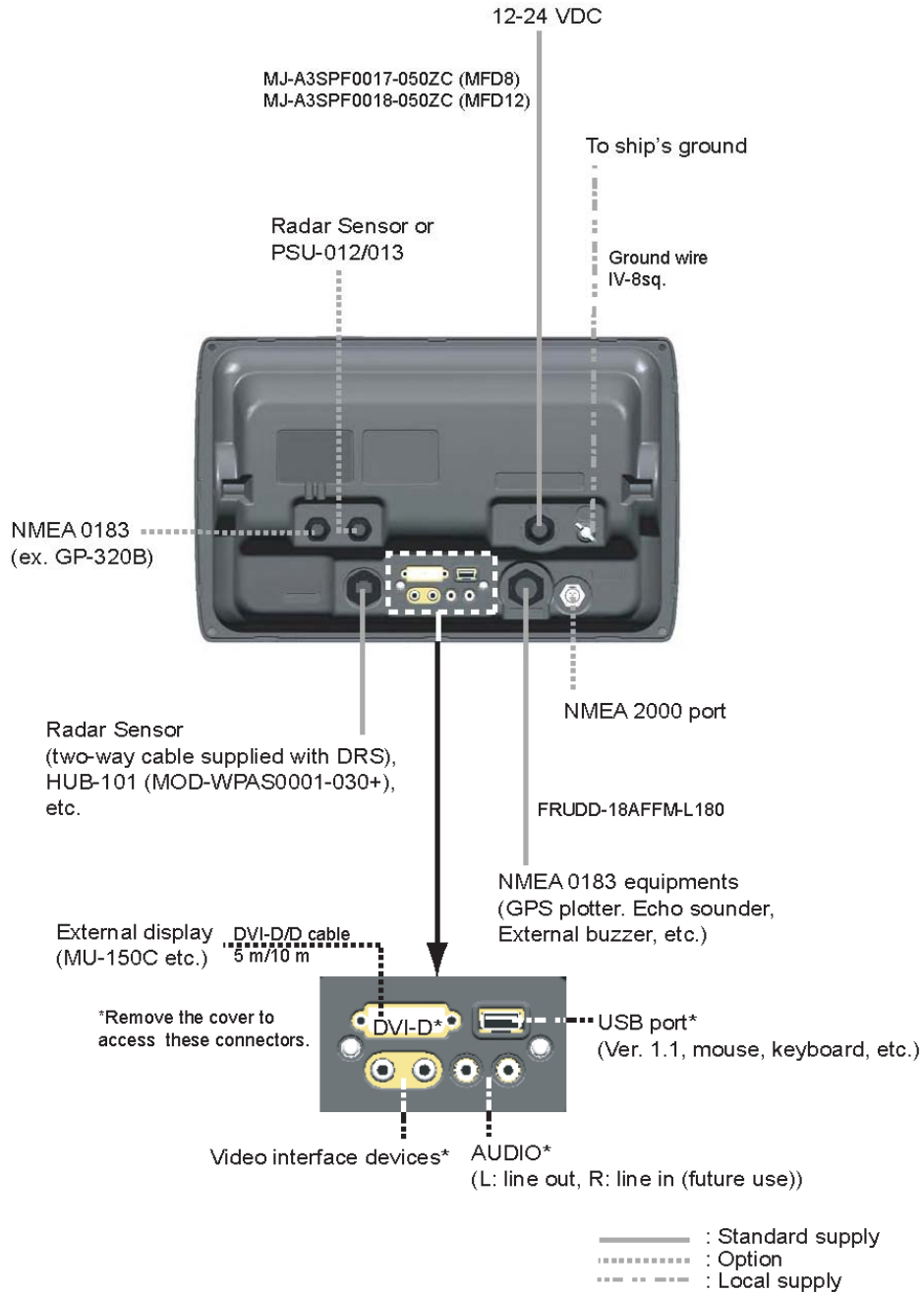

2.1.2.MFDBB Overview

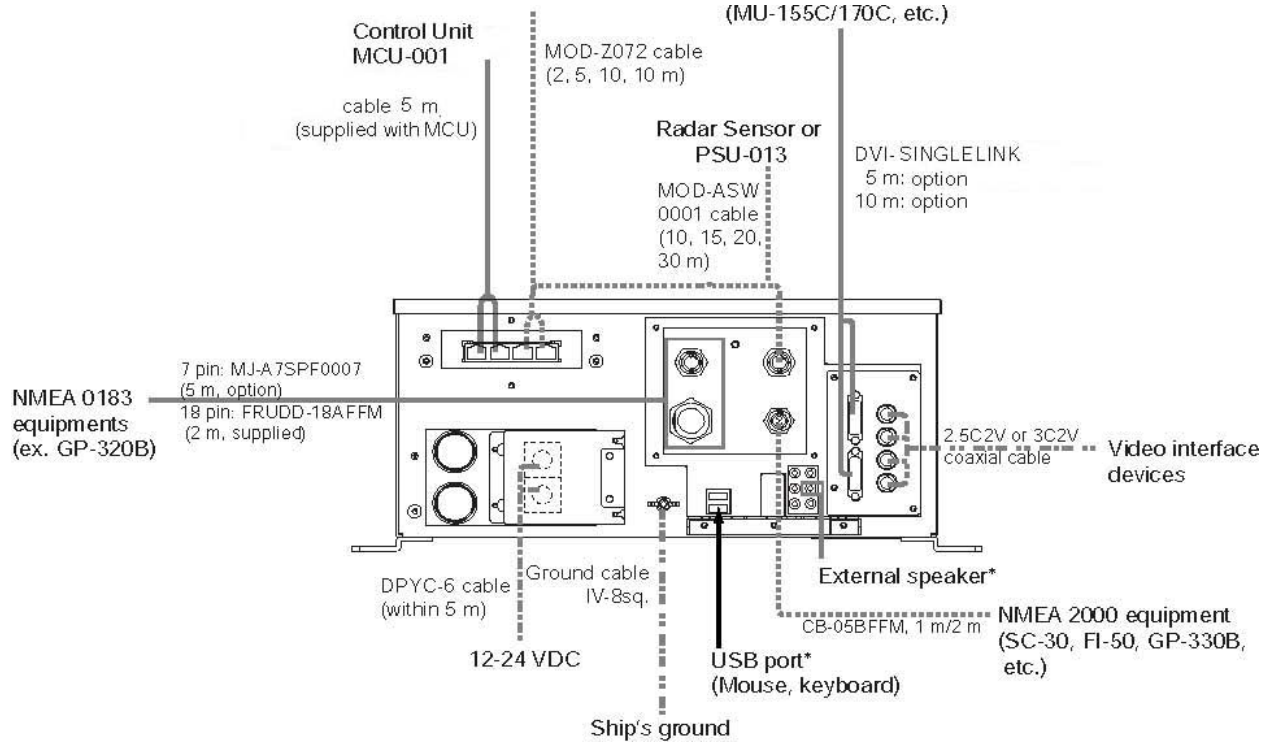

2.2. Power Connections

2.2.1.MFD8/12

The MFD8/12 can be powered directly using nominal 12V or 24V DC. Only use the power cable supplied with the unit and connect it to the Power Connector at the rear of the unit.

2.2.2.MFDBB

The MCU001 - MFDBB processor unit can be powered using 12V or 24V. Make up a 10 AWG power cable as shown below.

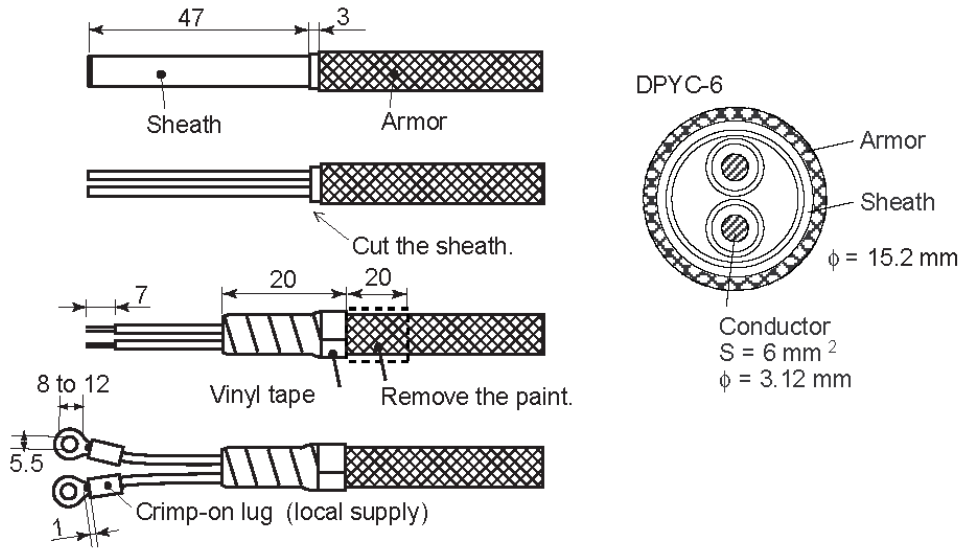

To connect the power cable, remove the Power Terminal cover. Unfasten the four pan head screws and connect the power cable to the power terminal (upper: +, lower: -). Reattach the cover. Note that the recommended maximum cable length is 5 m.

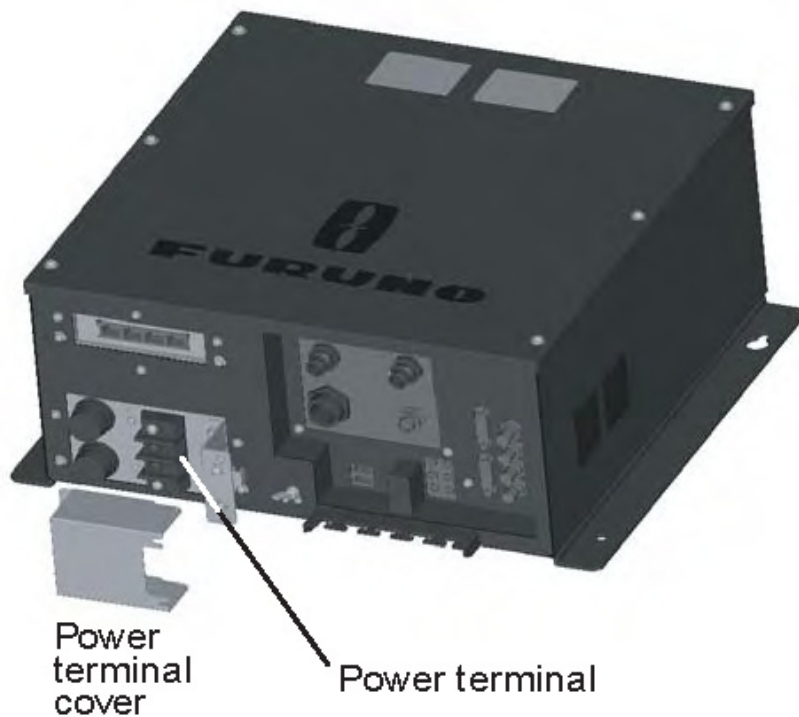

2.3. DATA Ports (NMEA0183)

2.3.1. Overview

Every MFD8/12 and MFD8/12 has THREE full NMEA0183 I/O Data Ports. One is available on the DATA1 (7-Pin Connector) and is pin compatible with NavNet 1/VX2 DATA1 Connector. Two additional NMEA Ports are available on the DATA2 (18-Pin connector).

These NMEA connections can accept a baud rate of 4800 or 38.4K. Any instrument (GPS, AIS, Smart Sensor, etc...) can be connected to any port.

Heading: Heading input to NavNet 3D will allow functions such as Radar Overlay and course stabilization (North Up, Course Up, etc.) in Radar operating modes.

IMPORTANT: The NMEA0183 **heading refresh rate needs to be 100ms** (10 times per second or faster) in order for the Radar ARPA function to work properly. If ARPA is not used, the refresh rate of heading information can be 200ms (5 times per second) to support radar overlay on the plotter. **NavNet 3D MFDs WILL NOT ACCEPT NMEA 0183 heading information if the refresh rate is only updated at 1 or 2 times per second!!** NMEA0183 heading can be accepted on any NMEA port at a baud rate up to 38.4kbps. Note that changing the baud rate on any of the three NMEA0183 Data ports will affect both the receive and transmit baud rate. In other words, data sent and received, must use the same baud rate for each individual data port. Please refer to the Appendix (p. 74) for installation example with the Furuno Pilot and Magnetic Compass PG500R.

Note: Heading data from a NMEA2000 source/sensor will always be at the correct refresh speed for the DRS ARPA function.

2.3.2. DATA 1 description

DATA1 uses a 7 Pin round plug. In many cases the DATA1 will be used to directly connect a Furuno GPS GP320B (P/N BBWGPS).

Other NMEA0183 compatible devices (Compass, AIS, Sounder, Smart Sensor...) can be connected by using a 7pin connector-to-pigtail cable (P/N 000-154-028).

Wiring Information

Pin No.	Color	Function
7	Shield	Shield
6	Black	GND
5	Red	12V_OUT
4	Green	RD1-B [(-)NMEA1 IN]
3	Yellow	RD1-A [(+)NMEA1 IN]
2	Blue	TD1-B [(-)NMEA1 OUT]
1	White	TD1-A [(+)NMEA1 OUT]

2.3.3.DATA 2 Description

The DATA2 Port can be used to connect additional NMEA 0183 instruments. Use the included cable assembly FRUDD-18AFFM-L180 (P/N 000-164-608). This included Pig-Tail Cable has an 18-Pin connector. DATA2 also provides additional Input/Output interfacing connections (Buzzer, Event ...). For example, a MOB Contact Closure Input may be connected to PIN 15 and 11*.

*Note that any MFD will interface to virtually any MOB System or Event switch (Point Save) contact closure signal using these pins.



Wiring Information

Pin No.	Color	Function	Remark (Port No.)
18	Light green	NET-C IN (0V)	NMEA 2000 Power IN: When 12V DC power is applied on these pins, the NMEA2000 port will provide power (up to 1 amp)
17	Pink	NET-S IN (+12V IN)	
16	Purple	Shield	
15	White	BUZZER or EVENT IN	External Buzzer Output or MOB/Event Input (Contact Closure)
14	Gray	SPEED-ALARM C	Speed alarm contact. Can trigger and external alarm or device when speed reaches a setup limit
13	Yellow	SPEED-ALARM H	
12	Black/White	+12V	External buzzer power ONLY (100mA Max)
11	Black	GND	GND for Event/MOB Input
10	Blue/White	RD3-B [(-)NMEA3 IN]	Port 3
9	Blue	RD3-A [(+)NMEA3 IN]	
8	Green/White	TD3-B [(-)NMEA3 OUT]	
7	Dark Green	TD3-A [(+)NMEA3 OUT]	
6	Orange/White	GND	
5	Orange	GND	
4	Brown/White	RD2-B [(-)NMEA2 IN]	Port 2
3	Brown	RD2-A [(+)NMEA2 IN]	
2	Red/White	TD2-B [(-)NMEA2 OUT]	
1	Red	TD2-A [(+)NMEA2 OUT]	

2.4. NMEA2000 Description and Information

2.4.1.MFD

Every MFD has one NMEA2000 port (Standard “DeviceNet Micro” style connector). This port is not powered unless External Power is applied on Pins 18 and 17 of DATA2, and must be connected to a properly configured NMEA2000 network.

IMPORTANT: Each MFD is designed to connect to separate NMEA2000 Networks/Backbones! All MFD and DRS use “Ethernet bridging” to link separate NMEA2000 networks/backbones. NEVER connect NMEA2000 ports between MFDs and/or DRS products.

2.4.2.DRS Radar

In addition to the NMEA2000 port found on the MFD processor, all DRS radar sensors have one powered CANBUS port (Terminal Strip connector). You may directly connect various Furuno NMEA2000 sensors to the DRS radar sensor without having to run a separate NMEA2000 cable up the mast. The total number of sensors that can be connected to the CANBUS DRS port without external power connection depends on power consumption. The DRS can supply up to 1 amp (20 LEN) to the DRS CANBUS network.

Please note that the CANBUS network connected to the DRS behaves like an independent NMEA2000 Backbone and needs to be terminated at both ends by a Terminating Resistor. A 120 Ohm resistor is standard supply with the DRS to terminate one side of the backbone. For example, if you install a SC30, WS200, or GP330 with the DRS CANBUS Port, you must have two terminators in the backbone. One can be at the sensor and the other located inside the DRS as shown below:

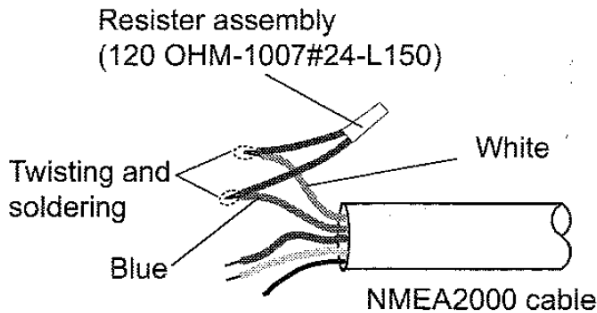

Please refer to the DRS Installation Guide for more information about connection.

2.4.3.NMEA2000-0183 Data Conversion and NMEA2000 Bridging

NMEA0183 to NMEA2000 conversion

NMEA0183 sentences and NMEA2000 PGNs, which are used and accepted in the MFD network can be converted and output in either/both NMEA0183/NMEA2000 formats. Note that only one type of data can be converted and output at a time (one position, one depth, one heading...). In case of multiple GPS sensors, the position output is the one currently selected as the primary sensor in an MFD network. This NN3D prioritizing function allows NMEA2000 products to utilize older NMEA0183 sensors and vice-versa. For example, you can connect a NMEA0183 Wind Instrument such as the Airmar PB100 to NavNet3D, and have the corresponding information output on one (or several) MFD NMEA2000 ports to feed a NMEA2000 display such as the Furuno FI50. The opposite is also true.

Ethernet Bridging of Individual NMEA2000 Networks/Backbones

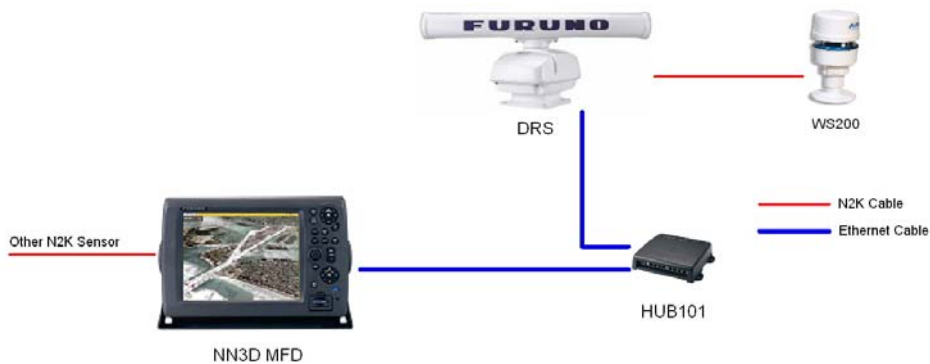

You may ONLY connect one MFD or DRS to the same NMEA2000 Network. Some NN3D vessels may contain several smaller NMEA2000 Networks where data from each NMEA2000 network is linked via the High-Bandwidth NN3D Ethernet Network. In these cases, each separate NMEA2000 network will be “Bridged” together via the NN3D Ethernet Network. NN3D MFD NMEA2000 and DRS CANBUS ports shall also not be connected together. In the case where NMEA2000 engine data, or other ship’s data, is introduced to the NN3D Network, the connection is made to only one MFD, and this MFD will bridge the data to other MFDs in the network.

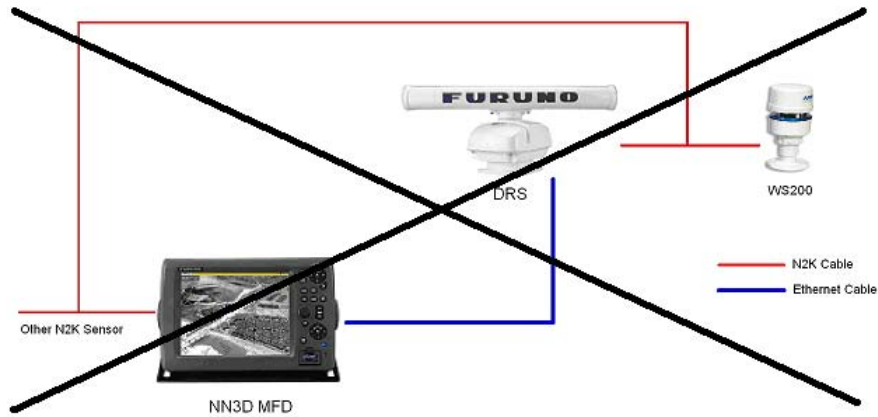

2.5. DRS (Radar) Connection

Up to two DRS (Digital Radar Sensors) can be connected to a NavNet3D network. Every DRS comes with a supplied 15 Meter cable (FUSA P/N 000-167-636). Other cable lengths may be purchased if necessary (Note that the part numbers for the DRS25A are different):

- 10 Meter Cable (FUSA P/N 000-167-635)
- 20 Meter Cable (FUSA P/N 000-167-637)
- 30 Meter Cable (FUSA P/N 000-167-638)

The Radar cable is a “Siamese” type cable that carries power (48V) and Data (Ethernet). All MFD have a dedicated Power Port (48V) used to connect the Radar Power Cable. Some combinations require an additional Power Supply Unit (PSU) in order to provide enough power for the DRS. Please refer to the following table:

	DRS2D	DRS4D	DRS4A	DRS6A	DRS12A	DRS25A
MFD8			PSU-012	PSU-012	PSU-012	PSU-013
MFD12					PSU-012	PSU-013
MFDBB						PSU-013

Note: DRS25A antenna includes PSU-013 as standard supply

2.5.1. Connecting the DRS to MFD8/12

Standalone Installation:

When the MFD8/12 and the Radar are the only Ethernet sensors, you can connect the Radar Ethernet connection directly to the back of the MFD8/12.

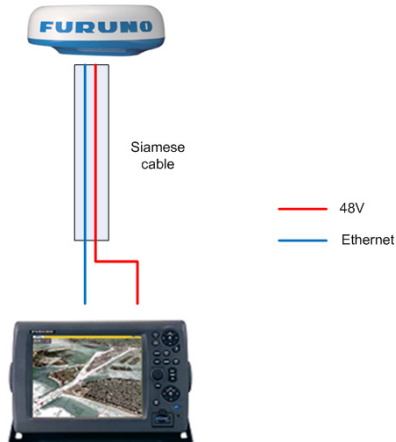

Network Installation:

As soon as multiple MFD8/12 or other Ethernet sensors (i.e. DFF1 Fish Finder, BBWX1 Sirius receiver, etc.) are used, the Radar Ethernet connection must be connected to an Ethernet Hub. In this case an Ethernet coupler can be used to extend the Ethernet part of the Siamese Cable

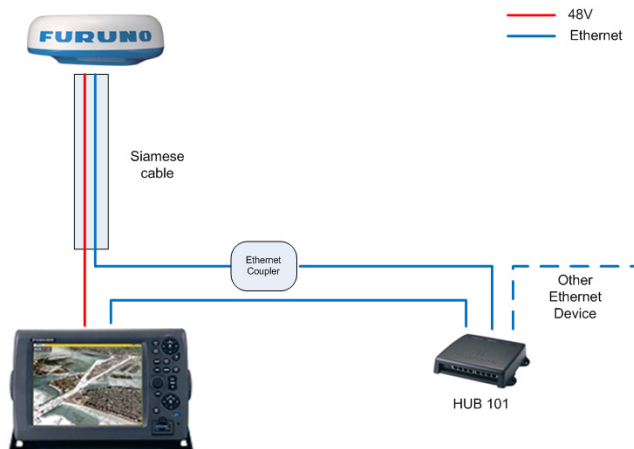

Example of straight Ethernet Coupler (FUSA P/N= RJ4-5CN-STR):



Note: This Ethernet coupler is not waterproof.

PSU Installation with the HUB101:

When a PSU is used with the Furuno HUB101, connect the MFD(s) and Radar as shown below:

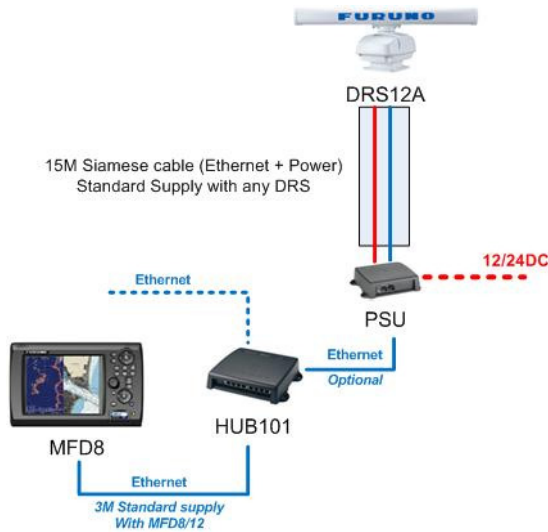

IMPORTANT: Make sure that the Power Synchronization Dip switches are set to ON inside the HUB101 where the MFD(s) and PSU are connected. (Please refer to the paragraph “Power Synchronization” p.26 for more information)

PSU Installation with a regular Hub:

When a PSU is used with a regular HUB, the MFD MUST BE directly connected to the Ethernet port on the PSU:

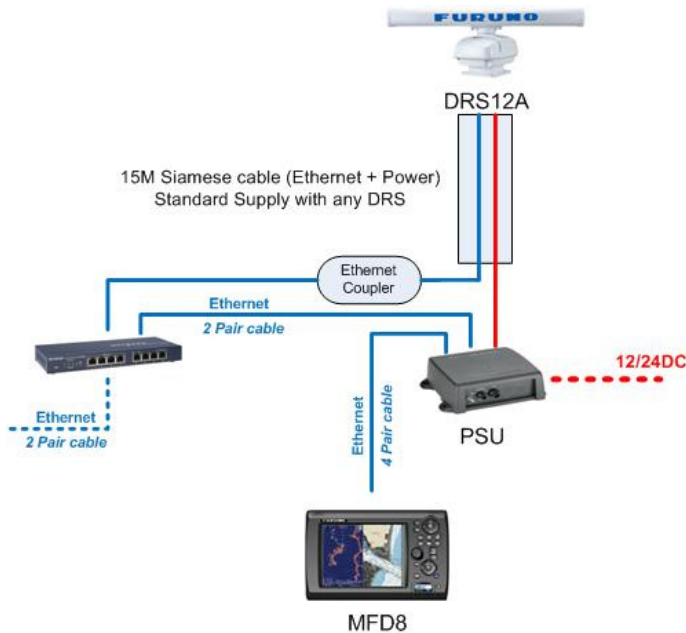

*Note: In case of multiple MFDs, connect the MFD set as “Master” directly to the PSU.
(Please refer to the paragraph “Which MFD should be set as ” p.46 for more information)*

Ethernet Cables that can be used to extend the Ethernet Radar Connection:

- 2 Meter RJ45 to RJ45 Ethernet Cable (P/N 000-167-175)
- 5 Meter RJ45 to RJ45 Ethernet Cable (P/N 000-167-176)
- 10 Meter RJ45 to RJ45 Ethernet Cable (P/N 000-167-177)

Please refer to the DRS Installation Guide for more information on connections inside the antenna.

2.5.1.Connecting the DRS to MFDBB

The MFDBB has an integrated HUB that allows simultaneous connection of the DRS Ethernet cable and other Ethernet devices (HUB101 for example).

Note: Ethernet Ports 1 and 2 are dedicated for connection of the MCU001 Keyboard.

Connect the DRS Ethernet Cable to Ethernet Port 3. Ethernet Port 4 will be available to connect the HUB 101 or other Ethernet sensor.

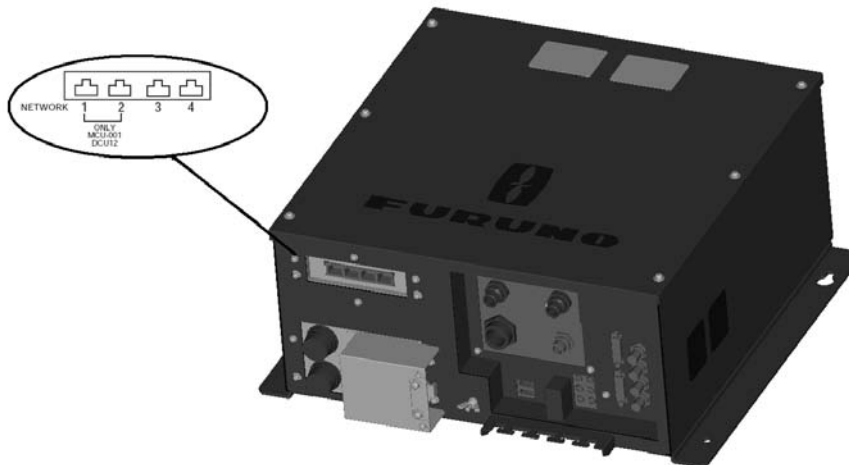

2.6. Network

2.6.1. Introduction

NavNet3D (just like NavNet1 and VX2) uses standard TCP/IP Ethernet to share radar/sounder images and other navigation information from devices connected within a networked system. In any single NavNet 3D network, a combination of UP to TEN NavNet3D MFDs may be networked together. All NavNet3D Network Components have one integrated regular RJ45 Ethernet port (with the exception of the MFDBB which has an integrated hub). Legacy NavNet components such as the ETR-6/10N (FUSA P/N BBFF1) or ETR-30N (FUSA P/N BBFF3) network sounder will need to be connected using the Hub Adapter Cable 6 Pin to RJ45 (FUSA P/N = 000-144-463). AUTO MDI/X - All NN3D MFDs, DRS and the HUB101 incorporate automatic straight and cross-over Ethernet Cable detection and switching. Therefore any combination of straight and cross-over Ethernet Cables can be utilized when installing network cabling.

MFDB/12

The MFDB/12 has one Waterproof Ethernet Port on the rear of the unit. It comes with standard supply of a 3 meter Ethernet Cable (FUSA P/N =000-164-809) terminated at one end with a Waterproof connector and at the other end with a regular RJ45. This cable can be extended using a coupler (FUSA P/N= RJ4-5CN-STR) and a regular Ethernet Cable. Please note that the coupler is not waterproof and thus needs to be installed accordingly.

MFDBB

The MFDBB Processor Unit contains an integrated hub that provides 4x Ethernet ports. Two of these ports are **exclusively dedicated** to the keyboard (control unit MCU001) connection. The MFDBB keyboard must be directly connected to one of the dedicated Ethernet ports on the BB (the MCU001 Control Unit cannot be connected to an Ethernet Hub/Switch). The Keyboard comes standard with a 5 meter Ethernet cable, but other lengths may be used:

- 2 Meter RJ45 to RJ45 Ethernet Cable (P/N 000-167-175)
- 5 Meter RJ45 to RJ45 Ethernet Cable (P/N 000-167-176)
- 10 Meter RJ45 to RJ45 Ethernet Cable (P/N 000-167-177)

Note: The Keyboard uses the Ethernet cable for both Power and Data. Do not plug anything else beside the Keyboard in Ethernet Port 1 or Port 2 on the MFDBB. These two ports are NOT standard POE (Power over Ethernet) and POE devices cannot be connected to these two ports.

2.6.2. Power Synchronization

A NN3D network is a system in which all components share information (navigation data, settings, points, routes, etc) with each other. Furuno developed special Power Synchronization features to allow proper network synchronization and functionality.

Sleep Mode:

The MFDs have a special “sleep mode” that allows each MFD to process data while consuming low power. NN3D MFDs can be in 3 states:

- **ON:** This is the regular mode of operation. The screen is ON, the Power Light is green and the user can interact with the device. The unit can process and share information on the network.
- **OFF:** The MFD is completely OFF and doesn't process information. No power is consumed in this state.
- **Sleep Mode:** The screen is off, the Power Light is orange and no user interaction is possible (except turning the unit ON with the Power Key). Even though the MFD appears off and the LCD is black, it will still process and share information with other MFDs on the network. The MFD consumes lower current in this state. Any NMEA2000/0183 and DRS sensors attached to the MFD ports will still function normally when an MFD is in Sleep Mode.

NN3D Sleep Mode Functional Description: (Software Version 2.01 and higher)

When the first MFD in a network is powered ON (using the power key), all the other networked MFD(s) will start automatically (power synchronization) and will go into sleep mode. Pressing the Power key of an MFD in sleep mode will turn it ON. Pressing the power key to turn OFF one MFD will turn OFF all the other networked MFD(s). In order to put a specific MFD back into sleep mode, select the RotoKey “Sleep”

IMPORTANT: Power Synchronization functionality requires the use of Furuno proprietary Hubs. The Internal MFDBB Hub and the optional Furuno HUB101 both provide NN3D Power Synchronization functionality. **Use of other generic Ethernet Hubs/Switches, while allowed, will not enable NN3D Power Synchronization!**

Caution must also be used in that only “Two Pair” Ethernet cables may be utilized with generic hubs/switches so that the Power Synchronization signals are not short circuited by “Four Pair” Ethernet cables. Note also that enabling the Power Synchronization function in Navnet 3D is also very important for proper Data Synchronization and system integrity! Please refer to next paragraph for more information.

Why use the Furuno HUB (HUB101):

The Furuno HUB101 allows the Power Synchronization signal to reach the MFDs and other Power Synchronization compatible devices. Here is a list of all devices that support Power Synchronization:

- All NN3D Displays: MFD8, MFD12, MFDBB
- All NN3D Radar Power Supplies: PSU012 and PSU013
- Sounders: DFF1 and DFF3
- HUB101

Note: the DRS itself does NOT need the Power Synchronization Signal as its power comes directly from an MFD or a PSU. These units provide the Power to the DRS directly.

Here is a list of all devices that are not compatible with the Power Synchronization Signal (ignore):

- BBWX1
- DRS antenna (only the PSU needs the Power Synchronization signal)
- BB Keyboard (MCU001)
- FA30 and FA50
- FAX30
- BBFF1 and BBFF3
- Computer

The Power Synchronization signal is transmitted using a normally unused wire of the Ethernet Cable (PIN 4 and Pin 5) thus a “4-Pair” Ethernet cable must be used to connect Power Synchronization compatible device. If a regular Ethernet switch is used instead of the Furuno HUB101, “2-Pair” Ethernet cables must be used between each MFD and the generic Ethernet Switch so that the Furuno Power Synchronization signal does not interfere with or harm the Ethernet Switch. Furuno offers a 3 meter 2 Pair Ethernet cable (FUSA P/N= 000-167-171).

Note: The Power Synchronization signal is only used for starting up the system. The shutdown is an Ethernet software command and thus will also work with a regular HUB.

Example of “2-Pair” Ethernet Cable:

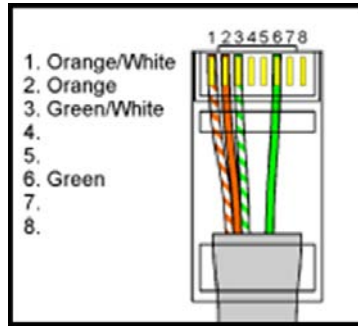

In addition to allow the Power Synchronization signal to pass, the Furuno HUB101 has switches that can be set to “block” this signal thus allowing connection with non-compatible Power Synchronization devices (PC, FAR-Series Radar ...). Please refer to next paragraph for more information.

The Power Synchronization feature also allows the NN3D’s unique “Data Synchronization” feature to operate properly providing redundancy and Point/Route/Track Data Synchronization between networked MFDs. Failure to enable Power Synchronization in a multiple MFD system could lead to system data loss or unintentional data updating and overwriting!

Note: If the Power Synchronization is **NOT (not using HUB101)** used, make sure that the MFD set as Master is **ALWAYS** the first MFD powered on the network!!!
(Please refer to the paragraph “Which MFD should be set as ” p.4641 for more information)

How to configure the Power Synchronization:

HUB101: The Furuno HUB101 has switches for each individual Ethernet port that can enable/disable its Power Synchronization function. When connected to an MFD or other Power Synchronization compatible devices (PSU, DFF1...), the switch must be configured to allow Power Synchronization. When connected to any other device (PC, previous generation sensors...) the switch **MUST** be configured to disable the Power Synchronization to protect other devices from the Power Synchronization signal. Please refer to the Installation Guide of the HUB101 for more information.

Note: A 2-Pair Ethernet cable is recommended when connecting a PC to a NavNet3D network (FUSA P/N= 000-167-171).

MFDBB: The MFDBB processor unit has an Internal Hub that is compatible with Power Synchronization. DIP switches inside the processor unit can be turned ON or OFF to enable/disable the Power Synchronization feature. The number on each DIP switch corresponds to the port number.

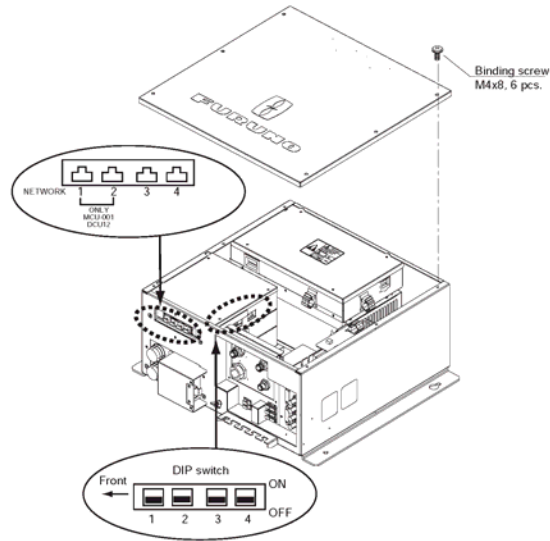

Note: The MFDBB Ethernet Port1 and Port2 are dedicated to connect the BB Keyboard. Leave these switches on OFF as the Keyboard does not need the Power Synchronization signal.

DFF1/DFF3: The DFF1 has DIP switches that need to be set up differently if you use a regular hub or the Furuno HUB101 (with Power Synchronization).

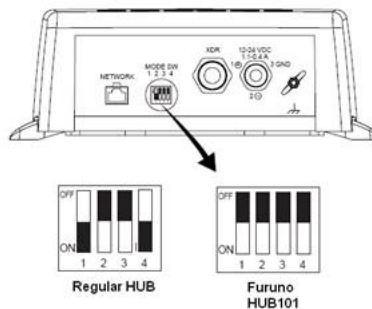

When you set up the Dip switches for the HUB101 (all dip switches in the UP position), the DFF1 will NOT power ON until one MFD is powered on (until the Power Synchronization Signal is received). If the Power Synchronization signal is not received on the DFF1, the Power LED (green light) will not light up even if you apply 12-24V to the unit. In this case make sure that you are using 4-Pair Ethernet cable and that the Power Synchronization DIP switches inside the HUB101 and MFDBB (if applicable) are ON.

If you are using a regular Hub that cannot pass the Power Synchronization signal, make sure that the Dip switches are “Down-Up-Up-Down”. In this configuration, the DFF1 will power ON as soon as power is applied to the unit.

The DFF3 follows the same concept (only the DIP switches change):

- Regular HUB (no Power Synch.) = DIP switch 1 and 2 are set to ON
- HUB101 (Power Synch.) = DIP Switch 1 and 2 are set to OFF

2.7. Video Inputs

NavNet3D can use regular analog video inputs (PAL or NTSC) that connect to the MFDs directly or use IP Cameras that connect directly to the network HUB. IP Cameras can be seen by all MFDs connected to the NN3D network unlike analog video that can be viewed only on the MFD where the source is connected. Additionally some IP Cameras can be controlled from NavNet3D (Pan-Tilt-Zoom “PTZ” IP Cameras only)

2.7.1. Analog Video Inputs

MFD8/12

The MFD8/12 units have 2 Analog Video inputs (PAL/NTSC) on 2 mm RCA (cinch) type connectors located on the rear of the display

MFDBB

The MFDBB unit has 4 Analog Video inputs (PAL/NTSC) on BNC type connectors (75 Ohms) located on the processor unit

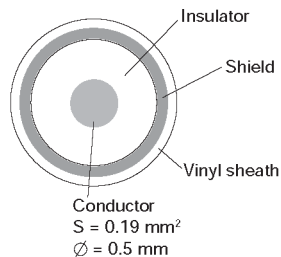

2.7.2. IP Cameras

IP Cameras are network devices that connect directly to a HUB. Up to 4 IP Cameras can be connected to one NavNet3D network. At this time, only AXIS IP Cameras (www.axis.com) that support MPEG4 Video are compatible with NN3D. Certain Axis PTZ (Pan-Tilt-Zoom) IP Cameras may also be controlled with NN3D Systems for features such as pan, tilt, and zooming. When connecting an IP Camera to the HUB101, make sure that the dip switch for Power Synchronization is set to OFF (refer to the paragraph “Power Synchronization” p.26 for more information).

When Power Over Ethernet (POE) AXIS IP cameras are installed (example: AXIS212PTZ) Furuno recommends utilizing a separate POE Ethernet Switch to provide

power and Ethernet data to each AXIS IP Camera with a single cable. Then, utilize a non-POE port on this switch to link the IP Cameras to a HUB101 in a NN3D Network.

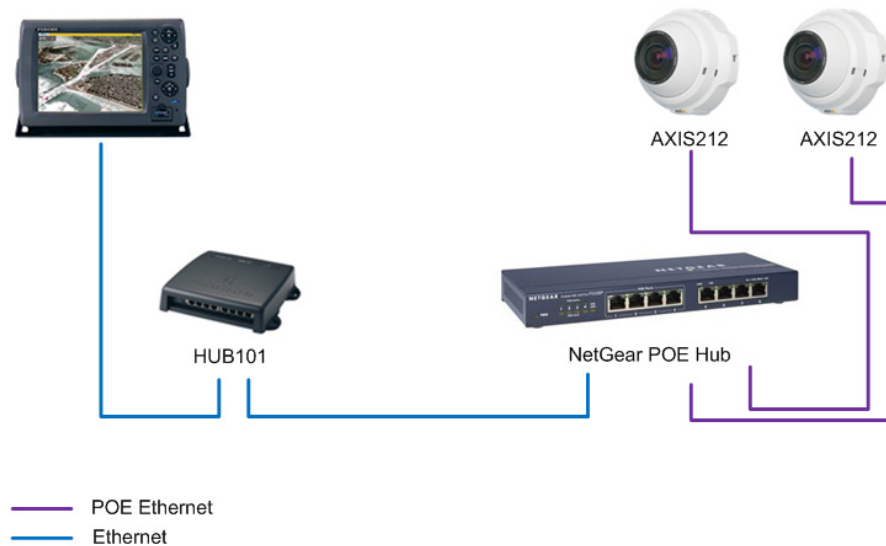

IMPORTANT: Never connect a POE port to the HUB101. Always use one of the NON-Powered ports to connect the HUB101 to the POE Hub.

The IP cameras need to have a specific assigned IP address (from 172.31.200.003 through 172.31.200.006).

Please refer to the appendix for more information on how to configure the AXIS IP Camera.

2.8. External Monitors

IMPORTANT: Never connect or disconnect a DVI or VGA cable while the MFD is running. Always power OFF the MFD before making any change to a connection. The same remark applies when powering ON or OFF a monitor.

2.8.1. MFD8/12

A DVI monitor can be connected to the MFD8/12 to repeat the screen at a remote location. The plug is DVI-D format and only a DVI monitor can be connected.

The MFD8 has a 640x480 (VGA) DVI-D output. The MFD12 has an 800x600 (SVGA) DVI-D output. Furuno offers the following DVI cables:

- 5 Meter DVI Cable (FUSA P/N= 000-149-054)
- 10 Meter DVI Cable (FUSA P/N= CBL-DVI-10M)

Note: The DVI-D Vertical frequency output is 56Hz on the MFD12 and 60Hz on the MFD8. Make sure that the monitor is compatible with these frequencies.

Please refer to the paragraph “Waterproof Connection” p.42 when a waterproof connection is needed.

2.8.2. MFDBB

The MFDBB has two DVI-I output ports (Matched Selectable Res from 800x600 up to 1280x1024). The DVI-I output of the MFDBB will “Autosense” the monitors and allow either DVI monitors or VGA monitors to be plugged in using a “DVI-I-to-VGA” adaptor:



IMPORTANT: When a DVI cable is used, we recommend using only “single link” type DVI Cables (avoid “double link” type cables).



Single Link
DVI Cable



Double Link
DVI Cable

Note: The DVI and VGA Vertical frequency output is 60Hz on the MFDBB.

When two monitors are connected to the MFDBB, you can choose to configure the monitors either in Clone Mode or in Extended Mode.

Note: When two monitors are connected to the MFDBB processor unit, they need to be capable of displaying the same resolution. The MFDBB cannot output a different resolution on each port.

When Extended Mode is used the two screens need to be located in close proximity to each other (Side-by-Side). The two monitors will show two different screen displays that can be configured independently. Only one Keyboard is used to control both monitors (the cursor will “jump” back and forth from monitor to monitor).

Clone mode is selected when either one or two monitors are installed for separate station configurations. A dual station requires a dual keyboard installation from one processor unit. In this case both monitors will show the same picture information.

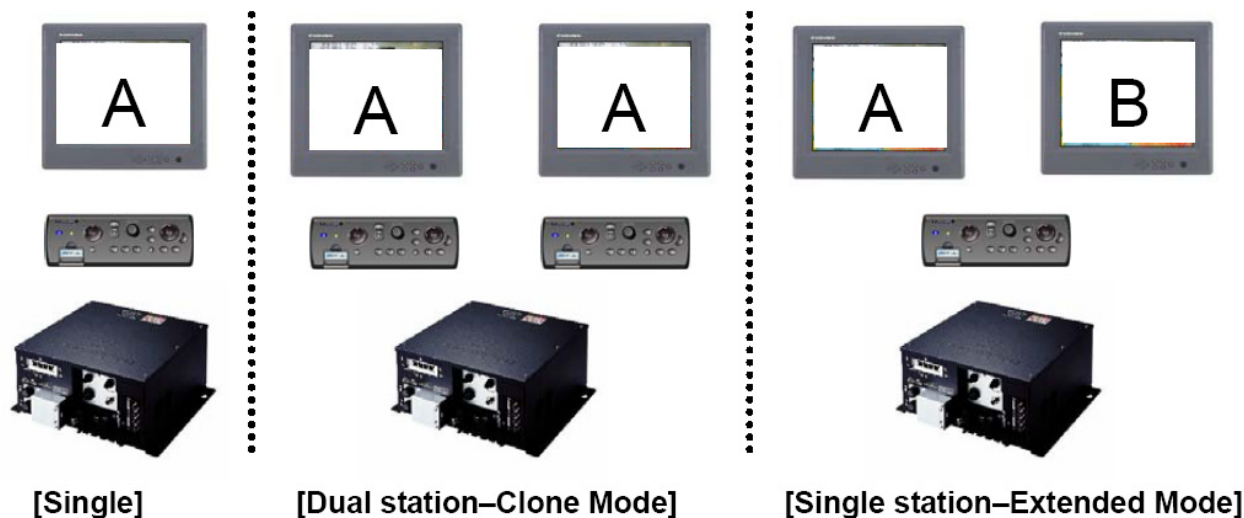

Furuno offers the following DVI cable:

- 5 Meter DVI Cable (FUSA P/N= 000-149-054)
- 10 Meter DVI Cable (FUSA P/N= CBL-DVI-10M)

Note: *All the DVI cables provided by Furuno are single link DVI-D Cables.*

2.9. USB and Audio Connection

2.9.1.USB Ports

The MFD8/12 has one USB Ver. 1.0 port and the MFDBB has two USB Ver. 2.0 ports.

These USB ports are used to connect a generic USB mouse and Keyboard. Virtually any "off the shelf" USB mouse (wired or RF wireless but NOT Bluetooth) will work with NavNet3D. However, in order to utilize full RotoKey functionality, you will need a mouse that has a scroll wheel that is also "clickable" with a middle click, which will emulate selection and confirmation of a desired RotoKey function. No loading of additional mouse software is permitted. However, the standard Mouse HID drivers will load automatically, allowing most mice and wireless mice to work fine.

Generic USB keyboards may be used to enter Name and Numerical Position. The Keyboard can also emulate the key of NavNet3D:

<u>USB Keyboard</u>	<u>Action</u>
ESC	CANCEL
F2	SAVE/MOB
F3	DISP
F4	MENU
F5	GAIN/TX
F6	CTRL
F7	DATA/VOL
F8	GO TO/LIST
F9	POINTS/ROUTE
F10	RANGE OUT
F11	RANGE IN
F12	SHIP/3D
Arrows (up, down, left, right)	SCROLLING PAD

Page Up	RotoKey Counter Clockwise
Page Down	RotoKey Clockwise
Enter	Push on RotoKey
End	Power/Brill

Note: The USB port can also be used to load charts on the MFDBB (using a USB flash Drive or a SD-Card to USB adapter). Due to the USB speed limitation (USB ver. 1.0) this is not possible on the MFD8/12

2.9.2. Audio

Audio In and Audio out are reserved for future Development.

2.10. MFD8/12 Video, USB and Audio Connection

The DVI, USB, Analog Video Input and Audio In/Out ports are behind the connector cover on the rear panel. To access to the ports and connect the cables, please refer to the instructions below. Note that these connection points require an optional waterproof connector boot if necessary. These connection points are not a waterproof design without this option. Any water egress in this area will not be covered by the limited warranty.

Note: *The Waterproof Connector Boot is only required if the DVI, USB or Audio connections are used and waterproofing is necessary for the MFD's location.*

2.10.1. Waterproof Connection

Waterproof connections for the DVI, USB, Analog Video Input and Audio I/O ports require the optional connector boot (Type: OP19-7, PN: 001-028-090).

Content of Waterproofing Kit

Name	Type	Code No.	Qty
Boot cover	19-028-3141	100-342-642-10	1
Fixing metal	19-028-3142	100-342-650-10	1
Rubber stopper	19-028-3143	100-342-660-10	1
Cable tie	CV-150B	000-167-183-10	1
Binding screw	M3x10	000-162-662-10	4

1. Unfasten the four screws to remove the connector cover at the rear of the display unit.

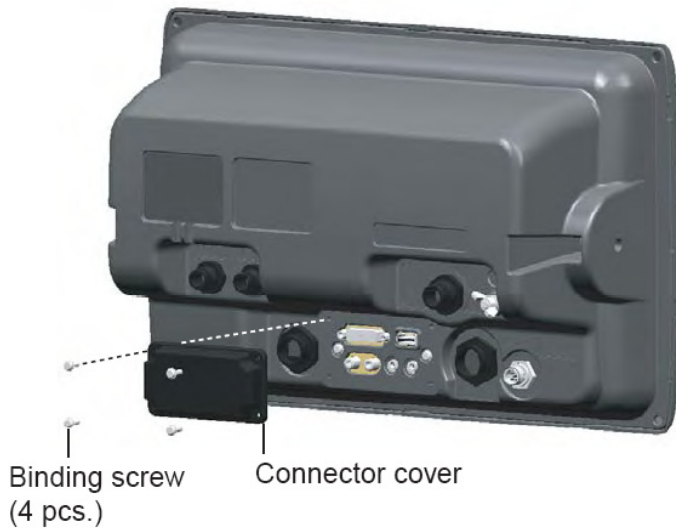

2. Pass DVI-D, VIDEO, AUDIO and/or USB cables through the fixing plate (supplied).

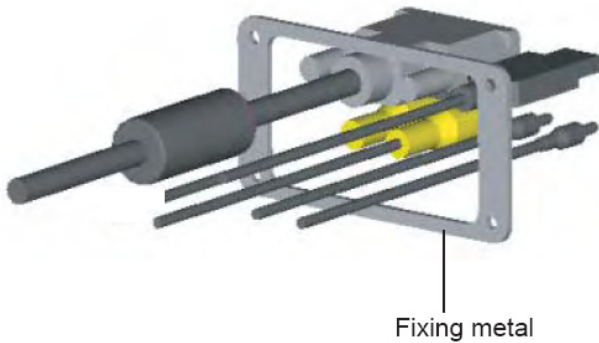

3. Attach each connector to the appropriate location at the rear of the display unit.

4. Pass cables through the slit on the boot cover.
5. Install the rubber stopper to each cable. The largest hole is for the DVI-D cable.

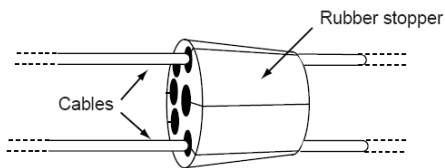

6. Use the four plate screws (M3x10, supplied) to fasten the fixing plate and boot cover to the display unit.

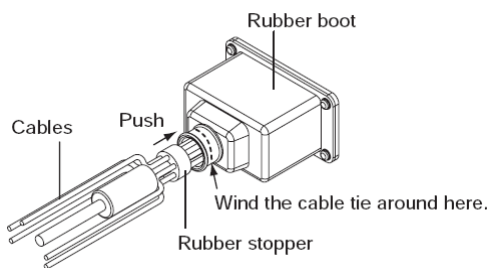

7. Slide the rubber stopper into the hole of the rubber boot, and fasten the cable tie to hold the rubber boot and stopper.

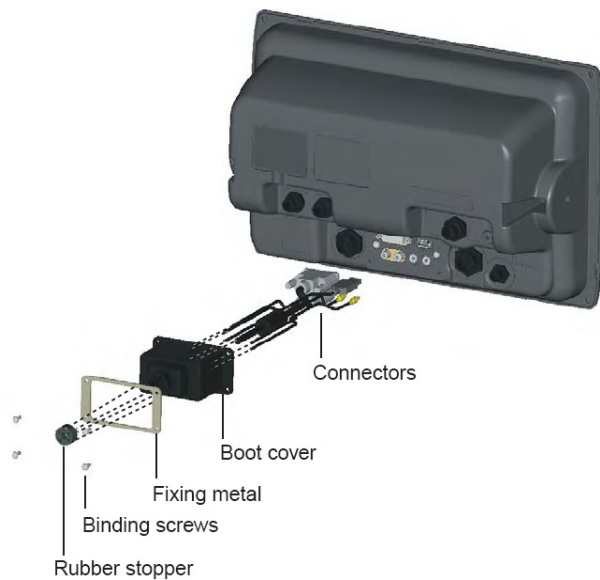

Note: When only the Ethernet, Power, DRS, DATA1, DATA2 and NMEA2000 connection are used the Waterproof Connector boot is not necessary.

2.10.2. Non Waterproof connection

When you do not need waterproofing, use the cable fixing plate (supplied in standard installation materials).

1. Unfasten the four screws to detach the connector cover at the rear of the display unit.

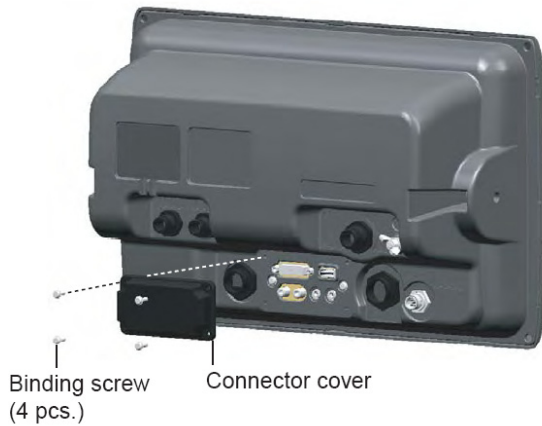

2. Attach the cable fixing plate by using the binding screw (M3x10, supplied as the installation materials).

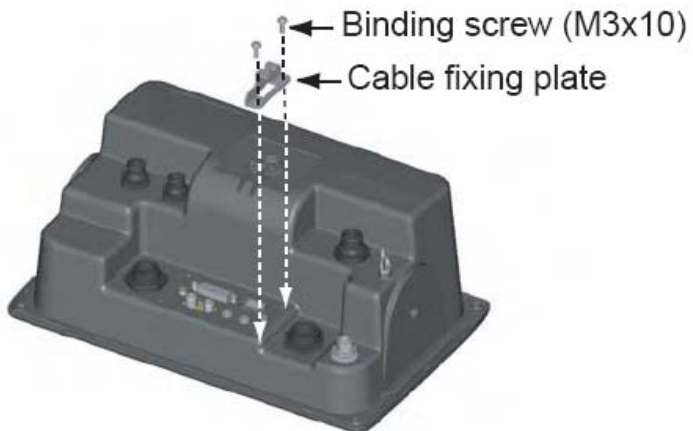

3. Attach each connector to the appropriate location at the rear of the display unit.
4. Wind the cable tie (supplied as the installation materials) to fix the cables to the cable fixing plate.

3. Configuration

3.1. Introduction

NavNet3D (just like NavNetVX2) uses Ethernet to share radar/sounder images and other navigation information from devices connected within a networked system. In any single NN3D network, a combination of up to ten NavNet3D MFDs may be connected to each other via Ethernet. All NavNet3D Network Components have an integrated regular RJ45 Ethernet port for this purpose. Legacy NavNet components such as the ETR-6/10N (FUSA P/N= BBFF1) or ETR-30N (FUSA P/N= BBFF3) network sounders will need to be connected using the Hub Adapter Cable 6Pin to RJ45 (FUSA P/N= 000-144-463).

This chapter shows you how to set up your NavNet3D system. Most of the configuration will be done using the Installation Wizard that is automatically launched during the first start up or can be manually launched by pressing the [MENU] key and selecting “System” then “Installation Wizard”. Before trying to configure a NN3D system, make sure that any and all instruments are correctly interfaced. Please refer to the previous chapter (Wiring) for more information.

On the MFD8/12, the initial configuration is done using the Cursor Pad (upper pad) and the Center click (which emulates a left click mouse).



On the MFD8/12, a generic **USB mouse connected to one of the USB ports is required** to perform the initial configuration.

Properly designing the layout of a NavNet3D network is key to a successful installation: read carefully the following Chapters and refer to the appendix for Installation examples.

3.1.1. Which MFD should be set as Master?

When multiple MFDs are connected in a network, one MFD (and only one) needs to be designated as the “Master”. The MFD set as Master will act as a DHCP server and automatically performs the network configuration of all the other MFDs in the network. (The Master sets up the Hostnames, IP addresses etc...).

Note: The notion of “Master” and “Slave” is only an installation setting for internal configuration, in other words, the MFDs set as “Slaves” do not have fewer features than the “Master”. All MFDs will function and operate similarly.

When choosing the MFD that will be designated as the Master, keep this in mind:

- The Master should be the MFD that will be used primarily (be turned ON all the time when using the system).
- It is recommended (but not necessary) to have as many instruments as possible (NMEA0183, NMEA2000) connected directly to the Master.
- When MFD8/12 and MFDBB are used, the MFDBB will be more likely to be configured as the Master in a given network (primary MFD) with the Radar Antenna directly connected to it (on Ethernet port 3).

Note: In a single MFD installation (only one MFD in the network), this MFD must be configured as the “Master”.

Please refer to Paragraph 3.2 for explanation on How to set up a Master

3.1.2. Data Source Selection

In a network installation (and even in a standalone system), multiple sensors can provide the same information (i.e.: Sounder and Smart Sensor can both provide depth information). NavNet3D allows you to select for each type of data, (Position, Depth, Temperature, and Heading...) the sensor that will be used as a primary source. In addition, if the primary sensor fails, and if another sensor providing the same information is detected on the network, NavNet3D will automatically switch to the other source after giving you an alert.

3.1.3. Installation Wizard Conceptual Description

The Installation Wizard is divided into sections (Tabs) that are targeted to configure specific aspects of the system:

“Own Setting” Tab

This Tab configures the local ports of the MFD (NMEA0183 Input/Output, NMEA2000 Output) on which the Installation Wizard is currently used.

“Global” Tab

This Tab contains configuration information that is global to the system and shared among MFDs. This is the section where the Data Source (Sensors) can be selected to be used as primary information. You will be able to customize sensor names (ex. Assign Location Nicknames) that will help you configure the system.

This Tab will also allow you to enter vessel’s specifications (size, Engine configuration...)

Note: It is recommended to perform the Global Configuration from the MFD set up as Master

“Sounder” Tab

When a Network Sounder is detected, this Tab will appear and allow you to configure your sounder module. NavNet3D is compatible with the Airmar Transducer ID protocol. This feature enables compatible transducers to transmit important data to the DFF1 or DFF3, including transducer model, functions, frequency, power rating, beam pattern, impedance, ceramic element configuration and acoustic window material. Through this Transducer ID feature, the DFF1 and DFF3 Sounder Modules will automatically know the connected transducer’s precise frequency, operating power and impedance, so it can “tune” its operation to automatically adjust and optimize echo sounder performance.

“Radar” Tab

When a DRS (Radar) is detected, this Tab will appear and allow you to configure your Radar and perform the Heading Alignment adjustment, Radar Optimization and Main Bang suppression

3.2. Master Setting and initial configuration

- Press the power switch of the MFD you want to designate as Master to power it ON. After few minutes, the Installation Wizard starts.

Note: The start up time of NavNet3D will be shorter once the system is fully configured.

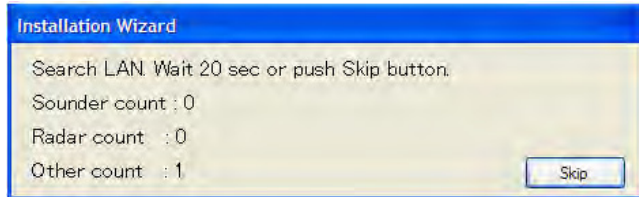

- The system will search for sensors on the network. At this time you can skip the search since no master is configured yet. Press on the “Skip” button

- If the MFD has factory default setting, the language selection screen appears. The default language is English. Use the Cursor Pad and the center click (or the USB mouse for the MFDBB) then click on “Next”:

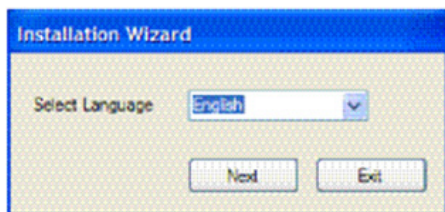

- On the Master Selection window that just appears, select Master = ON and press “Save and Exit”

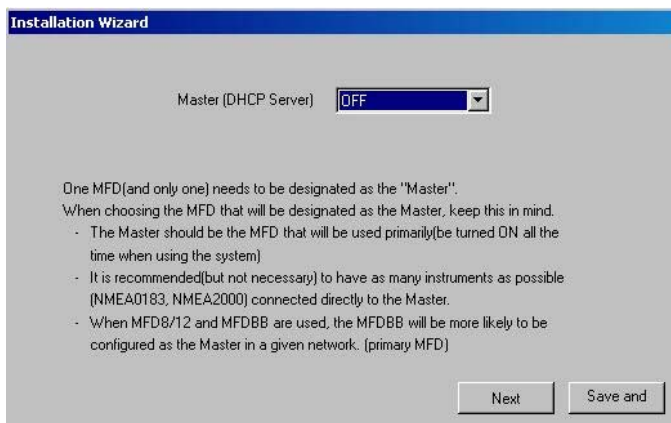

- Wait for the MFD to completely turn OFF (the MFDBB will restart then power off, be patient!)

Note: A “No Master Warning window” can appear to inform you than a Master is not yet configured. If this is the case, simply click on “Installation Wizard” to configure the Master.

Note: If the Master Selection does NOT appear, this means that there is already a MFD set as a Master on the network. If you want to change the Master setting to another MFD, you will have to turn the Master setting to OFF (on the MFD that is currently the Master) and restart the system to turn the Master ON on another MFD.

- When the MFD turns OFF (after being set up as a Master), make sure that every other MFD in the network are turned OFF and correctly wired to the HUB.
- Turn ON the Master MFD, then every slave on the network. Make sure that the LED on the HUB shows good traffic information (for the MFD, DFF1, DRS...)
- The Installation Wizard launches on every MFD and begins to scan the devices available on the network. Do not click on Skip. This will allow the scanning process to end normally.

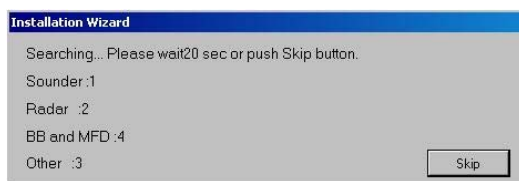

Note: If the Installation Wizard doesn't launch on the MFD, go to the [MENU] then “System” and select “Installation Wizard”.

- During the Installation Wizard countdown make sure that all MFD(s) see the Radar and Sounder (if you missed the countdown, look for the Radar and Sounder tab in the Installation Wizard: if they appear, radar and sounder are correctly detected).

Note: If the Radar and Sounder are not available on one MFD, you will need to troubleshoot the Ethernet connections (cables). Power OFF the MFD, make sure the connections are OK, repower the MFD and launch the Installation Wizard (and make sure it sees the Radar and/or Sounder).

Important: If you are using an MFD BB, the Keyboard will not work until it is properly “Linked” to a processor unit. Please refer to the paragraph “

MFDBB Keyboard/Processor Linking” p.61 to properly link the MFDBB keyboard at this time

When the Radar and Sounder (if applicable) are correctly detected, you can continue the installation on the Master MFD.

3.3. Installation Wizard Own Settings

3.3.1. Monitor (MFDBB only)

On the MFDBB, you can set up the video output resolution (DVI or VGA). Leave it to Auto when you use a Furuno monitor.

You can also set up the Clone or Extended mode

Note: If only one monitor is connected to the MFDBB, leave the setting to “Clone”

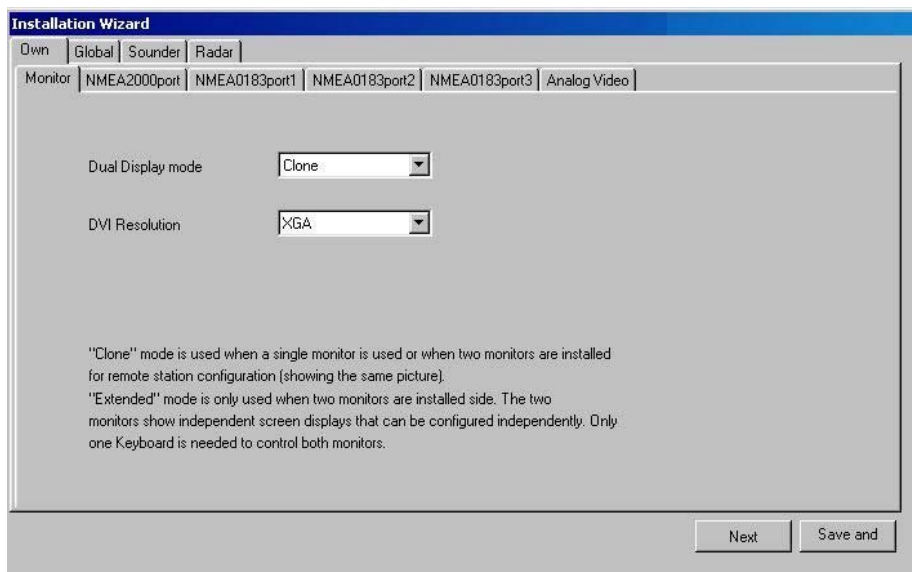

Please refer to the “External Monitors” paragraph on p.32 for more information on Clone and Extended mode when two monitors are connected to a single MFDBB processor.

3.3.2. NMEA2000 Data Configuration

This page configures the information that the MFD will output on its own NMEA2000 port. The information embedded in the PGN will be the information coming from the Sensor that will be chosen as the Primary Source (see next paragraph). Enable each NMEA2000 Data PGN that will be sent through the individual MFD’s NMEA2000 port.

Note that in a multi-MFD network, each MFD's NMEA2000 backbone is separate and independent. Therefore, you may have to perform the same procedure on each MFD where external NMEA2000 displays (i.e. FI-50, etc...) or sensors are connected.

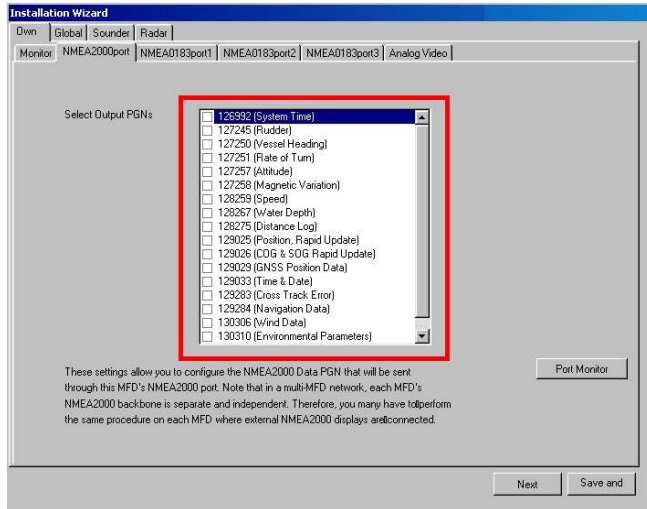

Note: This setting only configures the NMEA2000 Output Data. The NMEA2000 data received (Input) at each MFD and DRS is global and automatically recognized by the network. Each NMEA2000 Data Source at each MFD will automatically appear and may be selected as a Primary System Data Source.

Click on the “Port Monitor” button if you want to make sure that the NMEA2000 devices are correctly seen by the MFD

The list of every NMEA2000 devices connected to the MFD will appear at the top of the window. Simply select one device (by clicking on the line) and choose a tab (Receive PGN List or Transmitted PGNs) to have more information on a specific device.

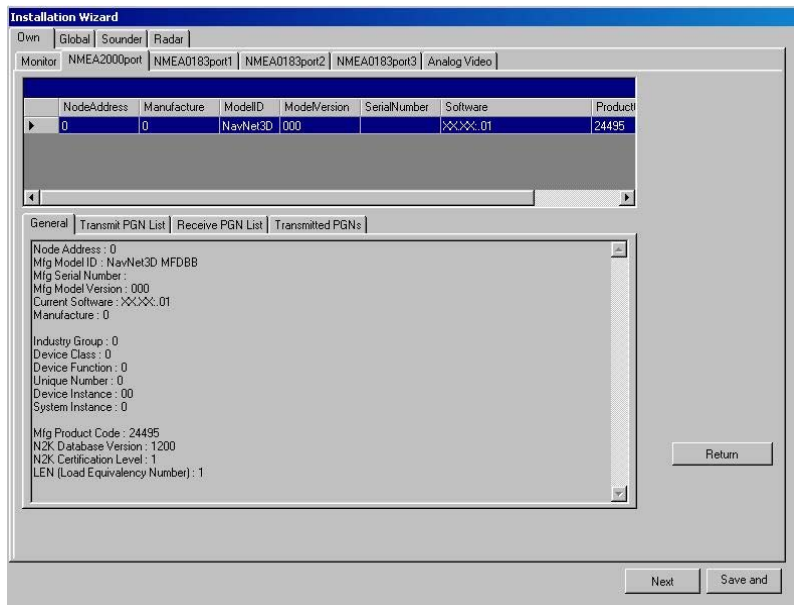

On the “Transmitted PGNs”, you have to click on “Stop” before expanding and viewing the incoming information

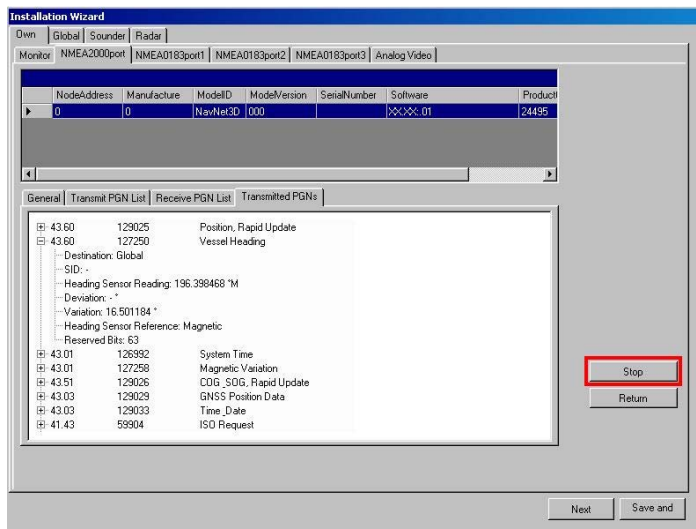

Click on the “Next” button to continue the configuration.

3.3.3.NMEA0183

The three “NMEA0183 Port” tabs are used to configure the Input and Output of the individual MFD’s own NMEA0183 ports. It is important to understand that it is not possible to filter any received NMEA0183 Data at any of these ports on individual MFDs. And unlike the automatic recognition capability with NMEA2000 Data sources, it

is instead necessary to manually specify or declare the specific type of NMEA0183 sensor that is interfaced to the each NMEA0183 Input Port.

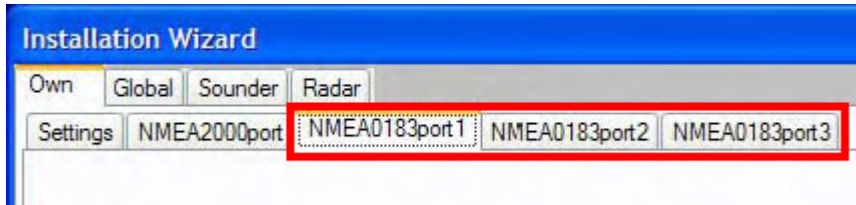

In these Tabs, you will have to configure the NMEA0183 Output Port specification (Version, Baud rate...) and the sentences needed to be output. You can also give a Nickname to the NMEA port (for example “Heading” or “Primary GPS”)

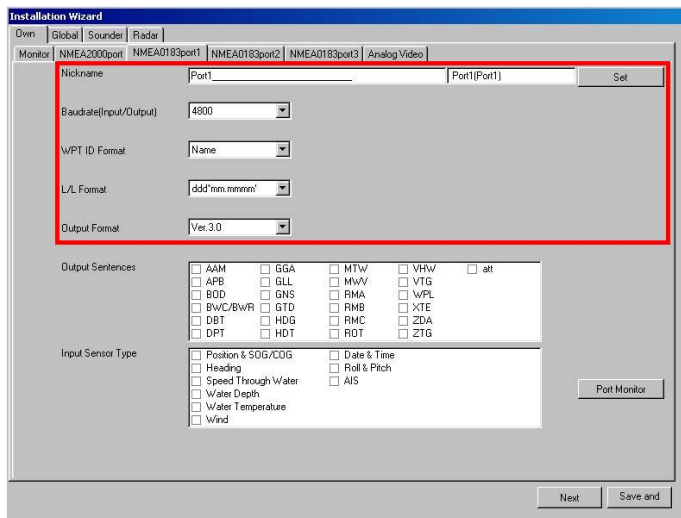

Note: “WPT ID Format” allows you to select, if the name of the WPT or the WPT sequence number is transmitted to an Autopilot.

The “L/L format” dialog box, allows you to choose how many digits (seconds) to display after the decimal point in latitude and longitude of the position sentences.

Next, you must declare the type of NMEA sensor(s) connected to the corresponding NMEA0183 Input Ports on the Master MFD. This information will be used in the Global Data Source Tab for selecting the Primary System Data Sources.

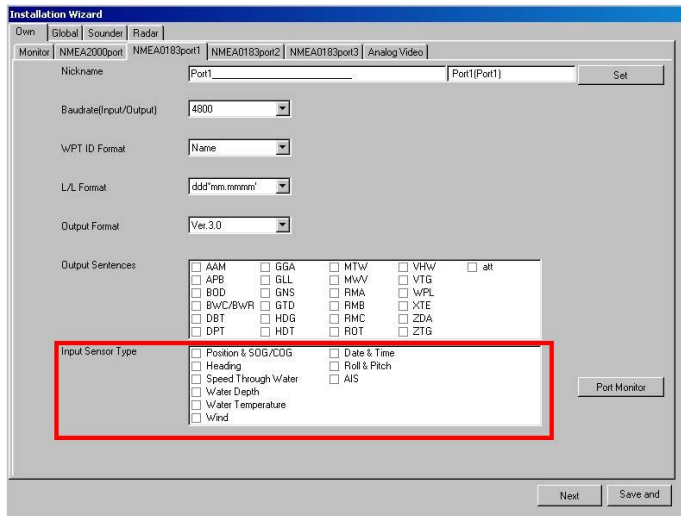

Example: If you connect a sensor such as a PB100 which provides Wind information but also Position, you will have to check “Position & SOG/COG” as well as “Wind”. You can click on the “Port Monitor” Button to make sure that the sensor is correctly sending the corresponding Data.

When you connect a GP320B (FUSA P/N= BBWGPS) to NMEA Port 1, a “Page 2” button automatically appears in the lower right corner of the page. Click on this button to configure advanced settings of the GP320B.

Name	Description
<p>POS. Smoothing</p>	<p>When the receiving condition is unfavorable, the GPS fix may change, even if the vessel is stopped. This change can be reduced by smoothing the raw GPS fixes. A setting between 000 to 999 is available. The higher setting the more smoothed the raw data, however too high a setting slows response time to change in latitude and longitude. This is especially noticeable at high ship’s speeds. Increase the setting if the GPS fix changes.</p>
<p>SOG/COG Smoothing</p>	<p>During position fixing, ship’s velocity (speed and course) is directly measured by receiving GPS satellite signals. The raw velocity data may change randomly depending on receiving conditions and other factors. You can reduce this random variation by increasing the smoothing. Like with latitude and longitude smoothing, the higher the speed and course smoothing the more smoothed the raw data. If the setting is too high, however, the response to speed and course change slows. For no smoothing, enter all zeroes.</p>
<p>Disable Satellite</p>	<p>Every GPS satellite is broadcasting abnormal satellite number(s) in its Almanac, which contains general orbital data about all GPS satellites, including those which are malfunctioning. Using this information, the GPS receiver automatically eliminates any malfunctioning satellite from the GPS satellite schedule. However, the Almanac sometimes may not contain this information. If you hear about a malfunctioning satellite from another source, you can disable it manually. Enter satellite number (max. 3</p>

	satellites) in two digits.
INIT. Position	Set initial latitude/longitude position for cold start.
ANT. Position	Enter the GPS antenna positioning bow-stern and port-starboard position.
ANT. Height	Enter the height of the GPS antenna unit above sea surface.
Rx Mode	Choose position fixing method: 2D (three satellites in view), 2D/3D (three or four satellites in view whichever is greater).
WAAS Mode	Select ON to use the WAAS mode.
WAAS Search	WAAS satellite can be searched automatically or manually. For manual search, enter appropriate WAAS satellite number.
WAAS Alarm	When the WAAS signal is lost, the audible alarm sounds one of two ways. On: Alarm sounds continuously until the WAAS positioning mode is available again or the alarm is acknowledged (by key operation). Off: Alarm sounds three times.

IMPORTANT: After configuring any NMEA0183 Input Port Sensors on the Master MFD, you must REPEAT THIS PROCEDURE on any other Slave MFDs in the network where you have connected NMEA0183 Input Sensors!! If this is not done, the sensors will not be available for selection as a Primary System Data Source in the Global Settings Tab.

-Click “Next” to continue the configuration

3.3.4. Analog Video

The Analog Video input can be renamed in this page. These names will be used by the RotoKey and for the Video ID in the main interface.

On the MFDDB, four Analog Video inputs are available and can be either set to NTSC or PAL format.

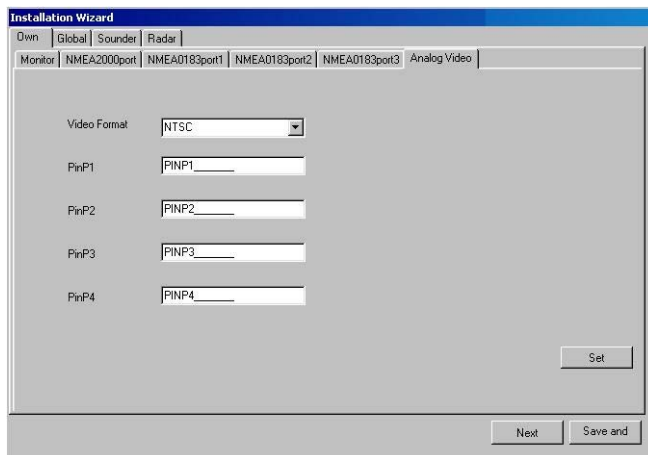

The MFD8/12 has two Analog Video inputs and the format detection (NTSC/PAL) is automatic

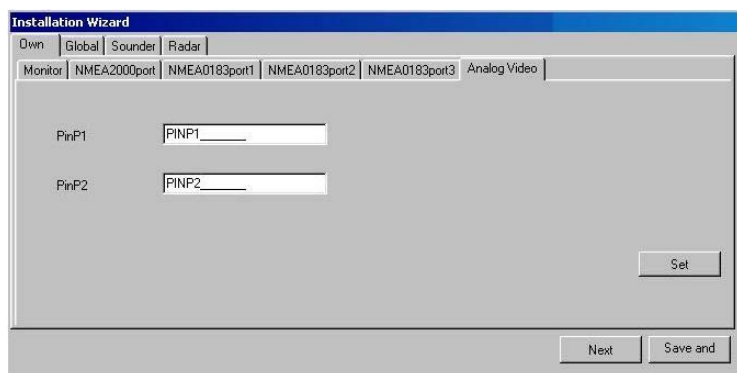

Note: The Analog Video inputs are only available on the MFD where they are connecting to. Unlike the IP Camera, these video feeds are not available on the network

3.4. Installation Wizard Global Settings

Usually, the Global Settings are performed from the Master MFD in the network.

3.4.1. Boat Parameter Settings

First, choose the unit you want to use to enter the boat dimension, and then enter the dimensions in the appropriate fields.

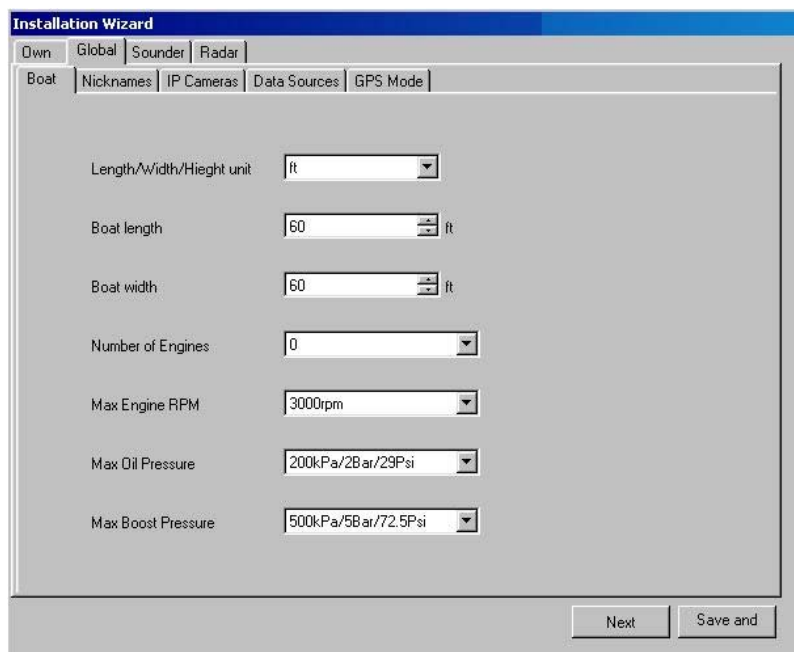

When an Engine(s) with a NMEA2000 Port is connected to an MFD in the network, the Maximum Value of the RPM, Oil and Boost pressure needs to be set up in order to correctly adjust the scale of the Analog Engine Gauges.

Note: Currently accepted engine data is as follows:

- Engine Parameters (PGN 127488)
 - Engine Speed
 - Engine Boost Pressure
- Engine Parameters (PGN 127489)
 - Engine Oil Pressure
 - Engine Temp
 - Engine Temperature Status
 - Engine Warning Status
 - Fuel Flow

3.4.2. Assigning Nicknames

You can assign Nicknames to every Ethernet Sensor, NMEA2000 instrument and NMEA0183 Receive Port for every MFD in a network. This will help you remember locations and assign the sensors designated as the Primary System Data Source during the next step.

In order to enter new names, the use of a USB keyboard is required. After assigning new names on the left column, don't forget to push the "Set" button (lower right) in order to validate the new names.

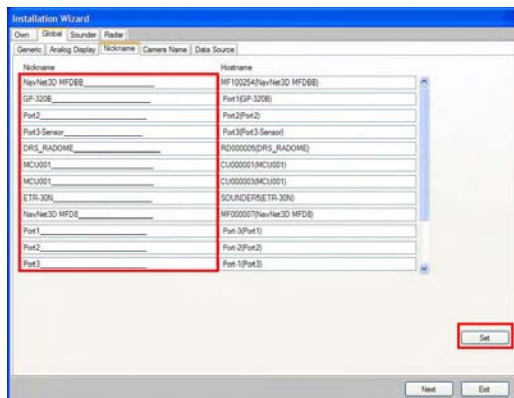

Note: If you have not renamed the NMEA0183 ports from their own tab, this page will display the NMEA0183 Input Ports of every MFD connected to the network as "Port1", "Port2" and "Port3". Each port refers to the MFD listed just above.

3.4.3. IP Camera

You can assign names to each connected IP Camera. These names will be used by the RotoKey and for the Video ID in the main interface.

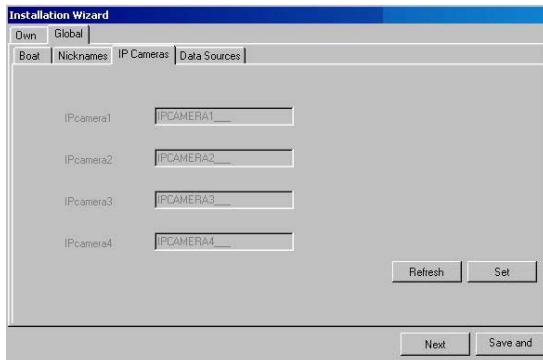

Note: If the IP camera selection is unavailable, make sure that it has a correct IP address (Refer to the Appendix “Configuring AXIS IP Camera”)

3.4.4. Primary Data Source selection

IMPORTANT: As explained in the “NMEA0183” p.47, if you have NMEA0183 sensors connected to the input ports of MFD(s) on the network, you first need to configure the “Own” settings for each MFD(s) before being able to select the corresponding instruments as a data source.

Select the “Data Source” Tab. This tab allows you to select the Primary System Data Source for various data types used by the Navnet 3D Network. Make sure to press the “Refresh” button (on the lower right corner) before configuring the source to make sure that all the source are scanned and available in each pop-up menu.

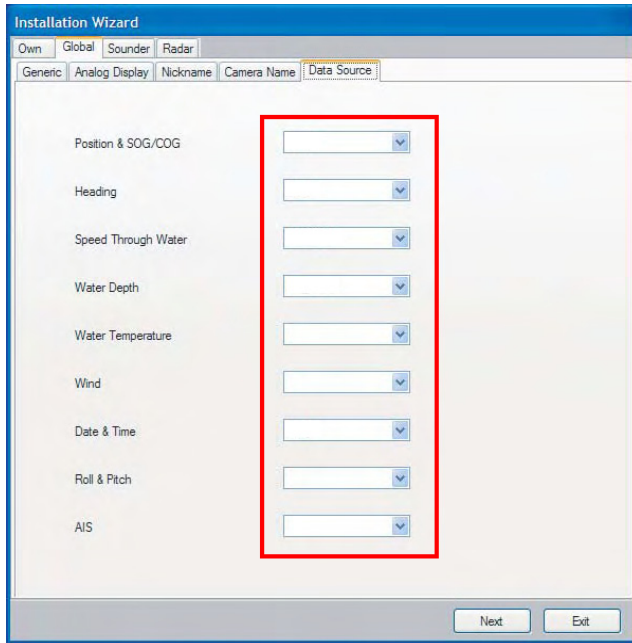

3.4.5. GPS Mode

The “GPS Mode” tab appears when a GP330B or WS200 (NMEA2000 sensors) are connected. This tab allow you to set up the WAAS Mode

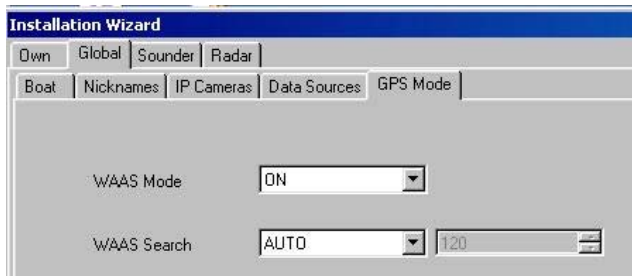

Name	Description	Example
Position & SOG/COG	Choose the position-fixing sensor to use.	GP-320B, GP-330, SC30, Generic NMEA2000 GPS
Heading	Choose the heading sensor to use	SC-30, SC-50 (@10Hz), PG-500 (@10Hz), Generic NMEA2000 Heading sensor
Speed Through Water	Choose the speed (STW) sensor to use.	Smart sensor (NMEA 0183 or NMEA2000), Transducer with Speed sensor (DFF1/DFF3)
Water Depth	Choose the depth sensor to use.	Smart sensor (NMEA 0183 or NMEA2000), DFF1, DFF3
Water Temperature	Choose the temperature sensor to use.	Smart sensor (NMEA 0183 or NMEA2000), Transducer with Temp sensor (DFF1/DFF3)
Wind	Choose the wind sensor to use.	FI-501/502, PB-150, WS-200, Generic NMEA2000 wind sensor
Date & Time	Choose the date and time source to use.	GP-320B, GP-330, SC30, Generic NMEA2000 GPS
Roll and Pitch	Choose the motion sensor to use.	SC-30, SC-50, SC110
AIS	Choose the AIS equipment to use	FA-150, FA-30, FA-50, Generic NMEA0183 AIS

Note: If a NMEA0183 Instruments does not appear as a selection in the list, make sure that the Input Type was correctly connected and assigned at each MFD (in the “Own” configuration) then press on the “Refresh” button Please refer to the “NMEA0183” paragraph p.47.

Note: Generic NMEA2000 instrument will appear as a selection for any type of data. Select the correct Data Source or leave the default selection (“Select...”) if no other instruments are available.

-If you don't have any DRS (Radar) and Network sounder click on “Save & Exit” to finish the installation. If you have a radar or sounder, click on “Next” to continue the configuration.

3.4.6. Sounder Configuration

Up to 2 Network Sounders can be connected on the NavNet3D network. NavNet3D is compatible with the DFF1, DFF3, FCV1150 (limited operation), ETR 30 (BBFF1) and ETR60 (BBFF3).

DFF1 and DFF3

Select the DFF1 or DFF3 tab and select the Sounder Source:

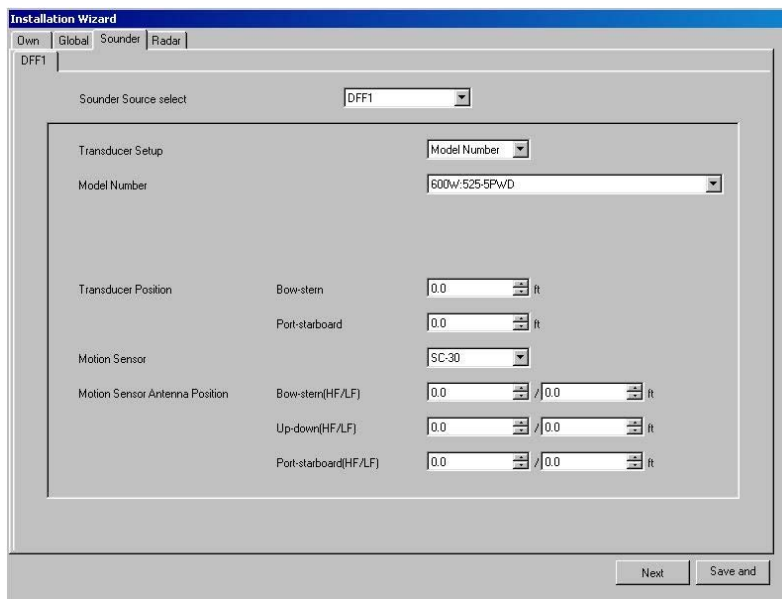
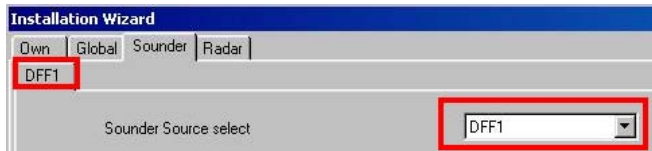

a) Transducer Setup:

If you have a TD-ID transducer, "TD-ID" will appear in the pull down menu and the settings (power and frequency) will be automatically adjusted.

If you don't have a TD-ID transducer, you can choose between "Model Number" (for Furuno Transducer only) and Manual (to manually set up the power and frequency).

b) Transducer Position:

For future use.

c) Motion Sensor and Motion Sensor Antenna Position:

If a Furuno satellite compass SC-30 or SC-50/110 is connected, set the distance

between antenna unit (or sensor) of the satellite compass and transducer (high frequency and low frequency) at the “Motion Sensor Antenna Position” pull-down menus.

Note: If a dual frequency transducer is used, the value for High and Low will be the same.

When entering the value, the point of origin is the antenna of the satellite compass.

Bow-stern: Set the distance from the satellite compass antenna unit to the sounder transducer (HF and LF). The value is positive when going toward the bow.

Up-down: Set the distance from the transducer to the antenna unit in the vertical direction (this value is always positive)

Port-starboard: Set the distance from the satellite compass antenna unit to the sounder (HF and LF). The value is positive when going starboard.

Example:

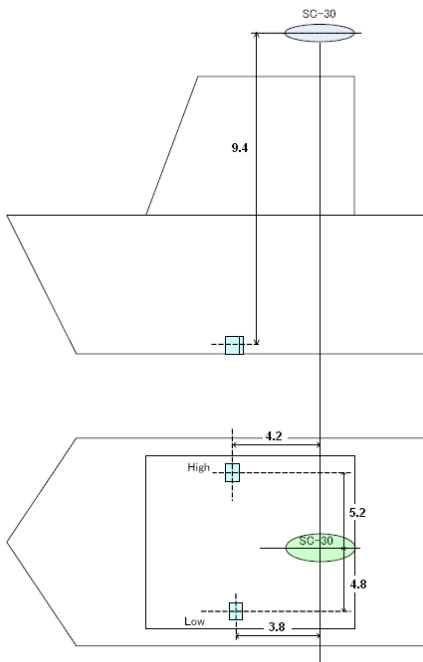

Motion Sensor		SC-30
Motion Sensor Antenna Position	Bow-stern(HF/LF)	4.2 / 3.8 ft
	Up-down(HF/LF)	9.4 / 9.4 ft
	Port-starboard(HF/LF)	5.2 / -4.8 ft

d) Temperature Source (DFF3 only)

If the DFF3 is equipped with a water temperature sensor, click the Temperature

Port pull-down menu, and choose the temperature source, MJ (NMEA0183 connector), High-frequency or Low-frequency.

IMPORTANT NOTE: The MFD8 and MFD12 cannot accept a decimal point in the frequency fields for this setting. Therefore, certain fields in this Setup Page must be typed using a multiplier of (x0.1). In other words, setting a frequency of 201.5 kHz must be typed as “2015” (2015 x 0.1=201.5). Setting a frequency of 52.3 kHz must be typed as “523” (523 x 0.1=52.3).

Note: For DFF3, set the tap setting in the network sounder after setting up all the MFDs. For details, see the Operator’s Manual of the DFF3.

ETR 30/60 (BBFF1/3)

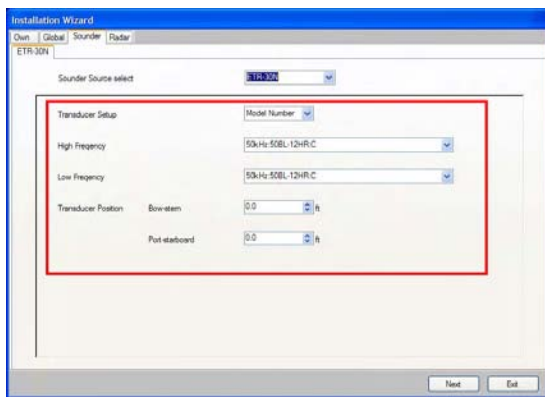

a) Transducer Setup:

You can choose between “Model Number” (for Furuno Transducer only) and Manual (to manually set up the power and frequency).

IMPORTANT NOTE: The MFD8 and MFD12 cannot accept a decimal point in the frequency fields for this setting. Therefore, certain fields in this Setup Page must be typed using a multiplier of (x0.1). In other words, setting a frequency of 201.5 kHz must be typed as “2015” (2015 x 0.1=201.5). Setting a frequency of 52.3 kHz must be typed as “523” (523 x 0.1=52.3).

b) Transducer Position:

For future use.

Note: Set the tap setting in the network sounder after setting up all the MFDs. For details, see the Operator’s Manual of your sounder

FCV1150

The FCV1150 must have version 3.01 software or higher to work in a NN3D system.

NavNet3D offers remote compatibility with the FCV1150. You will have to set up the FCV1150 for “NavNet Mode” from the System menu (start the FCV1150 while pressing the MENU key). Once the FCV1150 is in NavNet mode and connected to the NavNet network, it will appear as a selection in the Installation Wizard and in the Sounder Source menu of NN3D.

The sounder setups are done from the FCV1150 menu.

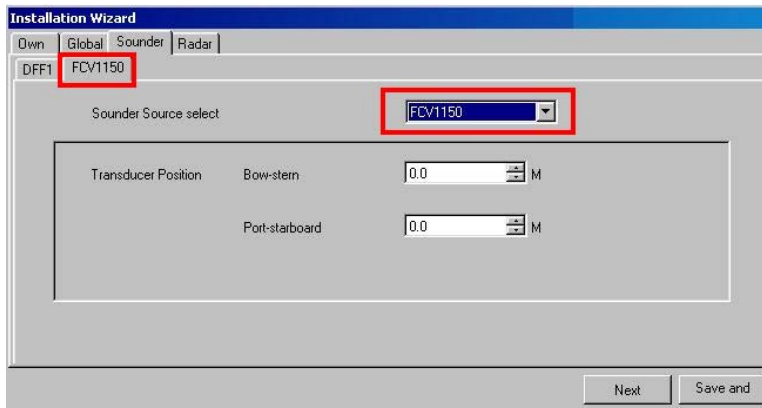

Transducer Position:

For future use.

Note: NavNet 3D offers limited control over the FCV1150. From NavNet3D, you can only control:

- *Range*
- *Shift*
- *Auto Mode (Cruising, Fishing, Manual)*
- *Auto Range*

If you don't have any DRS (Radar), click on Exit to finish the installation. If you have radar, click on “Next” to continue the configuration.

3.4.7.DRS (Radar) Configuration

Up to two DRS (or one DRS and one FAR21X7) can be connected on a NavNet3D network.

DRS

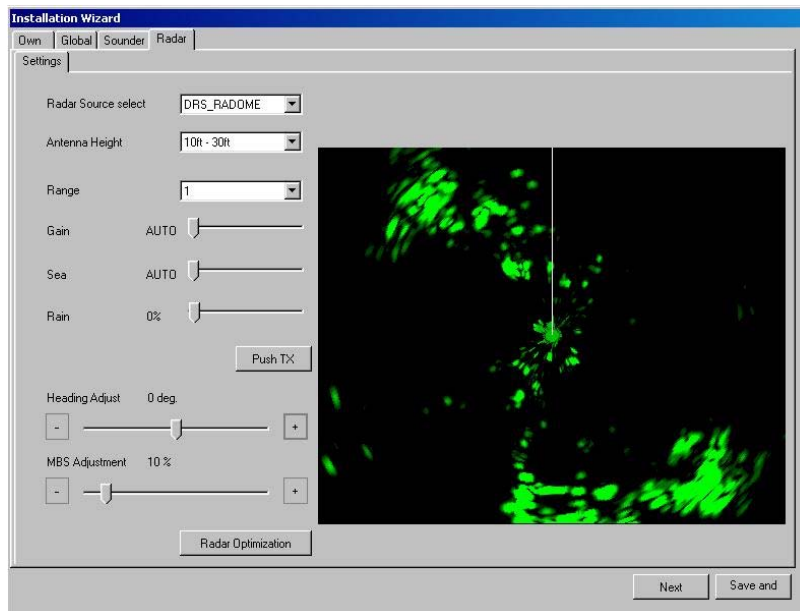

- Click the Antenna Height pull-down menu, and choose the height of the antenna above the waterline, under 10ft, 10ft-30ft or over 30ft.

- Push the TX button and adjust the range and the gain slider to have a clear picture
Recommended Settings:

- Range = 1
- Gain = AUTO
- Sea = Auto
- Rain = 0

- Click on "Radar Optimization" and wait 30 sec

- Perform the heading adjustment as follows:

- Steer towards a suitable visible target (for example, moored ship or buoy).
- Click the Range pull-down menu, and choose a range between 0.125 and 0.25 nautical miles.
- While the vessel is pointed at the target, turn the RotoKey or drag the Slide Bar to bisect the target with the displayed line.

- As a final test, steer towards a small buoy and confirm that the buoy shows up dead ahead on the radar when it is visually dead ahead.
- Perform the Main Bang Adjustment as follows:
The Main bang is the “black hole” which appears at the display center on short ranges. Select “MBS Adjustment” and rotate the RotoKey to suppress the main bang. After adjusting, push the RotoKey to validate.
- Push on STBY (to stop the antenna rotation)
- If you have another DRS, choose it from the “Radar Source Select” pull down menu and repeat the process

FAR21X7

No setup is required in the Installation Wizard for the 21X7 (setup is done from the 21X7 radar processor)

Click on “Exit” (make sure that the Radar is on STBY or the button will not be available).

Important: If you are using an MFDBB, the Keyboard will not work until it is properly “Linked” to a processor unit. Please refer to the next paragraph “

3.5. MFDBB Keyboard/Processor Linking

MFDBB Keyboards are Ethernet network devices that need to be assigned (linked) to a specific MFDBB processor unit during installation. A special “key-push” sequence is used to cycle through the “Linking Codes” for all the MFDBB processor unit(s).

If only one MFDBB processor unit is on the Network:

Simultaneously press and hold the Left key of the Scrolling Pad, the Right key of the Cursor pad and push the RotoKey for 5sec. (This intentionally requires two hands)



The Keyboard will beep two times. You can release the button at this time. The keyboard will now control the MFDBB.

Note: If this process fails, make sure that one MFD is set as Master on the network. Disconnect and reconnect the keyboard from the processor unit and try again.

If multiple MFDBB Processor Units are on the Network:

Make sure that all MFDBBs are ON. Repeat the process (as explained above) until two beeps are heard. Try to push the RotoKey and/or use the scrolling pad to see if the MFDBB you are looking at can be controlled with the current keyboard.

If the MFDBB does not respond (meaning that the keyboard is actually linked to another processor unit on the network), repeat the process until the keyboard controls the correct MFDBB processor.

Repeat this process to link the other MFDBBs to their Keyboards.

4. Registering the System

4.1. SystemID Description

The Navnet 3D SystemID is a unique number assigned to a complete NN3D networked system with one or more MFDs. On the same boat, all networked MFDs have the same SystemID. This number will not change if an MFD or other NavNet Component is added to the system. The SystemID is used to identify the customer when he purchases data or services. Note that the unique SystemID will be created automatically only when the system is set-up (when all MFDs are networked together and one Master is assigned).

To access the SystemID, press the [MENU] key on any MFD, turn the RotoKey to select the “My NavNet” page. The SystemID is the 20 digit number (beginning by “SI”) at the bottom of the page.

It is highly recommended to immediately write down the SystemID on the Furuno Registration Card.

4.2. Registration Card

A registration Card comes with every MFD. This Registration Card contains the Serial Number and the Registration Number that are required to correctly register the system online at www.navnet.com. Note that customers will not be able to purchase additional data and receive information about his system if the System is not properly registered online.

In order to register, the customer will need to enter the Registration Number of each MFD. It is also recommended to enter the SystemID at the time of registration

5. Checklist

5.1. Master

Make sure that one (and only one) MFD is assign as a Master on any given NN3D Network. You can check the status of every MFD (Master or Slave) by pressing the [MENU] key then scrolling down to the “My NavNet” menu page. “MFD Type” will indicate if the current MFD is a Slave or a Master.

5.2. Power Synchronization Configuration

The Power Synchronization signal can be seen as a “chain” that must NOT be broken. You break the chain if you use a 2-Pair Ethernet cable or if one DIP switch (in the HUB101 or BB) is set to OFF among the chain.

Note: The Power Synchronization signal is only used for powering ON the MFDs. The Shutdown is a software command and thus will work even if the DIP switches are set to OFF or if a regular hub is used.

Be sure to check the following:

Network Cable

Make sure that you use 4-pair Ethernet Cable to link all Power Synchronization compatible devices to the HUB101 or MFDBB. The Power Synchronization compatible devices are:

- Every NN3D MFD (MFD8, MFD12 and MFDBB)
- DFF1 and DFF3
- DCU12
- Radar PSU012 and PSU013

HUB101

When you want the Power Synchronization to pass, make sure that the DIP switch(s) are ON. When you are connecting a device that is not compatible with the Power Synchronization signal (BBWX1, computer...), make sure that the DIP switch(s) are OFF and/or that you are using 2-Pair Ethernet cable

MFDBB

Inside every MFDBB (NN3D BlackBox) there is a “mini” HUB101 with DIP switches. You will need to turn ON the dip switch inside the BB if you want the Power Synchronization signal to pass.

As a reminder, Port 1 and Port 2 on the BB are ONLY used to connect the MFDBB Keyboard(s). You can ONLY use port 3 and port 4 to connect Ethernet cables to the DRS, HUB101, DFF1, and other Ethernet devices.

On port 1 and 2 (reserved for the Keyboard), leave the DIP switch to OFF as the BB keyboard (MCU001) does not need the power synchronization signal.

DFF1/DFF3

The DFF1 has DIP switches that need to be set up differently if you use a regular hub or the Furuno HUB101 (with Power Synchronization).

For the DFF1:

- Regular HUB (no Power Synch.) = Dip switches are “Down-Up-Up-Down”
- HUB101 (Power Synch.)= DIP switches are all UP

For the DFF3:

- Regular HUB (no Power Synch.) = DIP switch 1 and 2 are set to ON
- HUB101 (Power Synch.)= DIP Switch 1 and 2 are set to OFF

5.3. Heading Input

If you connect a heading sensor to NavNet3D (using one of the NMEA0183 ports), the heading refresh rate needs to be 100ms (10 times per second = 10Hz or faster).

You can check the heading refresh rate using the port monitor of the MFD (in the Installation Wizard). To check the refresh rate, Clear the page and immediately start to count how many seconds are required to fill up the page. Count the number of HDG sentence and divide it by the number of seconds. This will give you an approximation of the refresh rate:

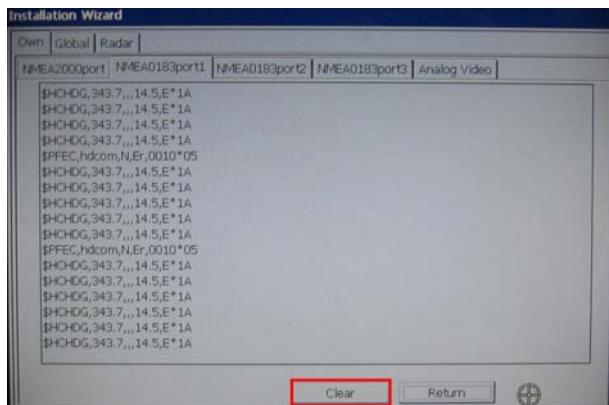

***Note:** Heading data from a NMEA2000 source/sensor will always be at the correct refresh speed for the DRS ARPA function*

5.4. NMEA2000 and NMEA0183 output sentences

Only output on the NMEA2000 and NMEA183 the sentences that are needed. Uncheck every output sentences if nothing is connected to the corresponding port. This will help you in the future confirm that nothing is connected to the port (without having to look physically on the back of the MFD).

Make sure also that you don't create any NMEA0183 data loop. For example, if a PB150 is connected to one port; do NOT output position information (GGA, GLL, RMC...) to this port (the PB150 will try to use this position information instead of its internal GPS and an alarm will result). Again, this can be avoided by only selecting the minimum sentences required by the device connected to the port.

5.5. Powering Sequence

Power ON:

While the Power Synchronization should turn ON all the MFD at the same time, it is recommended to power ON the system from the Master MFD.

If a regular Hub is used (without Power Synchronization), the MFD set as Master must be the first one powered ON.

Power OFF:

The system can be turn off from any MFD. To properly shut down an MFD, you have to release the Power Key just after the countdown reach 0. This will properly shut down the MFD (and the network). If you Hold the Power Key for 5 seconds (and don't release just after the countdown), you "hard shut down" the MFD.

When you hard shut down an MFD, the Power Synchronization will not work on this MFD until you shut it down properly. Understand that if you Hard Shut down the Master then power ON the system by pressing the Power button on a slave, the Master will not automatically power on, and every MFD slaves will display the "No Master Warning".

6. Appendix

6.1. Example NN3D System Configurations

6.1.1. Basic Plotter/Fish Finder Installation

The Furuno GPS (FUSA P/N BBWGPS) is directly connected to 7-Pin Port DATA1 of the MFD. The DFF1 Fish Finder (FUSA P/N DFF1) is directly connected to the Ethernet port of the MFD using the standard supply cable (3Meter). If the Ethernet connection needs to be extended, use a longer cable or add a LAN Coupler (FUSA P/N= RJ4-5CN-STR) with the following longer Ethernet Cables:

- 2 Meter RJ45 to RJ45 Ethernet Cable (P/N 000-167-175)
- 5 Meter RJ45 to RJ45 Ethernet Cable (P/N 000-167-176)
- 10 Meter RJ45 to RJ45 Ethernet Cable (P/N 000-167-177)

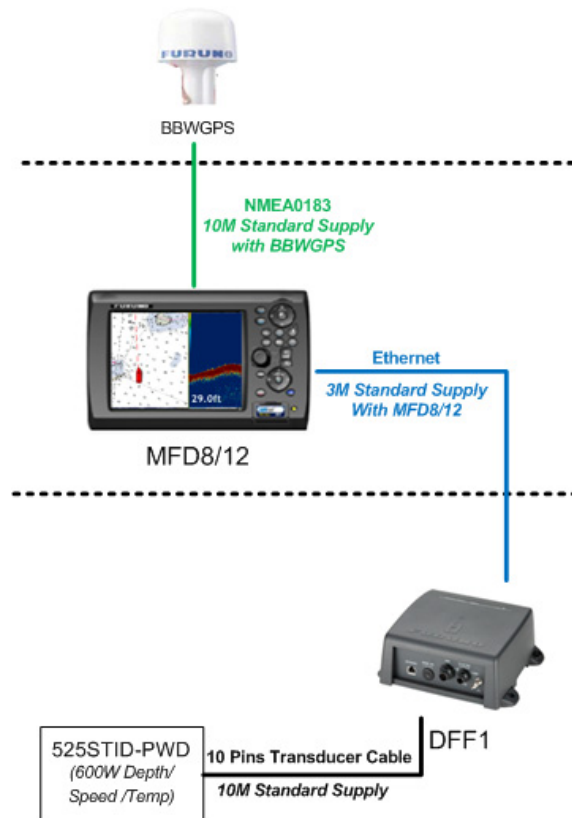

6.1.2. Basic Plotter/Radar/Fish Finder Installation

This is a single station Plotter/Radar/Fish Finder installation.

The Furuno GPS (FUSA P/N BBWGPS) is directly connected to 7-Pin Port DATA1 of the MFD. Since two Ethernet sensors are on the network (DRS Radar and Fish Finder), a network switch (FUSA P/N HUB101) is necessary. In this case the Radar power cable is directly connected to the back of the MFD8/12 (DRSxD (Domes) can be powered

directly by any MFD. For DRSxA (Open) check compatibility). The Ethernet side of the DRS Siamese cable may be extended using a coupler (FUSA P/N= RJ4-5CN-STR) and an Ethernet cable.

Optional Ethernet Cables that can be used:

- 2 Meter RJ45 to RJ45 Ethernet Cable (P/N 000-167-175)
- 5 Meter RJ45 to RJ45 Ethernet Cable (P/N 000-167-176)
- 10 Meter RJ45 to RJ45 Ethernet Cable (P/N 000-167-177)

-Note that the HUB101 and all MFDs have “AUTO MDX” Ethernet Ports. This means that they will automatically adjust for straight and cross-over Ethernet cables!

-Note that this installation will not allow Radar Overlay or ARPA target acquisition. If these functions are desired, a Heading Compass sensor such as the Furuno PG500/SC30/SC50 is required (see installation example on pg72)

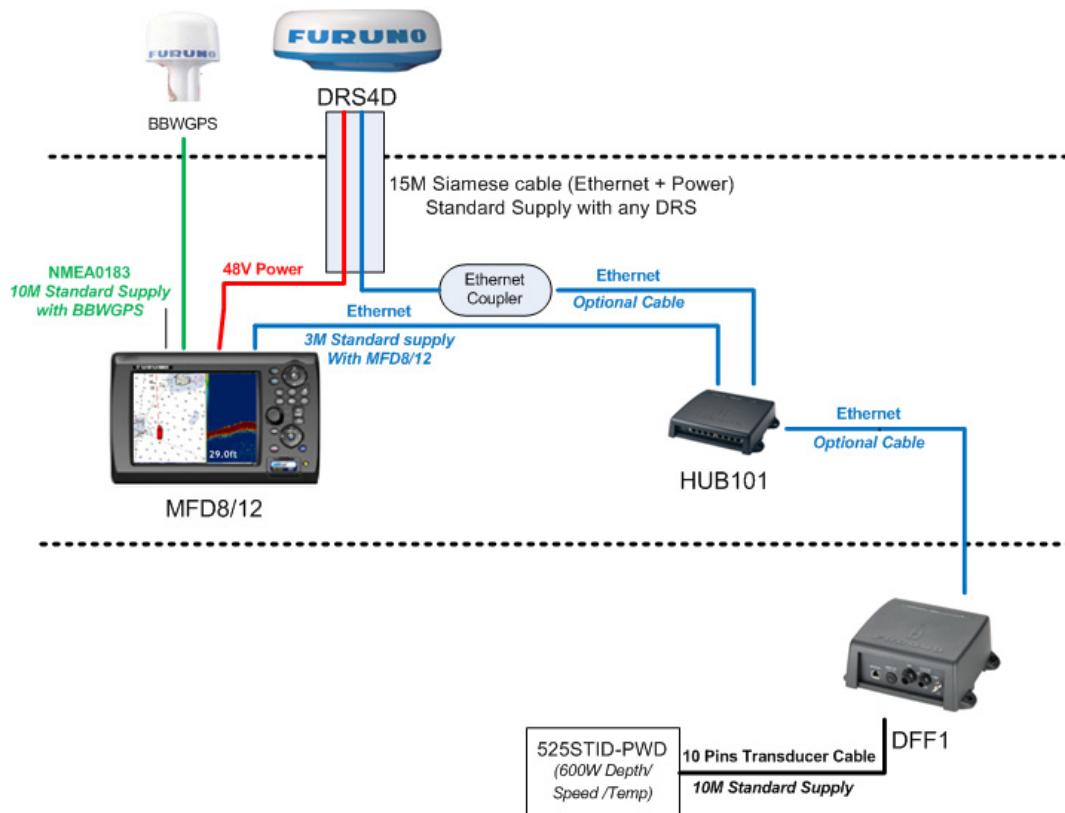

Additional Furuno Network Sensors can also be plugged directly to the HUB (using a regular Ethernet cable):

- FA30 AIS Receiver/FA50 AIS Class B Transponder
- BBWX1 Sirius Satellite Weather Receiver
- FAX30 - Weather Fax Receiver

6.1.3. Dual MFD Installation Example

This installation is a dual MFD installation with Radar Overlay and ARPA functionality (PG500 Heading Sensor included). The Furuno GPS (FUSA P/N BBWGPS) is directly connected to 7-Pin Port DATA1 of the MFD. The Furuno Heading Compass (FUSA P/N PG500) is connected to port DATA2 of the MFD.

Note that in this installation, the DRS is a 12kW “DRS12A” and therefore an optional power supply (PSU12) is required to supply power to the DRS12.

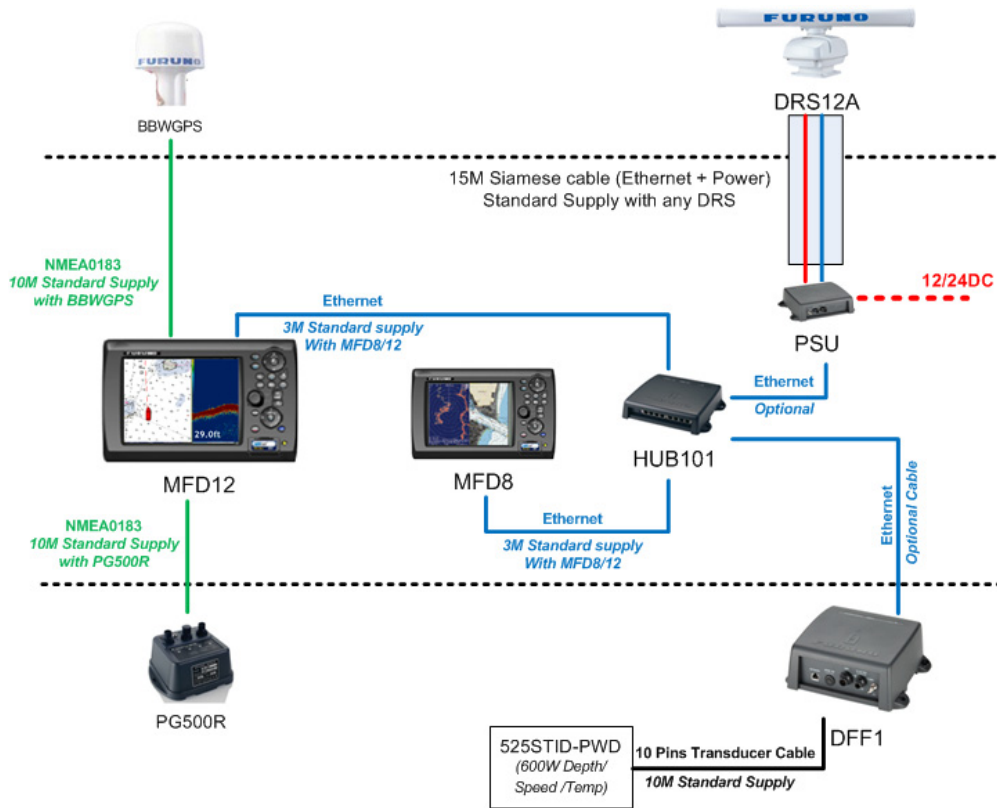

Additional sensors can also be plugged directly to the HUB (using regular Ethernet cable):

- FA30 AIS Receiver
- FA50 AIS Class B Transponder
- BBWX1 Sirius Satellite Weather Receiver
- FAX30 - Weather Fax Receiver

6.1.4. Dual Screen MFDBB Installation with Pilot Integration

Navpilot 500 Series Integration with NN3D MFDs is similar to Navnet vx2 integration. One difference is that NN3D MFDs no longer have an AD10 Heading Port. However, NN3D MFDs do require high speed NMEA0183 heading information (10Hz) for ARPA functionality.

Heading Interface to MFD:

To meet the High Speed Heading requirement, it is necessary to directly connect the output from the NMEA Port (Middle Connector) on the PG500 to one of the three NMEA0183 Receive Ports on a NN3D MFD. It is easy to make this connection by cutting and splicing the standard 6 pin-to-6 pin cable, that is supplied standard with the PG500, to either NMEA0183 Receive Port 2 or Port 3 on the DATA2 Cable of an MFD:

PG500	MFD DATA2 Pig Tail (NMEA Port3)
White	Blue
Black	Blue/White

Nav Data Interface to MFD:

The Nav Data connection to the Navpilot processor from one of the NMEA0183 Output Ports of the NN3D MFD is similar to that of Navnet vx2:

Navpilot Processor TB7 (NMEA In/Out)	MFD DATA2 Pig Tail (NMEA Port2)
Pin 1*	Brown
Pin 2*	Brown/White
Pin 3	Red
Pin 4	Red/White

**Note that this connection is only necessary if Rudder Angle Information is needed because an FI-50 series FI-506 Rudder Display is used on an MFD NMEA 2000 Backbone. In this case, make sure that ONLY the "RSA" Sentence is turned on from the software of the Navpilot System. If Rudder Angle is not needed, the receive port may alternatively be used to bring in the Heading Data from the PG500 or connection to another NMEA0183 transmitting device.*

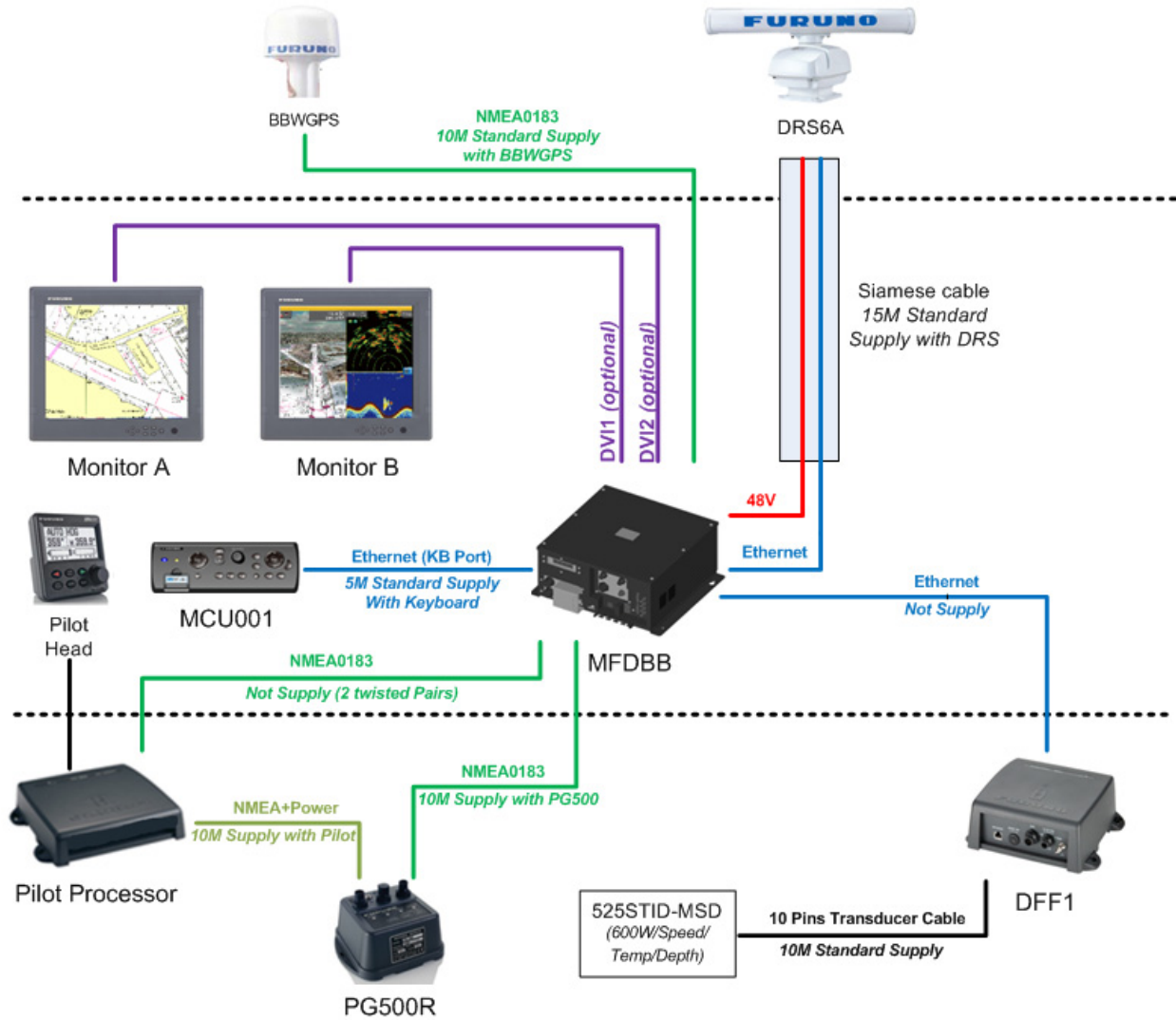

In the above example, the MFDBB is configured for Extended Mode. The two monitors show independent screen displays that can be configured independently. Only one Keyboard is used to control both monitors (the cursor will “jump” back and forth from monitor to monitor). The two screens need to be located in close proximity to each other.

Optional DVI Cables that can be used:

- 5 Meter DVI Cable (P/N 000-149-054)
- 10 Meter DVI Cable (P/N CBL-DVI-10M)

6.1.5. Dual Screen MFDBB with DRS and FAR21X7

This installation is a simple dual radar installation (one DRS and one 21X7). Note that the SC30 is directly plugged into the CANBUS port of the DRS (it provides accurate heading and position to the system). The 21X7 processor is simply connected to the HUB 101 (with DIP switch OFF) through its Ethernet port

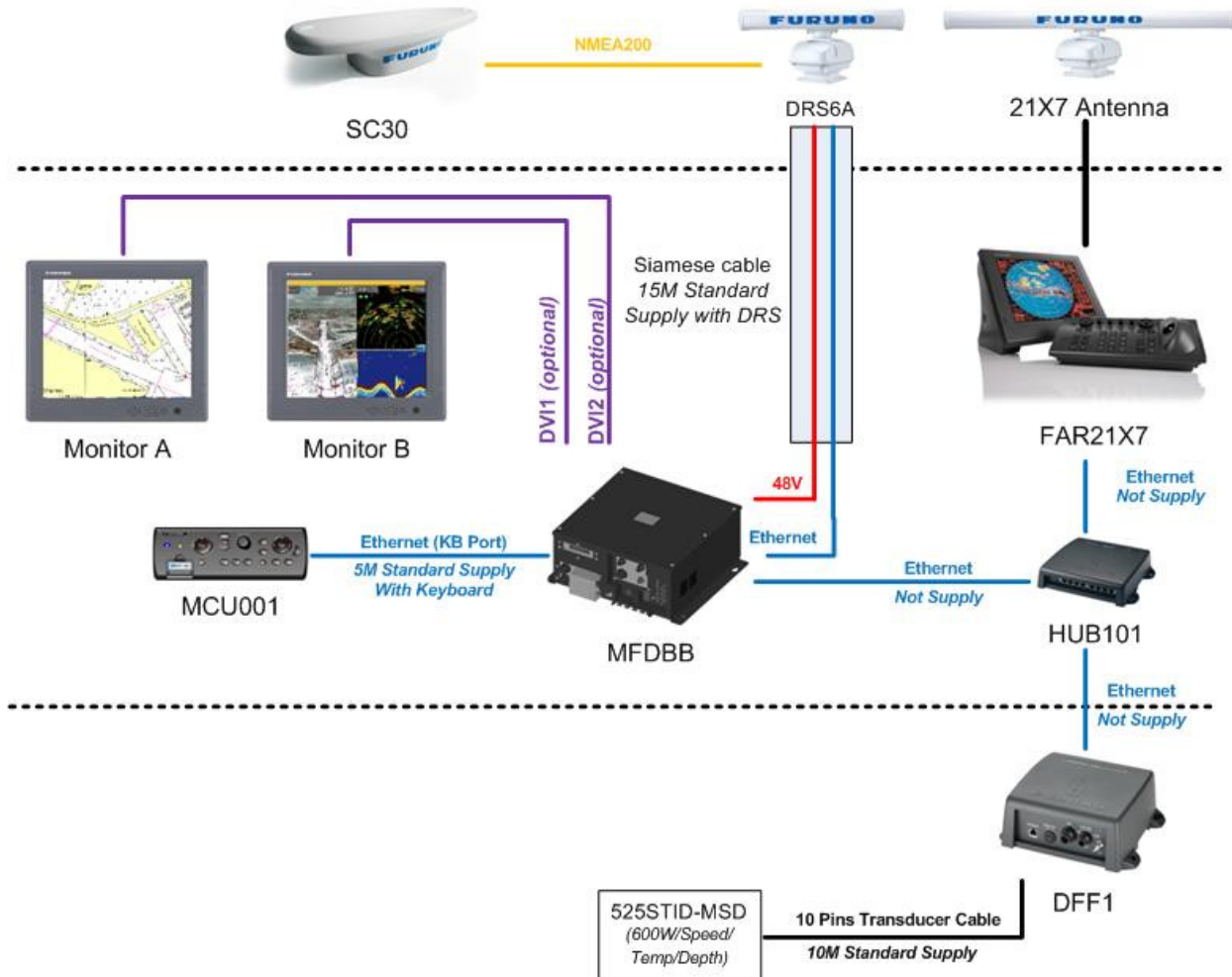

6.2. Master Reset

6.2.1.MFDBB

A USB keyboard is needed to perform a Master Reset on the MFDBB

Note: The USB Keyboard needs to repeat the key command when the corresponding key is held. Some keyboards (such as wireless keyboard) will not be able to reset the MFDBB

- 1) Disconnect any network device (only connect one MCU001 Keyboard controller)
- 2) If the MFDBB is on, Power it OFF by pressing the “Power” key of the MCU001 keyboard for more than 5 sec.
- 3) Make sure the USB keyboard is correctly plugged into one of the USB ports of the MFDBB
- 4) Turn ON the MDDBB. As soon as the last screen of the following sequence appears (NavNet3D logo on a blue and white cloud background), push and hold the ESC key until the MFDBB restarts automatically.



- 5) When the MFDBB restarts, you can release the ESC key. After approximately 1-2 minutes the MFDBB will power OFF completely
- 6) Re-connect the network and NMEA devices and power ON the MFDBB again. The Installation Wizard will start with the default factory settings.

6.2.2.MFD8/12

- 1) Disconnect any network device
- 2) Disconnect any NMEA0183 Instruments
- 3) If the MFD8/12 is ON, power it OFF by pressing the “Power” key for more than 5 sec.
- 4) Press and Hold the [CANCEL] key
- 5) Start the MFD and continue to press the [CANCEL] key
- 6) The Cursor will appear, continue to hold the [CANCEL] key until the Installation Wizard appears (approximately 1-2 minutes)
- 7) The MFD8/12 will not shut OFF (unlike the MFDBB) but the Installation Wizard should appear with the language selection (confirming the Master Reset)

6.3. Configuring AXIS IP Cameras

6.3.1. Introduction:

As of April 2009, the following MPEG-4 capable AXIS IP cameras are compatible with NN3D: 207 / 211 / 212PTZ / 216FD /215PTZ / 225FD / 233D

In order to view and control Axis IP Cameras from an MFD in a Navnet 3D network, it is first necessary to assign the IP Address of the AXIS IP Camera. This procedure will require a Windows PC connected via Ethernet to the AXIS IP Camera(s). Pre-wiring and installing the cameras on the vessel first is recommended so that all AXIS IP cameras can be networked to the PC through a Hub and can be configured at the same time. It will be necessary to setup the IP Address of the PC and use the AXIS IP Utility Program (Provided with the Camera) to configure the Camera's IP Address.

6.3.2. Setting the IP of the computer

Go to "Start" and select "Control Panel"



Open "Network Connections"



Right Click on "Local Area Connection" and select "Properties"

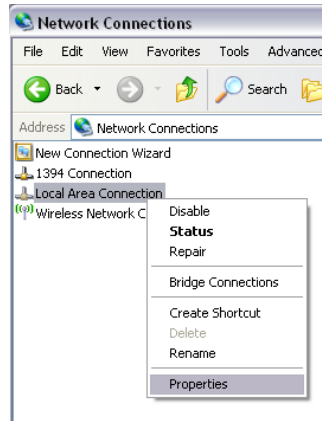

Select “Internet Protocol (TCP/IP)” and click on “Properties”

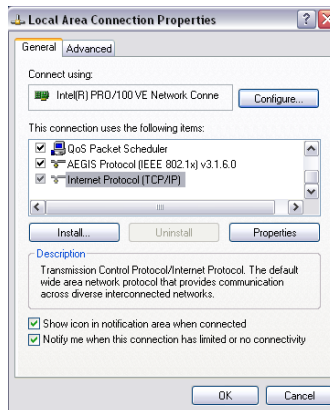

Fill the IP fields as shown below.

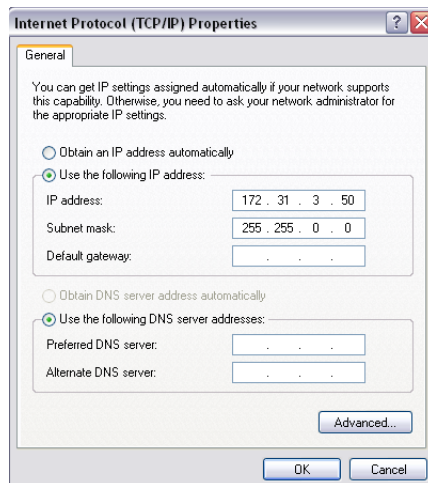

Click on OK to confirm and close the 2 windows.

Note that the new IP can take up to 20 seconds to be recognized. A pop-up in the lower right corner should show when the IP is correctly set. Turn OFF any Firewall that could

prevent data to be exchanged between NavNet and the PC. You may also have to restart your computer.



6.3.3. Set up the IP address of the camera

To work in a NavNet3D system, the IP cameras need to be set up with specific IP Addresses. Up to 4 IP cameras can be connected on a network.

IP Camera number 1 = 172.031.200.003

IP Camera number 2 = 172.031.200.004

IP Camera number 3 = 172.031.200.005

IP Camera number 4 = 172.031.200.006

In this example, we will set up 3 IP cameras:

- A moving IP camera (AXIS 212PTZ) that will be configured as IP Camera 1
- A non moving IP Camera (AXIS 207) that will be configured as IP Camera 2
- A non moving IP Camera (AXIS 207) that will be configured as IP Camera 3

Load the AXIS CD “Network Video Products” that was including with the IP camera. The Autorun software should appear (If the autorun is not working on your computer, browse the CD and double click on “Setup”)

Select “Install Product”



Click on “Copy to PC”



The following window should appear. Just double click on “IPUtility” to launch the configuration software

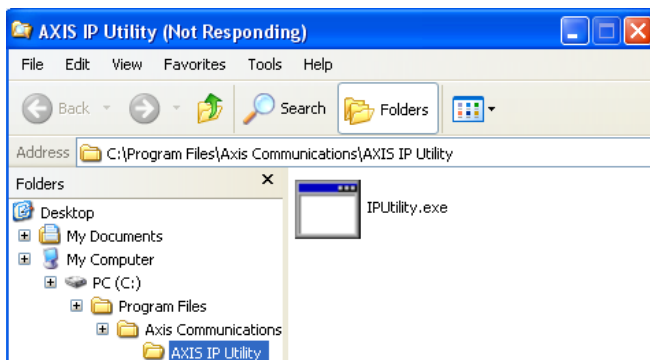

Note: If the Windows Firewall appears, click on “Unblock” to allow the software to configure correctly the IP Camera



The AXIS IP utility will detect all the IP cameras connected on the network

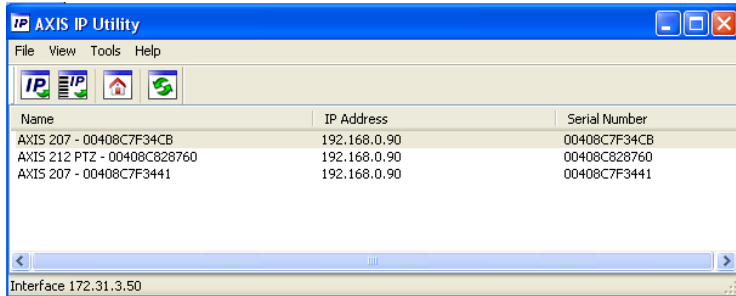

Note: If you use the same camera models in multiple locations, BE SURE to WRITE DOWN the IP Camera serial number (that can be found on the back of the camera) with the intended location to help correctly assign the IP camera's name.

In this example, we will assign a moving camera (212 PTZ) to IP Camera 1 (Deck), a non-moving camera with the SN ending with 34CB to IP Camera 2 (Engine Port) and a non-moving camera with the SN ending with 3441 to IP Camera 3 (Engine Starboard).

To change the IP address of the Camera, just select the camera in the list and click on the "assign new IP address to selected device" button

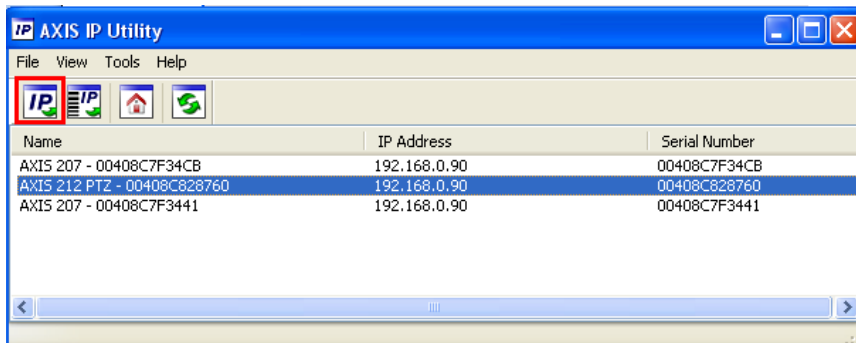

Enter the correct IP address and click on "Assign"

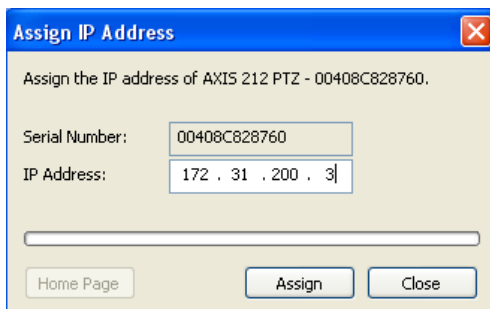

You will need to restart (power OFF and ON) the camera after the address is changed. (Just unplug and plug back the Ethernet cable if you are using the POE).

It can take a while before the confirmation box appears.

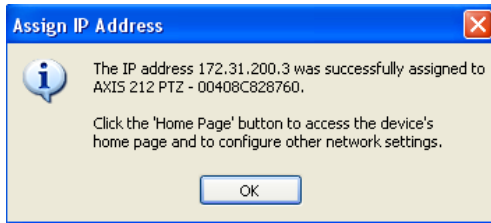

Click the “Close” button.

The first IP camera has been correctly assigned

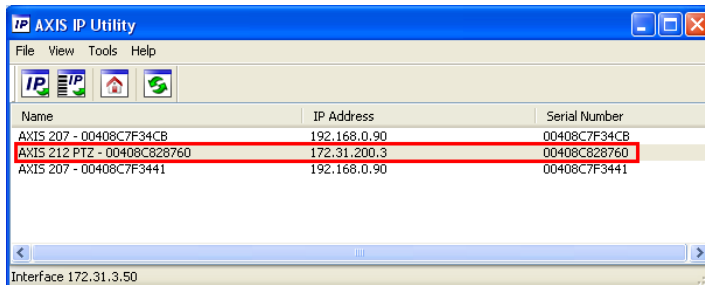

Repeat the process with the other cameras

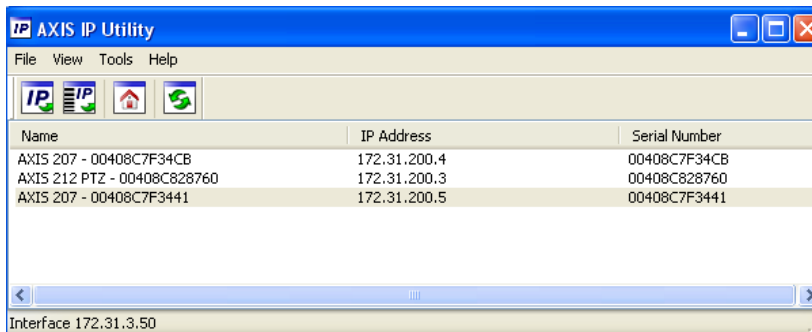

6.3.4. Configure the camera

The cameras need to be configured using an Internet Explorer.

Enter the IP address of the first IP camera:

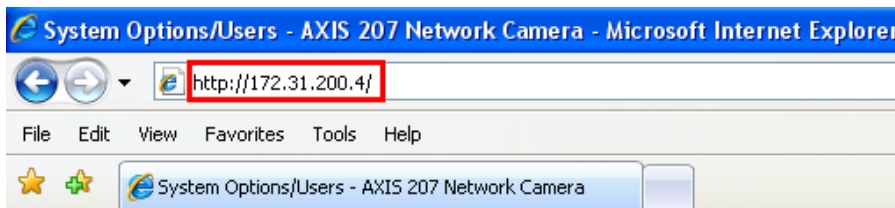

Set the password of the IP camera to “pass” and click “OK”

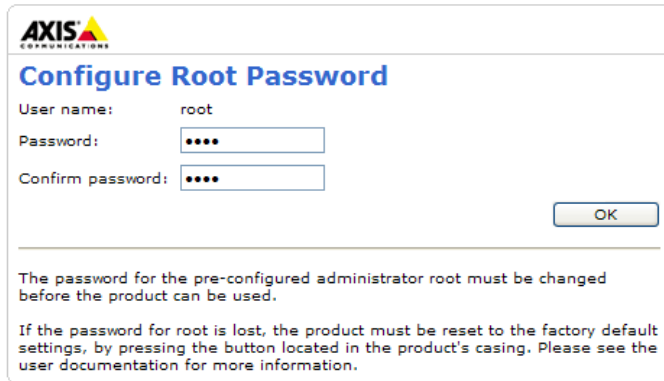

Important: You cannot use another password and must use the word “pass”.

When you press OK, a dialog box asking for a login/password will appear. Just use “root” and “pass”.



When the webpage loads, pay attention to the top of the page to authorize the installation of the ActiveX. Click on the yellow bar and choose “Install ActiveX”

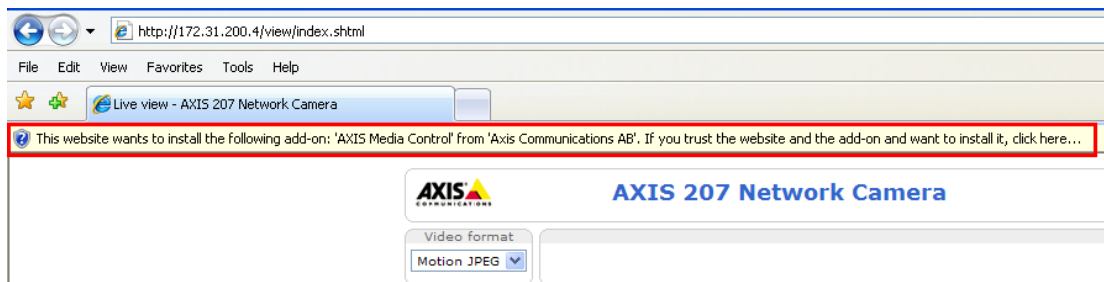

At this point a camera image should appear

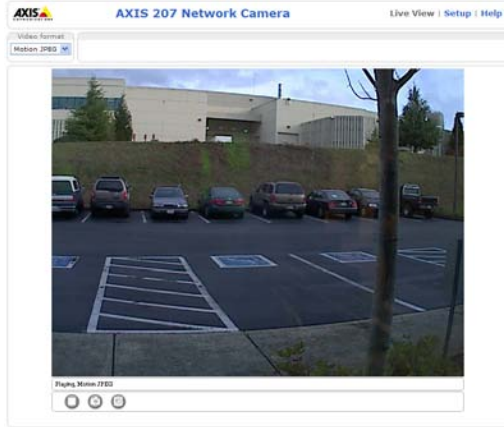

Now, click on Setup

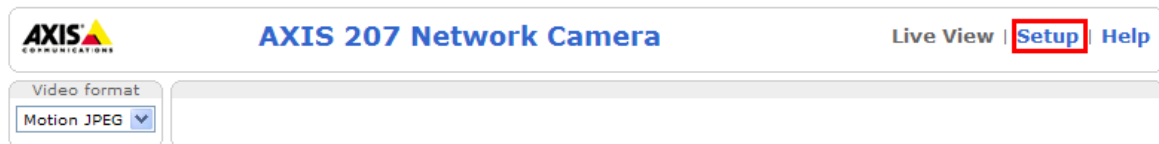

- 1) In “Basic Configuration -> Users” select “Enable anonymous viewer...” and click on “Save”

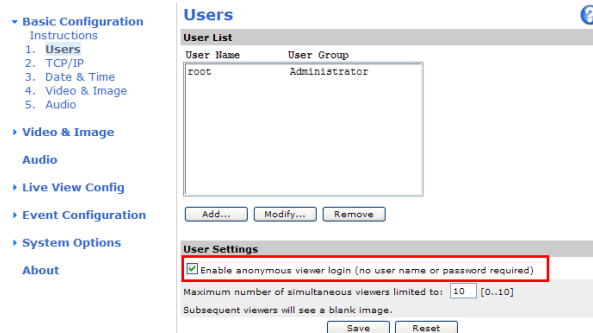

- 2) In “Basic Configuration -> Date and Time” select “Synchronize with computer time” and click on “Save”
- 3) In “Live View Config -> Layout” select “MPEG4” as the default video format and click on save



- 4) Optional: When using a PTZ (moving) camera, you can set-up the default “Home” position. In “PTZ configuration -> Preset Positions”, adjust the view of the default camera position using the control

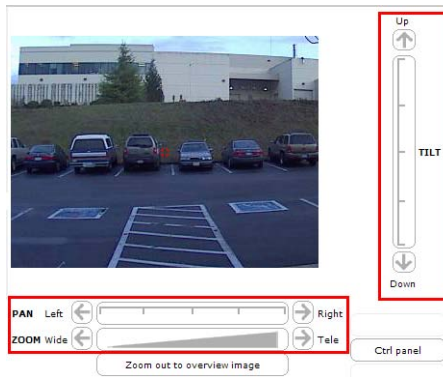

Note: It is recommended to zoom in on the image (Tele) to have a better “Home” preset.

When the view is correctly set up, type “Home” for the Current position and select “Use current position as Home”. Click on “Add” to validate.

Preset Position Setup

Current position:

Use current position as Home

If you don't want the camera to return to the “Home” position automatically after 30 sec, just put 0 and validate.

Return to overview after:
 [0..300] seconds,
 0 = disabled

- 5) Some IP Camera models (such as the 215 or 233) need to have the “Aspect Ratio” setting checked and the resolution set to “4CIF” or “640*480” to be compatible with the MFD8/12. This setting can be found under the “Video & Image” section.

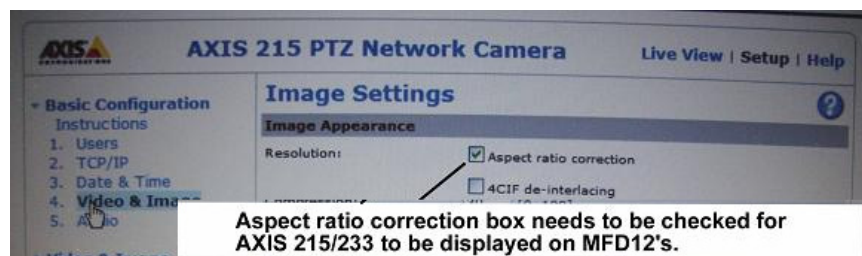

- 6) Under the “Video & Image” menu -> “Advanced” -> “MPEG-4”

- Check “ISMA Compliant” (when available)
Note: on some camera models, this settings is not available (simply proceed to the next step)
- Limit the Maximum Bit Rate to 500kbit/s for engine monitoring (fixed picture) and to 800kbit/s for outdoor camera (where the picture changes)

AXIS 225FD Network Camera Live View | Setup | Help

MPEG-4 Settings

Client Compatibility
Video object type:

ISMA compliant

GOV Settings
Structure:
Length: [2-150]

Bit Rate Control
Maximum bit rate: Unlimited
 Limited to kbit/s
 Variable bit rate
 Constant bit rate
Use:
Target bit rate: kbit/s
Priority:

Video Stream
Optimize the video stream for:

View Image Settings
View image after saving.

7) Under the “Video & Image” menu -> “Image”

- Set the Maximum Frame Rate to 15fps

AXIS 225FD Network Camera Live View | Setup | Help

Image Settings

Image Appearance
Resolution: pixels
Compression: [0..100]
Rotate image: degrees
White balance:

Text Overlay Settings
 Include date Include time
 Include text:
Text color: Text background color:
Place text/date/time at of image







Video Stream
Maximum video stream time:
 Unlimited
 Limited to [1..] seconds per session
Maximum frame rate:
 Unlimited
 Limited to [1..30] fps per viewer

Test
Test settings (using Motion JPEG) before saving.

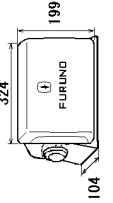
PACKING LIST MFD8-J/E

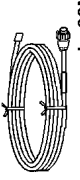
198A-X-9851-4

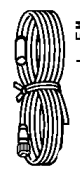

1/1

NAME	OUTLINE	DESCRIPTION/CODE No.	Q'TY
ユニット			
マルチファンクションディスプレイ		MFD8-J/E 000-011-776-00 **	1
予備品			
予備品		SP19-00701 001-028-020-00	1
付属品			
付属品		FP19-01101 001-023-060-00	1
工事材料			
ケーブル組品LAN		MOD-WPAS0001-030+ 000-164-609-10	1
ケーブル組品		FRUDD-18AFFM-L180 000-164-608-10	1
ケーブル組品MJ		MJ-A3SPF0017-050ZC 000-157-995-10	1
工事材料		CP19-00901 001-028-050-00	1

1.コード番号末尾の[**]は、選択品の代表コードを表します。
CODE NUMBER ENDING WITH "**" INDICATES THE CODE NUMBER OF REPRESENTATIVE MATERIAL.

2.(*)は、それぞれ仕様選択品を表します。
(*1)INDICATE SPECIFICATION SELECTIVE ITEM.

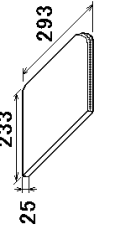
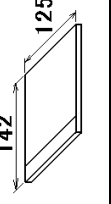
(略図の寸法は、参考値です。DIMENSIONS IN DRAWING FOR REFERENCE ONLY.)

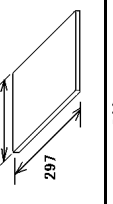
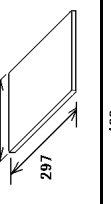
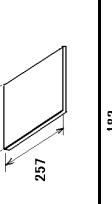
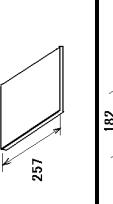
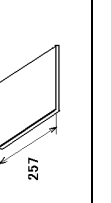
NAME	OUTLINE	DESCRIPTION/CODE No.	Q'TY
図書			
書類ケース		H293XW230XT18 000-168-580-10	1
取扱説明CD		NAVNET3 O/M *CD-ROM*	1
オペレータのマニュアルCD		000-167-721-1*	
フラッシュメモリ型紙		C42-00709-* 7/1	1
フラッシュマウント用テンプレート		000-167-941-1*	
ヒューズ変更のお願い 7/1		C42-00706-*	1
NOTIFICATION DOCUMENT		000-167-809-1*	
装備要領書		IM*-44440-*	1
INSTALLATION MANUAL		000-167-806-1*	**
操作要領書(タケン)		MLG-44440-*	1
オペレータのガイド		000-167-805-1*	(*1)
操作要領書(和)		OSJ-44440-*	1
オペレータのガイド		000-167-803-1*	(*1)
取扱説明書		OM*-44441-*	1
オペレータのマニュアル		000-167-814-1*	**







3.付属品及び一部の図書は、書類ケースに収められています。
ACCESSORIES AND A PART OF THE DOCUMENTS IS PUT IN THE DOCUMENTS CASE.

型式/コード番号が2段の場合、下段より上段に代わる運送期品であり、どちらかが入っています。なお、品質は変わりません。
TWO TYPES AND CODES MAY BE LISTED FOR AN ITEM. THE LOWER PRODUCT MAY BE SHIPPED IN PLACE OF THE UPPER PRODUCT. QUALITY IS THE SAME.

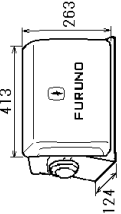
PACKING LIST MFD12-J/E

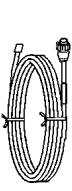
198A-X-9852 -5

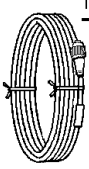
1/1





NAME	OUTLINE	DESCRIPTION/CODE No.	Q'TY
ユニット UNIT			
マルチファンクションディスプレイ		MFD12-J/E 000-011-778-00 **	1
予備品 SPARE PARTS			
予備品		SP19-00801 001-028-030-00	1
付属品 ACCESSORIES			
付属品		FP19-01101 001-023-060-00	1
工事材料 INSTALLATION MATERIALS CP19-01000			
ケーブル組品LAN		MOD-WPAS0001-030+ 000-164-609-10	1
ケーブル組品		FRUDD-18AFFM-L180 000-164-608-10	1
ケーブル組品MJ		MJ-A3SPF0027-050ZC 000-153-769-11	1
工事材料		CP19-01001 001-028-060-00	1

1.コード番号末尾の[**]は、選択品の代表コードを表します。
CODE NUMBER ENDING WITH "**" INDICATES THE CODE NUMBER OF REPRESENTATIVE MATERIAL.

2.(*)は、仕様選択品を表します。

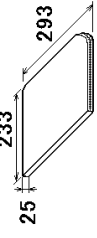
(*)INDICATE SPECIFICATION SELECTIVE ITEM.

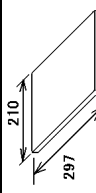
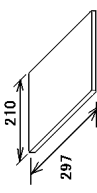
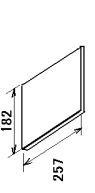
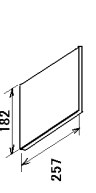
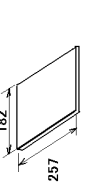
(略図の寸法は、参考値です。DIMENSIONS IN DRAWING FOR REFERENCE ONLY.)

図書	NAME	DOCUMENT	OUTLINE	DESCRIPTION/CODE No.	Q'TY
書類ケース	DOCUMENTS CASE			H293XW230XT18 000-168-580-10	1
取扱説明CD	OPERATOR'S MANUAL CD			NAVNET3 O/M *CD-ROM*	1
ヒューズ変更のお願い 7/11	NOTIFICATION DOCUMENT			000-167-721-1*	1
装備要領書	INSTALLATION MANUAL			000-167-809-1*	1
操作要領書(タゲン)	OPERATOR'S GUIDE			IM*-44440-* 000-167-806-1*	1
操作要領書(和)	OPERATOR'S GUIDE			MLG-44440-* 000-167-805-1*	(*)
取扱説明書	OPERATOR'S MANUAL			OSJ-44440-* 000-167-803-1*	1
フラッシュマウント型紙	FLUSH MOUNTING TEMPLATE			OM*-44441-* 000-167-814-1* ** C42-00704-* 7/11 000-167-224-1*	1

3.付属品及び一部の図書は、書類ケースに収められています。

ACCESSORIES AND A PART OF THE DOCUMENTS IS PUT IN THE DOCUMENTS CASE.

型式/コード番号が2段の場合、下段より上段に代わる過渡期品であり、どちらかが入っています。なお、品質は変わりません。

TWO TYPES AND CODES MAY BE LISTED FOR AN ITEM. THE LOWER PRODUCT MAY BE SHIPPED IN PLACE OF THE UPPER PRODUCT. QUALITY IS THE SAME.

FURUNO

MULTI FUNCTION DISPLAY
MFD8

CODE NO.		198A-X-9401-2		1/1	
TYPE		CP19-00901			
番号 NO.	名称 NAME	略図 OUTLINE	型名/規格 DESCRIPTIONS	数量 Q'TY	用途/備考 REMARKS
1	ヒータ/ワザ FUSE LABEL		19-028-2231-0 CODE NO. 100-346-980-10	1	
2	マウント用スポンジ MOUNTING SPONGE		19-028-3122-1 CODE NO. 100-343-141-10	1	
3	ケーブル保持金具 CABLE FIXING PLATE		19-028-3123-2 CODE NO. 100-342-592-10	1	
4	+ワザ用ヒータ SELF-TAPPING SCREW		5X20 SUS304 CODE NO. 100-162-608-10	4	
5	ケーブル CABLE TIE		CV-150B CODE NO. 100-167-183-10	1	
6	+ワザ用ヒータ BINDING HEAD SCREW		M3X10 SUS304 CODE NO. 100-162-662-10	2	

型式/コード番号が2段の場合、下段より上段に代わる部品であり、どちらが入っています。なお、品質は変わりません。
TWO TYPES AND CODES MAY BE LISTED FOR AN ITEM. THE LOWER PRODUCT MAY BE SHIPPED IN PLACE OF THE UPPER PRODUCT.
QUALITY IS THE SAME.
(略図の寸法は、参考値です。 DIMENSIONS IN DRAWING FOR REFERENCE ONLY.)

FURUNO

MULTI FUNCTION DISPLAY
MFD12

CODE NO.		198A-X-9402-2		1/1	
TYPE		CP19-01001			
番号 NO.	名称 NAME	略図 OUTLINE	型名/規格 DESCRIPTIONS	数量 Q'TY	用途/備考 REMARKS
1	マウント用スポンジ MOUNTING SPONGE		19-028-2062-0 CODE NO. 100-340-040-10	1	
2	ヒータ/ワザ FUSE LABEL		19-028-2231-0 CODE NO. 100-346-980-10	1	
3	ケーブル保持金具 CABLE FIXING PLATE		19-028-3123-2 CODE NO. 100-342-592-10	1	
4	+ワザ用ヒータ SELF-TAPPING SCREW		5X20 SUS304 CODE NO. 100-162-608-10	4	
5	ケーブル CABLE TIE		CV-150B CODE NO. 100-167-183-10	1	
6	+ワザ用ヒータ BINDING HEAD SCREW		M3X10 SUS304 CODE NO. 100-162-662-10	2	

型式/コード番号が2段の場合、下段より上段に代わる部品であり、どちらが入っています。なお、品質は変わりません。
TWO TYPES AND CODES MAY BE LISTED FOR AN ITEM. THE LOWER PRODUCT MAY BE SHIPPED IN PLACE OF THE UPPER PRODUCT.
QUALITY IS THE SAME.
(略図の寸法は、参考値です。 DIMENSIONS IN DRAWING FOR REFERENCE ONLY.)



表 1 TABLE 1

寸法区分 (mm) DIMENSION	公差 (mm) TOLERANCE
L ≤ 50	±1.5
50 < L ≤ 100	±2.5
100 < L ≤ 500	±3

注 記

- 1) # 印寸法は最小サービス空間寸法とする。
 - 2) 指定外の寸法公差は表1による。
 - 3) 取付用ネジはトラスタッピングピンネジ呼び径5×20を使用のこと。
- NOTE
1. # MINIMUM SERVICE CLEARANCE.
 2. TABLE 1 INDICATES TOLERANCE OF DIMENSIONS WHICH IS NOT SPECIFIED.
 3. USE TAPPING SCREWS φ5x20 FOR FIXING THE UNIT.

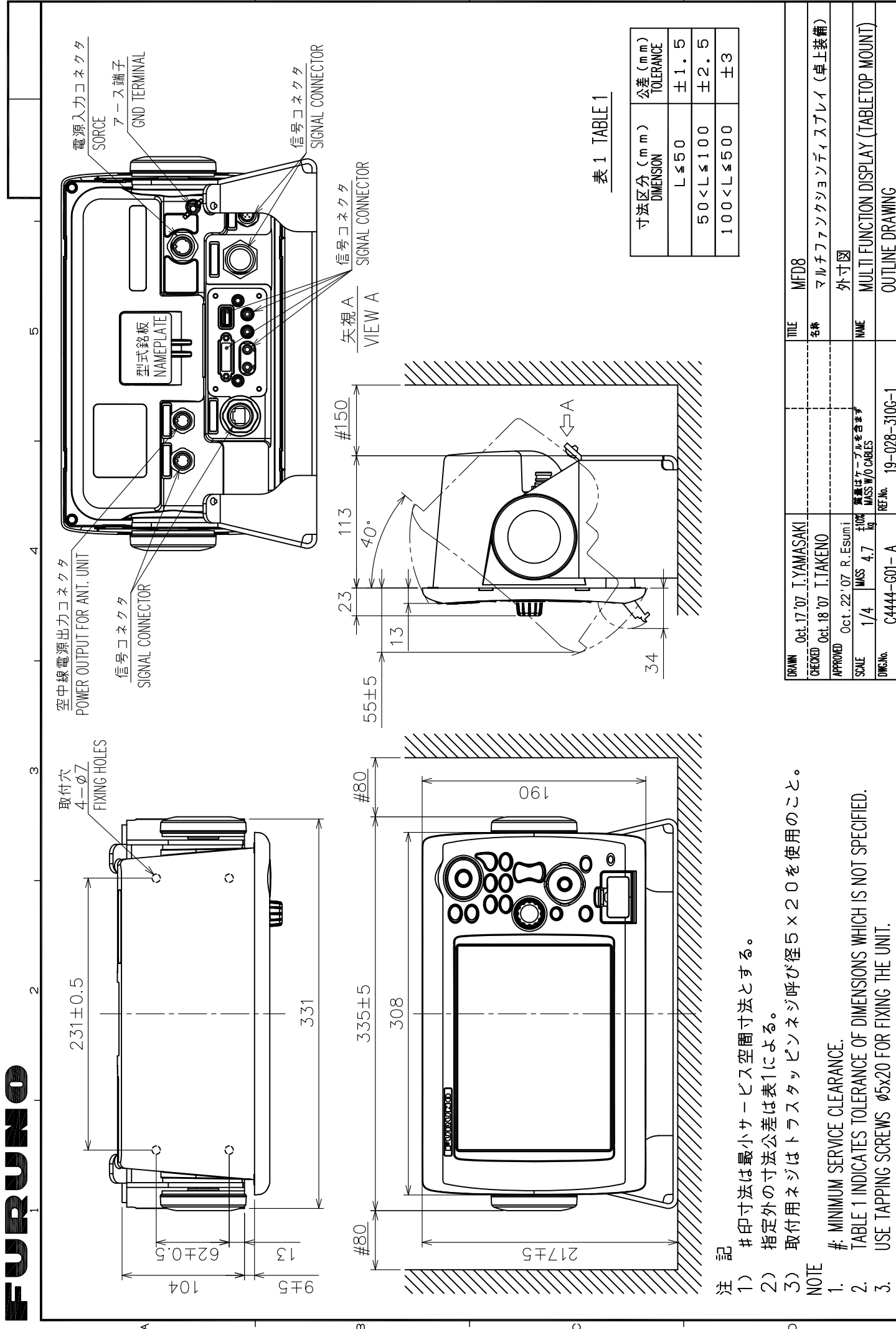
DRAWN	Oct. 17 '07	I. YAMASAKI	TITLE	MFD8
CHECKED	Oct. 18 '07	I. TAKENO	名称	マルチファンクションディスプレイ (卓上装備)
APPROVED	Oct. 22 '07	R. Esumi	外寸図	
SCALE	1/4	質量はケーブルを含む MASS W/O CABLES	NAME	MULTI FUNCTION DISPLAY (TABLETOP MOUNT)
DWG.No.	C4444-G01-A	REF.No.	19-028-310G-1	OUTLINE DRAWING

表 1 TABLE 1

寸法区分 (mm) DIMENSION	公差 (mm) TOLERANCE
L ≤ 50	± 1.5
50 < L ≤ 100	± 2.5
100 < L ≤ 500	± 3

4-取付穴位置
PILOT HOLES

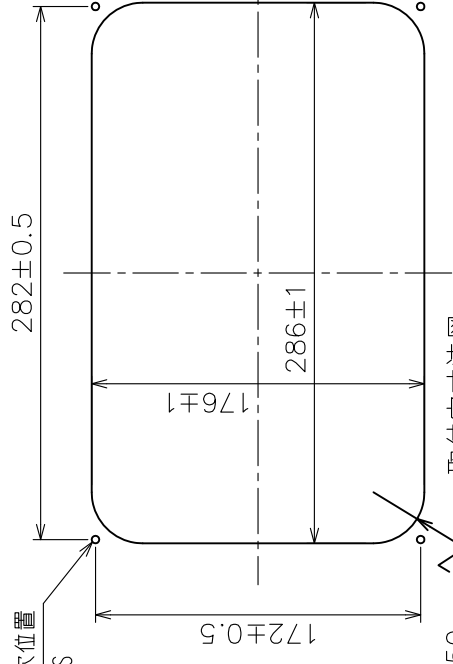

取付穴寸法図
CUTOUT DIMENSIONS

空中線電源出力コネクタ
POWER OUTPUT FOR ANT. UNIT

電源入力コネクタ SOURCE
アース端子 GND TERMINAL
信号コネクタ SIGNAL CONNECTOR
信号コネクタ SIGNAL CONNECTOR

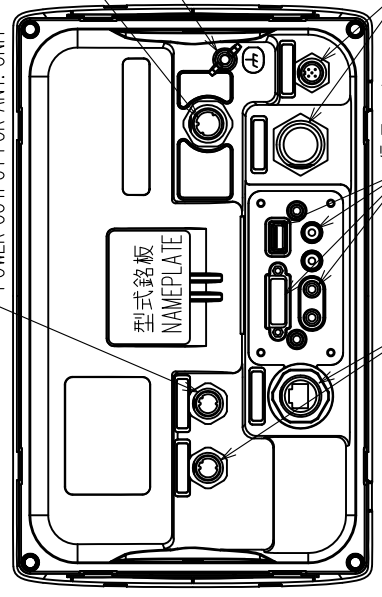

4-取付穴位置
PILOT HOLES

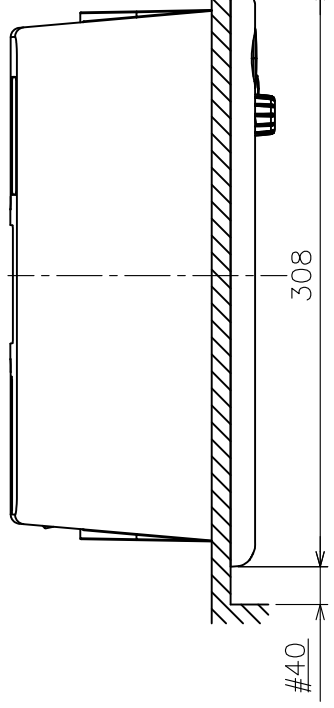

取付穴
4-φ6
FIXING HOLES

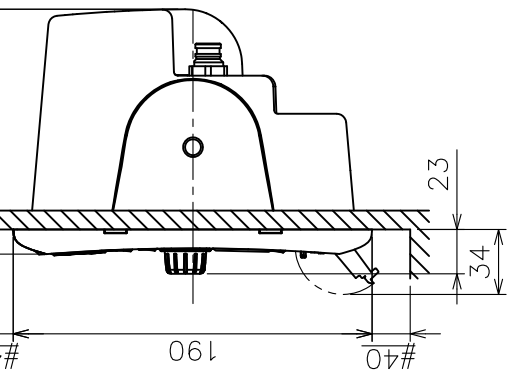

注 記

- 1) #印寸法は最小サービス空間寸法とする。
- 2) 指定外の寸法公差は表1による。
- 3) 取付用ネジはトラスター呼び径5×20を使用のこと。

NOTE

1. # MINIMUM SERVICE CLEARANCE.
2. TABLE 1 INDICATES TOLERANCE OF DIMENSIONS WHICH IS NOT SPECIFIED.
3. USE TAPPING SCREWS φ5x20 FOR FIXING THE UNIT.

DRAWN	Oct. 17 '07	I. YAMASAKI	TITLE	MFD8
CHECKED	Oct. 18 '07	I. TAKENO	名称	マルチファンクションディスプレイ (埋込装備)
APPROVED	Oct. 22 '07	R. Esumi	外寸図	
SCALE	1/4	質量はケーブルを含む ±10% MASS W/O CABLES	NAME	MULTI FUNCTION DISPLAY (FLUSH MOUNT)
DWG.No.	C4444-G02-A	REF.No.	19-028-300G-1	OUTLINE DRAWING

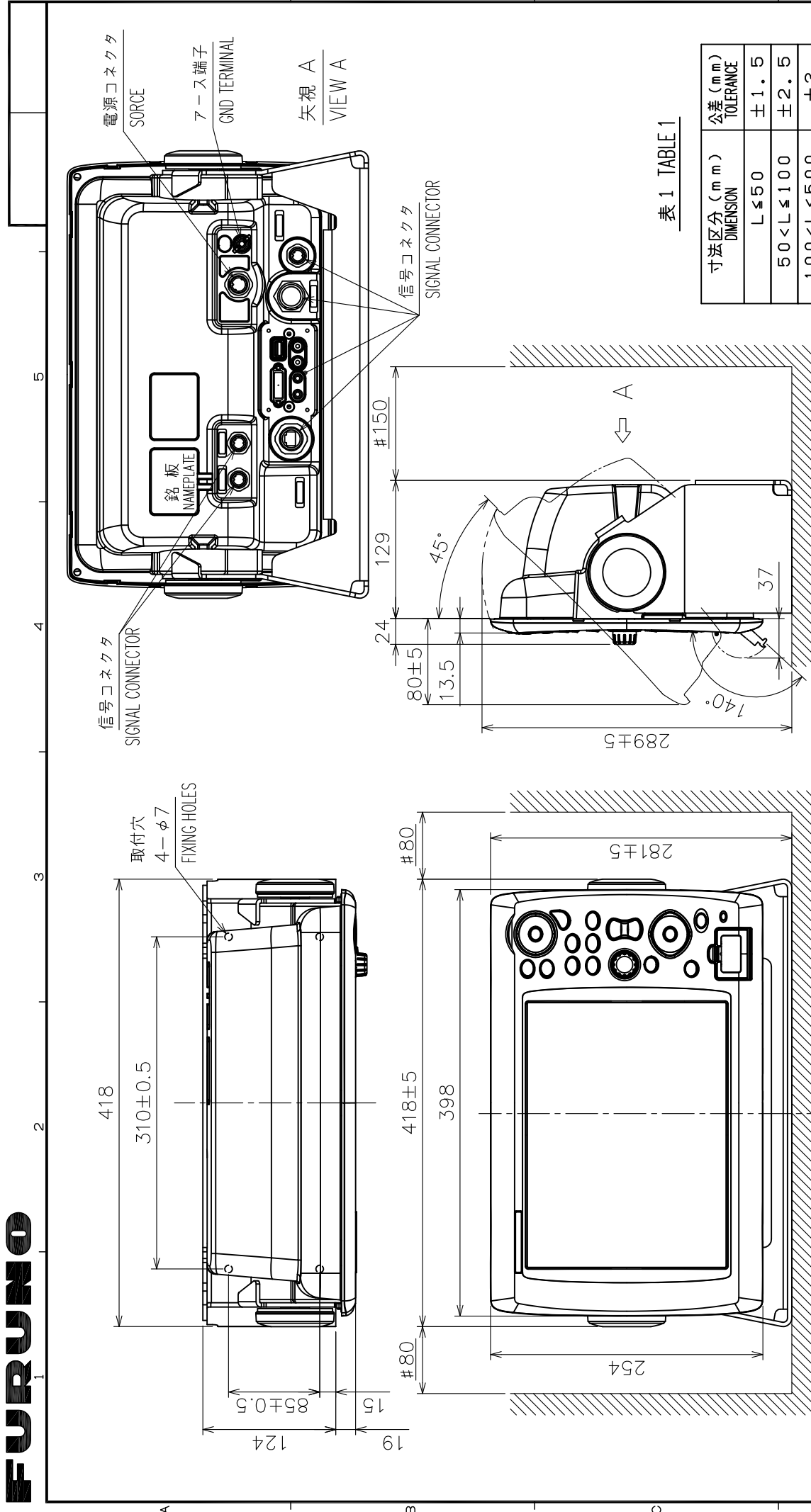

注記

- 1) #印寸法は最小サービスクリアランスとする。
- 2) 指定外の寸法公差は表1による。
- 3) 取付用ネジは+トラスタップピンネジ呼び径5×20を使用のこと。

NOTE

1. # MINIMUM SERVICE CLEARANCE.
2. TABLE 1 INDICATES TOLERANCE OF DIMENSIONS WHICH IS NOT SPECIFIED.
3. USE TAPPING SCREWS φ5x20 FOR FIXING THE UNIT.

DRAWN	Oct.17'07	I.YAMASAKI	TITLE	MFD12
CHECKED	Oct.18'07	I.TAKENO	名称	マルチファンクションディスプレイ (卓上装備)
APPROVED	Oct.23'07	R. Esumi	外寸図	
SCALE	1/5	質量はケーブルを含み MASS W/O CABLES	NAME	MULTI FUNCTION DISPLAY (TABLETOP MOUNT)
DWG.No.	C4445-G01-A	REF.No.	19-028-225G-2	OUTLINE DRAWING

表 1 TABLE 1

寸法区分 (mm) DIMENSION	公差 (mm) TOLERANCE
L ≤ 50	±1.5
50 < L ≤ 100	±2.5
100 < L ≤ 500	±3

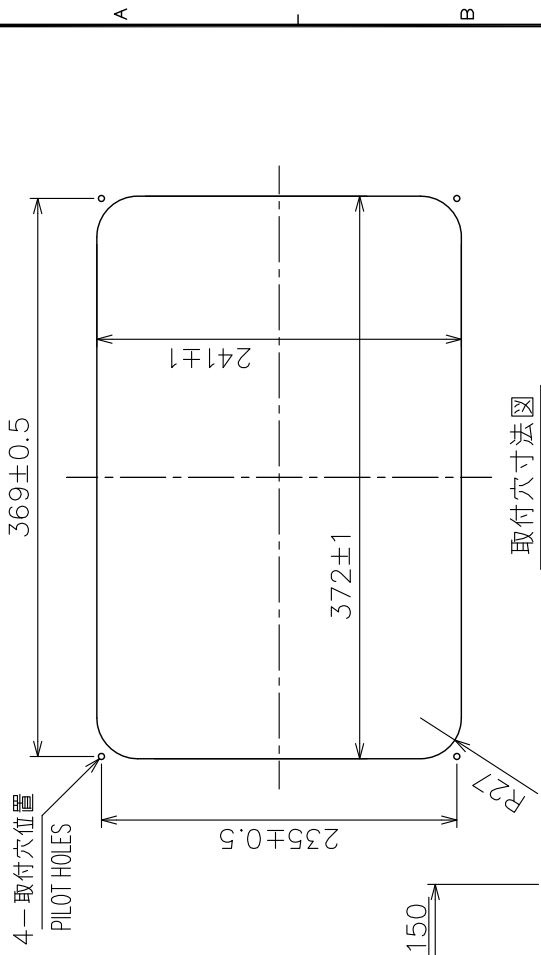

取付穴寸法図
CUTOUT DIMENSIONS

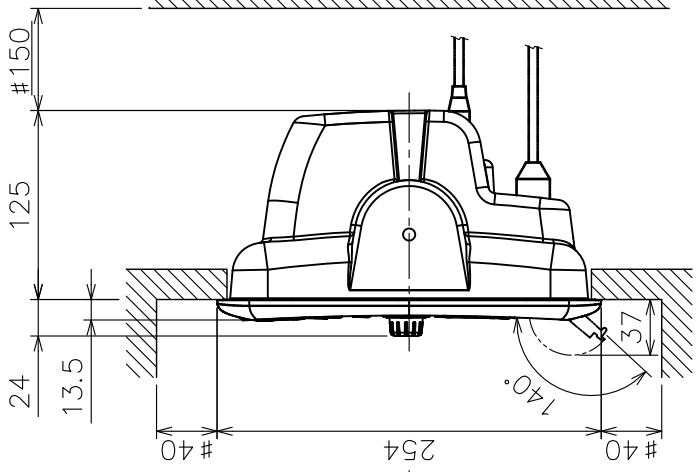
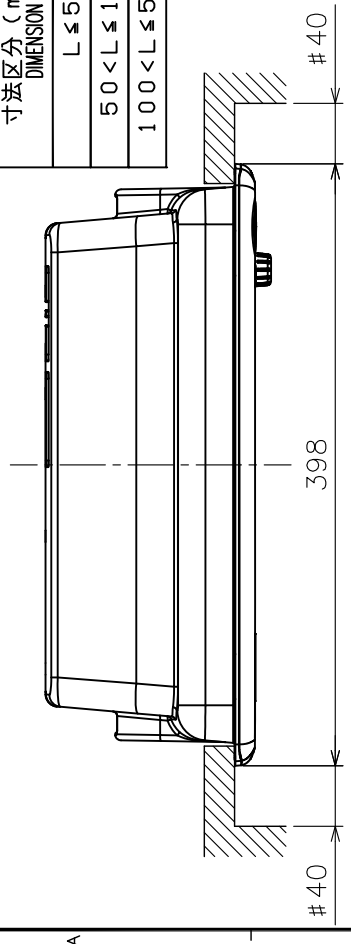

取付穴
4-φ6
FIXING HOLES

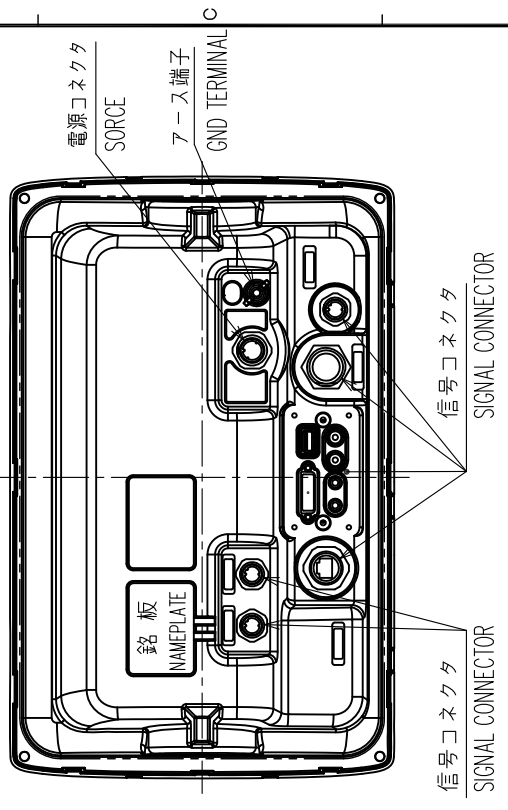

- 注 記
- 1) #印寸法は最小サージスペース寸法とする。
 - 2) 指定外の寸法公差は表1による。
 - 3) 取付用ネジは+トラスター呼び径5×20を使用のこと。
- NOTE
1. # MINIMUM SERVICE CLEARANCE.
 2. TABLE 1 INDICATES TOLERANCE OF DIMENSIONS WHICH IS NOT SPECIFIED.
 3. USE TAPPING SCREWS φ5x20 FOR FIXING THE UNIT.

DRAWN	Oct. 17 '07	I. YAMASAKI	TITLE	MFD12
CHECKED	Oct. 18 '07	I. TAKENO	名称	マルチファンクションディスプレイ (埋込装備)
APPROVED	Oct. 23 '07	R. ESUMI	外寸図	
SCALE	1/5	質量はケーブルを含み MASS W/O CABLES	NAME	MULTI FUNCTION DISPLAY (FLUSH MOUNT)
DWG. No.	C4445-G02-A	REF. No.	19-028-220G-1	OUTLINE DRAWING

A

B

C

D

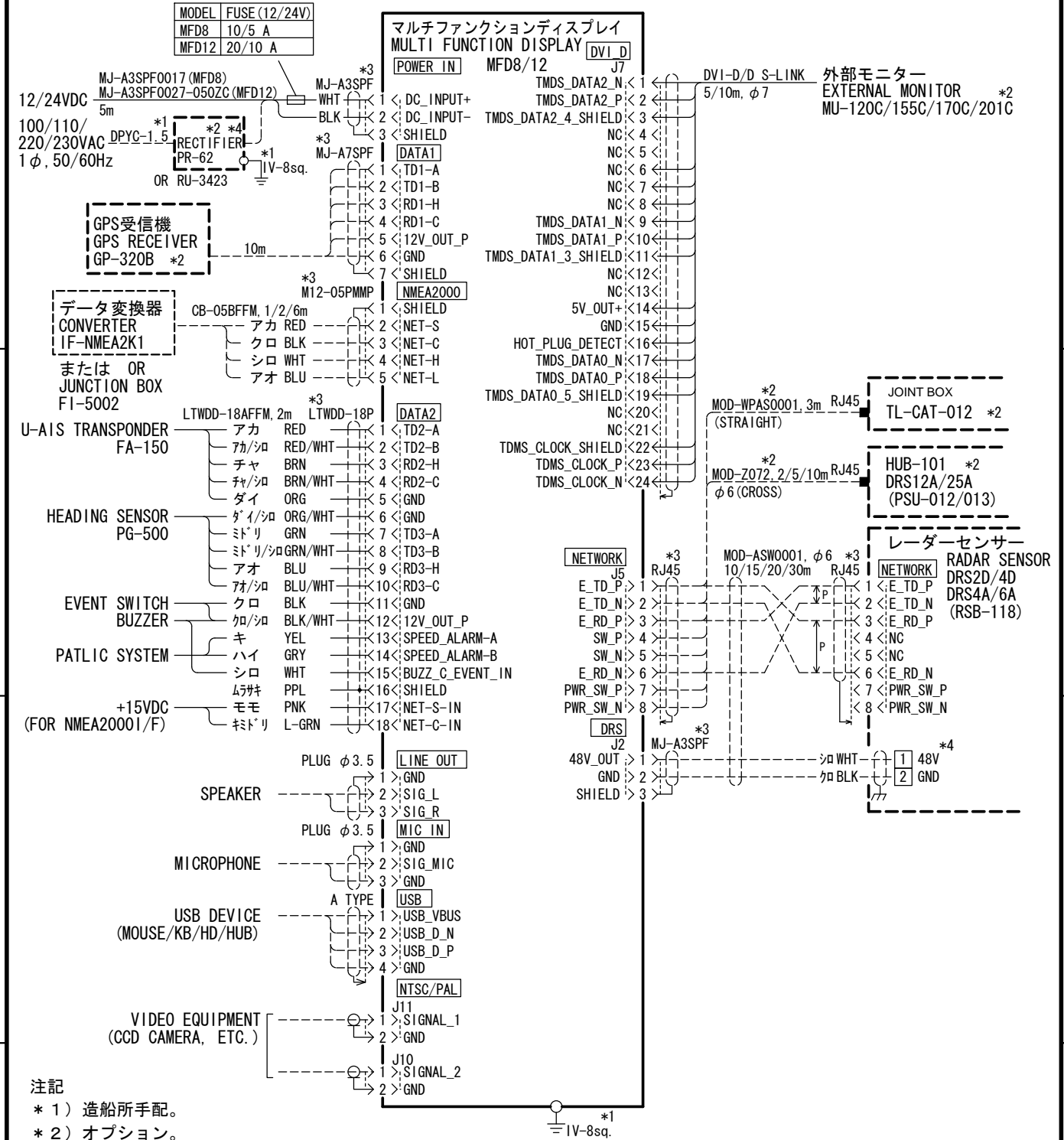

注記

- * 1) 造船所手配。
- * 2) オプション。
- * 3) コネクタは工場にて取付済み。
- * 4) レーダーセンサーに接続するとき、整流器はRU-3423を使用する。





NOTE

- *1: SHIPYARD SUPPLY.
- *2: OPTION.
- *3: CONNECTOR PLUG FITTED AT FACTORY.
- *4: USE RECTIFIER RU-3423 TO CONNECT A RADAR SENSOR.

DRAWN Jan. 24 '08 T. YAMASAKI		TITLE MFD8/12	
CHECKED Jan. 24 '08 T. TAKENO		名称 マルチファンクションディスプレイ	
APPROVED Feb. 20 '08 R. Esumi		相互結線図	
SCALE	MASS kg	NAME MULTI-FUNCTION DISPLAY	
DWG No. C4444-C01-B	REF. No. 19-028-5002-2	INTERCONNECTION DIAGRAM	

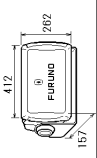
PACKING LIST

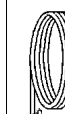
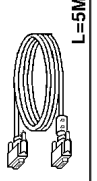
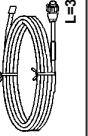
DCU12

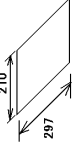



N A M E	O U T L I N E	D E S C R I P T I O N / C O D E N o.	Q T Y
ユニット			
制御部 PROCESSOR UNIT		DCU12 000-011-671-00	1
予備品			
予備品		SP19-00601 001-023-040-00	1
付属品			
付属品		FP19-01101 001-023-060-00	1
アクセサリ			
アクセサリ		001-023-060-00	1
工事材料			
ケーブル組品		DVI-D/D SINGLE LINK 5M 000-149-054-00	1
CABLE ASSY.		LAN CABLE ASSEMBLY MOD-HPASS0001-030+ 000-164-609-10	1
ケーブル組品		MJ-ASSPF0013-035C (5A) 000-157-939-10	1
CABLE ASSY.		CP19-00801 001-023-050-00	1
図書			
フックアップ型紙		C42-00704-* 7/E1 000-167-224-1*	1

型式/コード番号が2段の場合、下段より上段に代わる過渡期品であり、どちらかが入っています。なお、品質は変わりません。
TWO TYPES AND CODES MAY BE LISTED FOR AN ITEM. THE LOWER PRODUCT MAY BE SHIPPED IN PLACE OF THE UPPER PRODUCT. QUALITY IS THE SAME.
(略図の寸法は、参考値です。 DIMENSIONS IN DRAWING FOR REFERENCE ONLY.)

19AY-X-9852

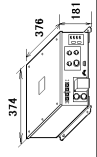
PACKING LIST

MPU-001-E/J

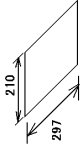
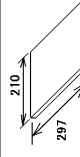
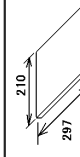
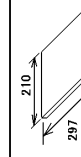
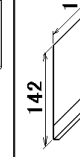
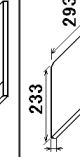
N A M E	O U T L I N E	D E S C R I P T I O N / C O D E N o.	Q T Y
ユニット			
制御部 PROCESSOR UNIT		MPU-001-E/J 000-011-919-00	1
予備品			
予備品		SP19-00501 001-023-090-00	1
工事材料			
ケーブル組品		FRUDD-18AFFM-L180 000-164-608-10	1
CABLE ASSEMBLY		CP19-00601 001-023-100-00	1
図書			
ローズ変更のお願い(和/英)		C42-00705-* 000-167-240-1*	1
取扱説明書		OM*-44461-* 000-167-235-1*	1
OPERATOR'S MANUAL		OSJ/MLG-44460-* 000-167-222-1*	1
操作要領書		ILM*-44460-* 000-167-222-1*	1
INSTALLATION MANUAL		NAVNET3 0/M *CD-ROM* 000-167-721-1*	1
取扱説明CD		H293XW230XT18 000-168-580-10	1
書類ケース	DOCUMENTS CASE		

1.コード番号末尾の[*]は、選択品の代表コードを表します。
CODE NUMBER ENDING WITH "*" INDICATES THE CODE NUMBER OF REPRESENTATIVE MATERIAL.
2.一部の図書は、書類ケースに収められています。
A PART OF THE DOCUMENTS IS PUT IN THE DOCUMENTS CASE.

型式/コード番号が2段の場合、下段より上段に代わる過渡期品であり、どちらかが入っています。なお、品質は変わりません。
TWO TYPES AND CODES MAY BE LISTED FOR AN ITEM. THE LOWER PRODUCT MAY BE SHIPPED IN PLACE OF THE UPPER PRODUCT. QUALITY IS THE SAME.
(略図の寸法は、参考値です。 DIMENSIONS IN DRAWING FOR REFERENCE ONLY.)

19AY-X-9853

FURUNO



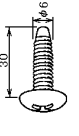
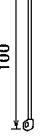

工事材料表

MPU-001		CODE NO.	19AY-X-9401 -1	1/1	
		TYPE	CP19-00601		
番号 NO.	名称 NAME	略図 OUTLINE	型名/規格 DESCRIPTIONS	数量 Q'TY	用途/備考 REMARKS
1	自己タッピングネジ 1/2		6X30 SUS304 CODE NO. 000-162-614-10	4	
2	ケーブルタイ CABLE TIE		CV-100N CODE NO. 000-162-167-10	4	

型式/コード番号が2段の場合、下段より上段に代わる過渡部品であり、どちらが入っています。なお、品質は変わりません。
 TWO TYPES AND CODES MAY BE LISTED FOR AN ITEM. THE LOWER PRODUCT MAY BE SHIPPED IN PLACE OF THE UPPER PRODUCT. QUALITY IS THE SAME.
 (略図の寸法は、参考値です。 DIMENSIONS IN DRAWING FOR REFERENCE ONLY.)

PACKING LIST

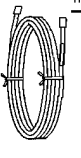
MCU-001

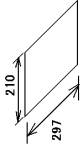
NAME	UNIT	OUTLINE	DESCRIPTION/CODE No.	Q'TY
ユニット				
操作部 CONTROL UNIT			MCU-001 000-011-666-00	1
付属品				
付属品 ACCESSORIES			FPI9-01201 001-033-760-00	1
工事材料				
ケプトル(銅品)LAN				
CABLE ASSY.			MOD-Z072-050+ 000-167-176-10	1
工事材料				
INSTALLATION MATERIALS				
			CP19-00701 001-023-070-00	1
図書				
フラッシュマウント型紙				
FLUSH MOUNTING TEMPLATE JP/EN			C42-00703-* 7/14 000-167-223-1*	1

型式/コード番号が2段の場合、下段より上段に代わる過渡部品であり、どちらが入っています。なお、品質は変わりません。
 TWO TYPES AND CODES MAY BE LISTED FOR AN ITEM. THE LOWER PRODUCT MAY BE SHIPPED IN PLACE OF THE UPPER PRODUCT. QUALITY IS THE SAME.
 (略図の寸法は、参考値です。 DIMENSIONS IN DRAWING FOR REFERENCE ONLY.)

FURUNO

CODE NO.	001-023-050-00	19AY-X-9403 -1	1/1
TYPE	CP19-00801		

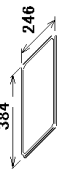
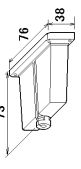
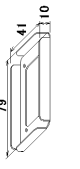
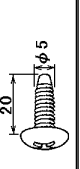
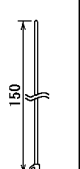
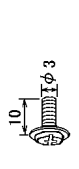
DCU12		INSTALLATION MATERIALS		数量 Q'TY		用途/備考 REMARKS	
番号 NO.	名称 NAME	略図 OUTLINE	型名/規格 DESCRIPTIONS				
1	FマウントスポンジBB MOUNTING SPONGE		19-028-2062-0 CODE NO. 100-340-040-10	1			
2	DVIカバー DVI COVER		19-028-2131-1 CODE NO. 100-340-111-10	1			
3	DVIカバー押込板 COVER FIXING PLATE		19-028-2132-1 CODE NO. 100-340-121-10	1			
4	+5mm径ネジ SELF-TAPPING SCREW		5X20 SUS304 CODE NO. 100-162-608-10	4			
5	凸ネジ CONVEX		CV-150B CODE NO. 100-167-183-10	1			
6	+8mm径小ネジ BINDING HEAD SCREW		MX10 SUS304 CODE NO. 100-162-662-10	4			

型式/コード番号が2段の場合、下段より上段に代わる通線部品であり、どちらかが入っています。なお、品質は変わりません。
TWO TYPES AND CODES MAY BE LISTED FOR AN ITEM. THE LOWER PRODUCT MAY BE SHIPPED IN PLACE OF THE UPPER PRODUCT. QUALITY IS THE SAME.
(略図の寸法は、参考値です。 DIMENSIONS IN DRAWING FOR REFERENCE ONLY.)

FURUNO

CODE NO.	001-023-070-00	19AY-X-9402 -1	1/1
TYPE	CP19-00701		

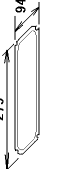
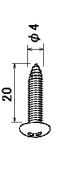
DCU1-001		INSTALLATION MATERIALS		数量 Q'TY		用途/備考 REMARKS	
番号 NO.	名称 NAME	略図 OUTLINE	型名/規格 DESCRIPTIONS				
1	FマウントスポンジBB MOUNTING SPONGE		19-028-1581-2 CODE NO. 100-340-742-10	1			
2	+5mm径ネジ SELF-TAPPING SCREW		4X20 SUS304 CODE NO. 100-168-850-10	4			

型式/コード番号が2段の場合、下段より上段に代わる通線部品であり、どちらかが入っています。なお、品質は変わりません。
TWO TYPES AND CODES MAY BE LISTED FOR AN ITEM. THE LOWER PRODUCT MAY BE SHIPPED IN PLACE OF THE UPPER PRODUCT. QUALITY IS THE SAME.
(略図の寸法は、参考値です。 DIMENSIONS IN DRAWING FOR REFERENCE ONLY.)

FURUNO

付属品表

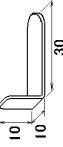
ACCESSORIES		MCU-001		CODE NO.	001-033-760-00	19AY-X-9502-0	1/1
				TYPE	FP19-01201		
番号 NO.	名称 NAME	略図 OUTLINE	型名/規格 DESCRIPTIONS	数量 QTY	用途/備考 REMARKS		
1	パネルリムーバー PANEL REMOVER		19-028-3124-1 CODE NO. 100-340-471-10	1			

型式/コード番号が2段の場合、下段より上段に代わる過渡期品であり、どちらかが入っています。なお、品質は変わりません。
 TWO TYPES AND CODES MAY BE LISTED FOR AN ITEM. THE LOWER PRODUCT MAY BE SHIPPED IN PLACE OF THE UPPER PRODUCT. QUALITY IS THE SAME.
 (略図の寸法は、参考値です。 DIMENSIONS IN DRAWING FOR REFERENCE ONLY.)

FURUNO ELECTRIC CO., LTD.

19AY-X-9502

FURUNO

SHIP NO.		SPARE PARTS LIST FOR		U S E		SETS PER VESSEL	
		DQU12					
ITEM NO.	NAME OF PART	OUTLINE	DWG. NO. OR TYPE NO.	QUANTITY		REMARKS/CODE NO.	
				WORKING PER SET	SPARE		
1	タ- \bar{x} FUSE GLASS TUBE TYPE		FG60A 125V 5A PBF		2	000-155-853-10	
MFR'S NAME		FURUNO ELECTRIC CO., LTD.		DWG NO.	19AY-X-9301	1/1	

(略図の寸法は、参考値です。 DIMENSIONS IN DRAWING FOR REFERENCE ONLY.)
 型式/コード番号が2段の場合、下段より上段に代わる過渡期品であり、どちらかが入っています。なお、品質は変わりません。
 TWO TYPES AND CODES MAY BE LISTED FOR AN ITEM. THE LOWER PRODUCT MAY BE SHIPPED IN PLACE OF THE UPPER PRODUCT. QUALITY IS THE SAME.

表1 TABLE 1

寸法区分 (mm) DIMENSION	公差 (mm) TOLERANCE
L ≤ 50	± 1.5
50 < L ≤ 100	± 2.5
100 < L ≤ 500	± 3

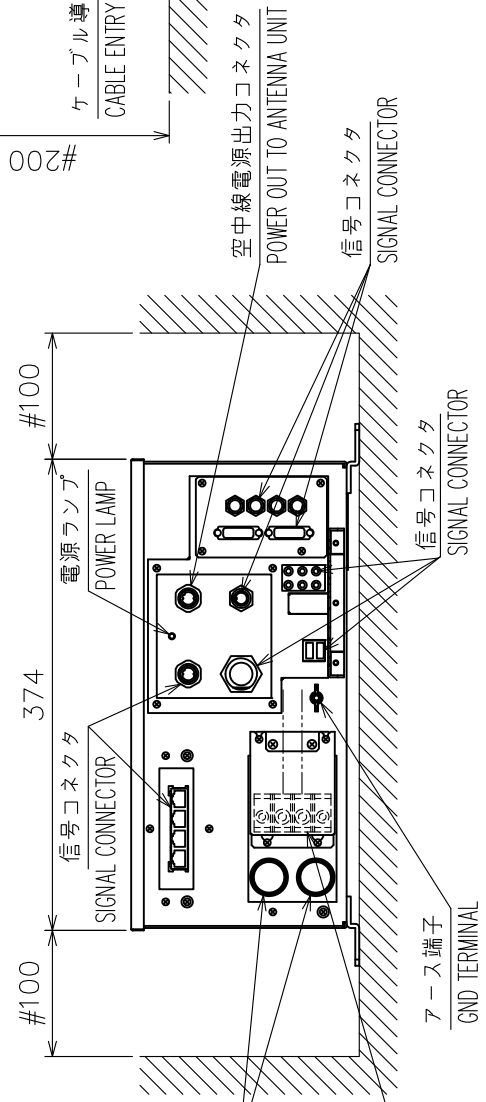
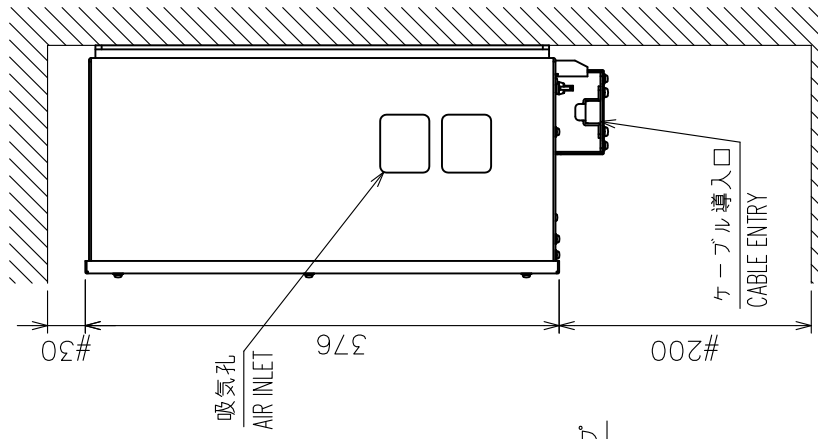
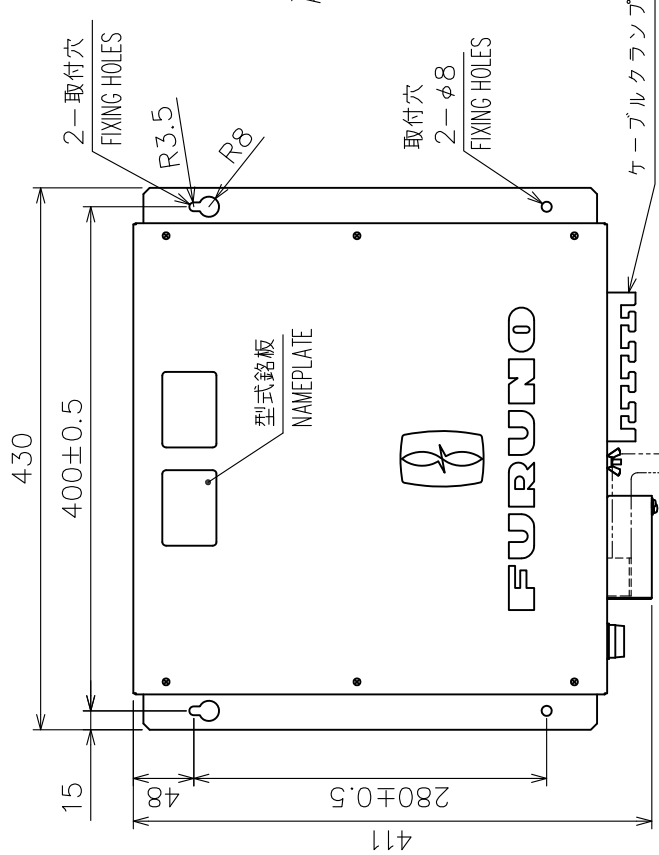
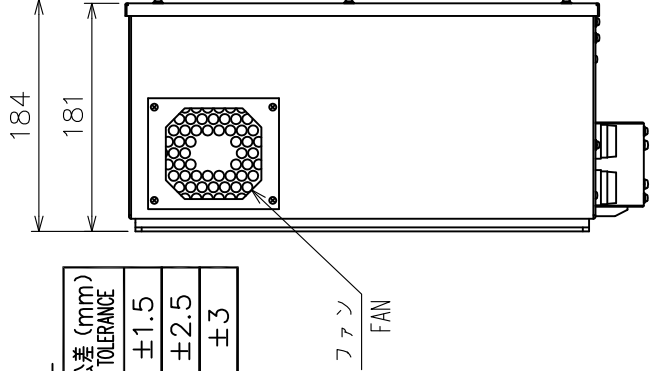

注記

- 1) #印寸法は最小サービス空間寸法とする。
- 2) 指定外の寸法公差は表1による。
- 3) 取付にはトラスタップピンネジ呼び径6×3.0を使用のこと。

NOTE

1. #: MINIMUM SERVICE CLEARANCE.
2. TABLE 1 INDICATES TOLERANCE OF DIMENSIONS WHICH IS NOT SPECIFIED.
3. USE TAPPING SCREWS $\phi 6 \times 3.0$ FOR FIXING THE UNIT.

DRAWN	Jun. 19 '07	I. YAMASAKI	TITLE	MPU-001
CHECKED	Jun. 19 '07	I. TAKENO	名称	制御部
APPROVED	Jun. 27 '07	R. Esumi	外寸図	
SCALE	1/6	WASS 15 kg	NAME	PROCESSOR UNIT
DWG.No.	C4446-G01-A	REF.No.	19-028-100G-2	OUTLINE DRAWING

表1 TABLE 1

寸法区分 (mm) DIMENSION	公差 (mm) TOLERANCE
L ≤ 50	± 1.5
50 < L ≤ 100	± 2.5
100 < L ≤ 500	± 3

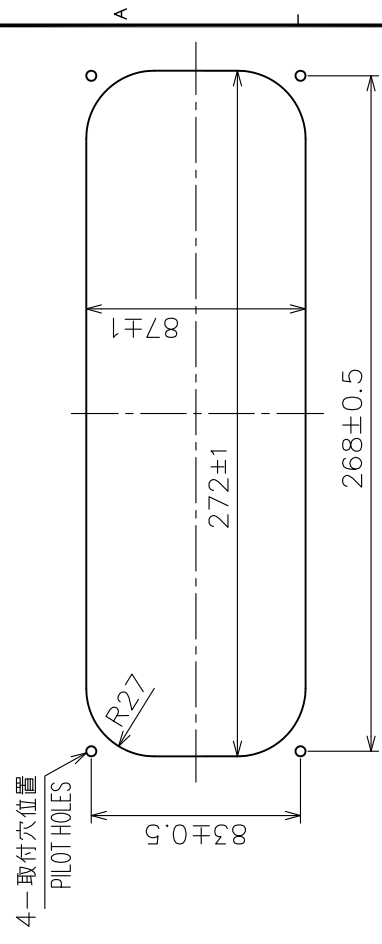

取付穴寸法図
CUTOUT DIMENSIONS

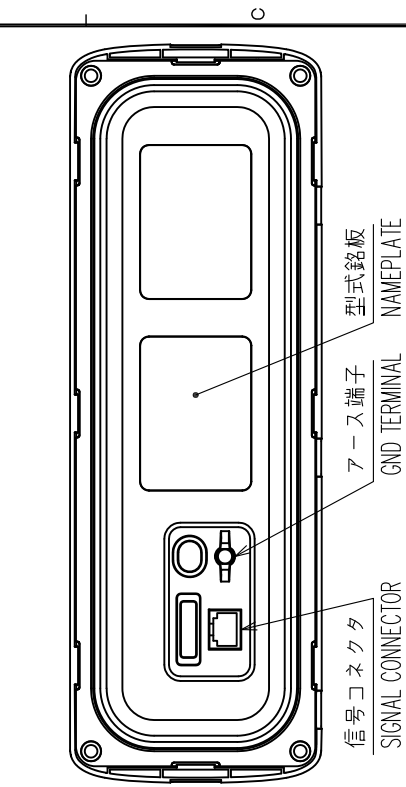
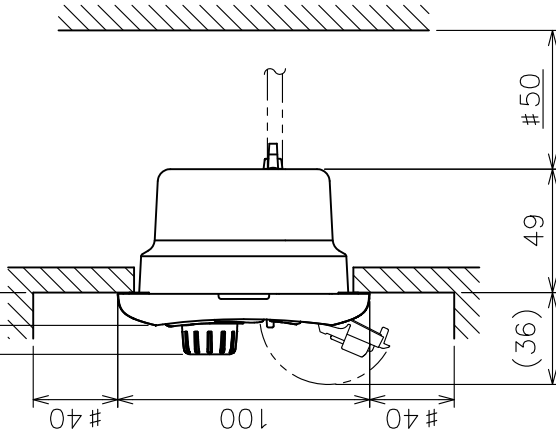
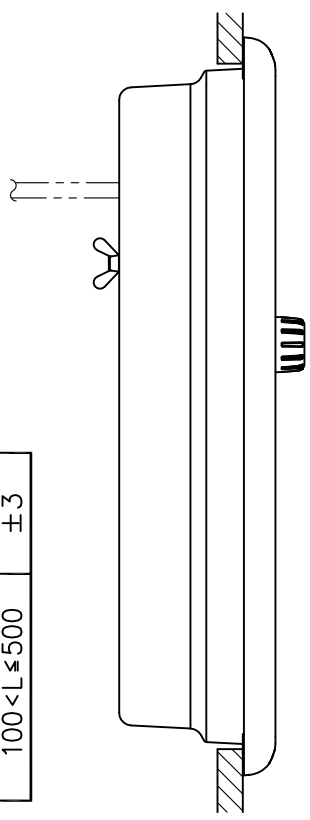

注 記

- 1) #印寸法は最小サービス空間寸法とする。
- 2) 指定外の寸法公差は表1による。
- 3) 取付にはトラスタックピンネジ呼び径4X20を使用のこと。

NOTE

1. #: MINIMUM SERVICE CLEARANCE.
2. TABLE 1 INDICATES TOLERANCE OF DIMENSIONS WHICH IS NOT SPECIFIED.
3. USE TAPPING SCREWS φ4x20 FOR FIXING THE UNIT.

DRAWN	Jun. 19 '07	I. YAMASAKI	TITLE	MCU-001
CHECKED	Jun. 19 '07	I. TAKENO	名称	操作部
APPROVED	Jun. 27 '07	R. Esumi	MFDBB	外寸図
SCALE	1/3	1/3	NAME	CONTROL UNIT
DWG.No.	C4446-G02-A	REF.No.	19-028-150G-1	OUTLINE DRAWING



表 1 TABLE 1

寸法区分 (mm) DIMENSION	公差 (mm) TOLERANCE
L ≤ 50	± 1.5
50 < L ≤ 100	± 2.5
100 < L ≤ 500	± 3

DRAWN	Oct. 17 '07	I. YAMASAKI	TITLE	DCU12
CHECKED	Oct. 18 '07	I. TAKENO	名称	ディスプレイコントロールユニット (卓上装備)
APPROVED	Oct. 22 '07	R. Esumi	外寸図	
SCALE	1/5	MASS 5.7 kg	NAME	DISPLAY CONTROL UNIT (TABLETOP MOUNT)
DWG.No.	C4446-G03-B	REF.No.	19-028-215C-3	OUTLINE DRAWING

注記

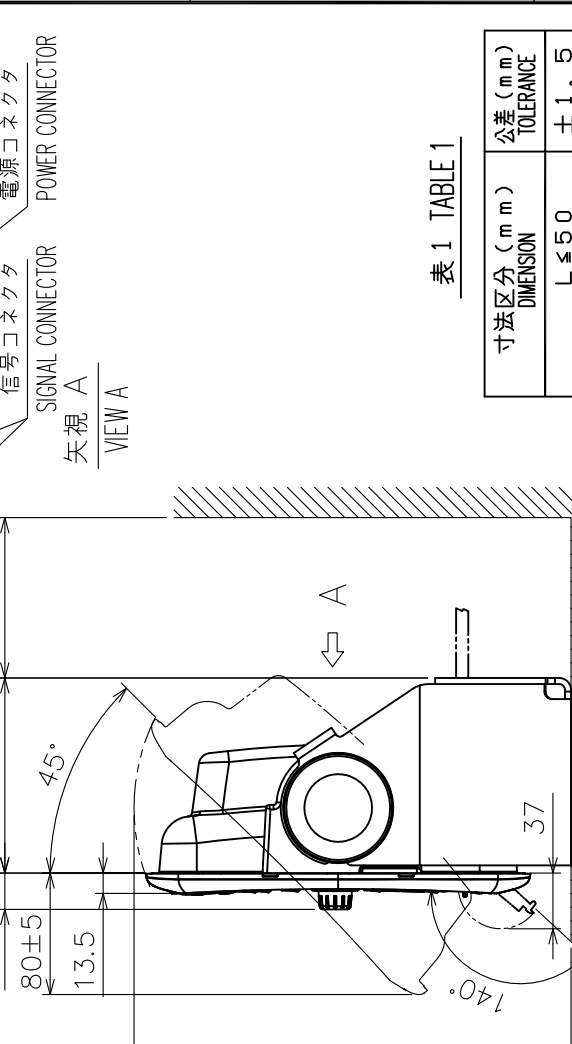
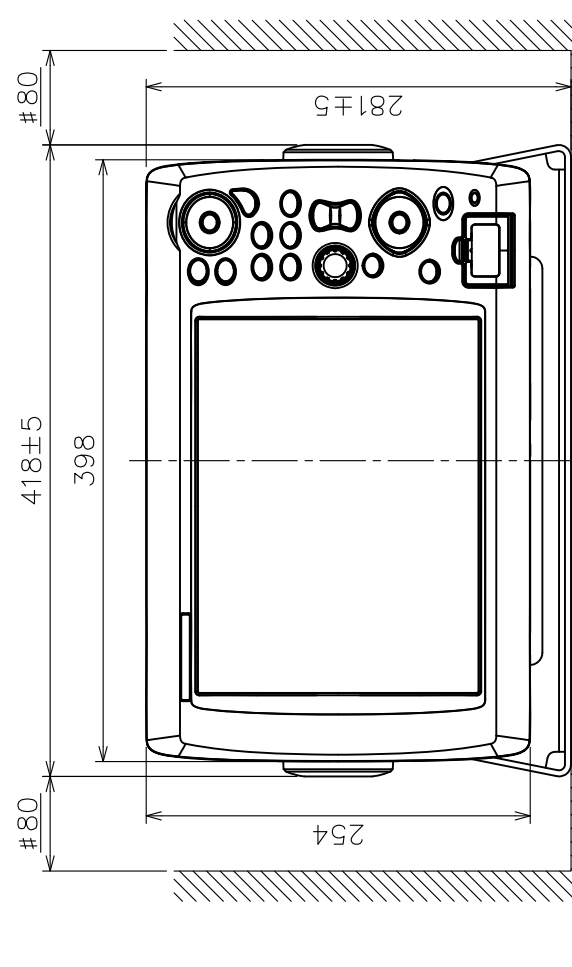
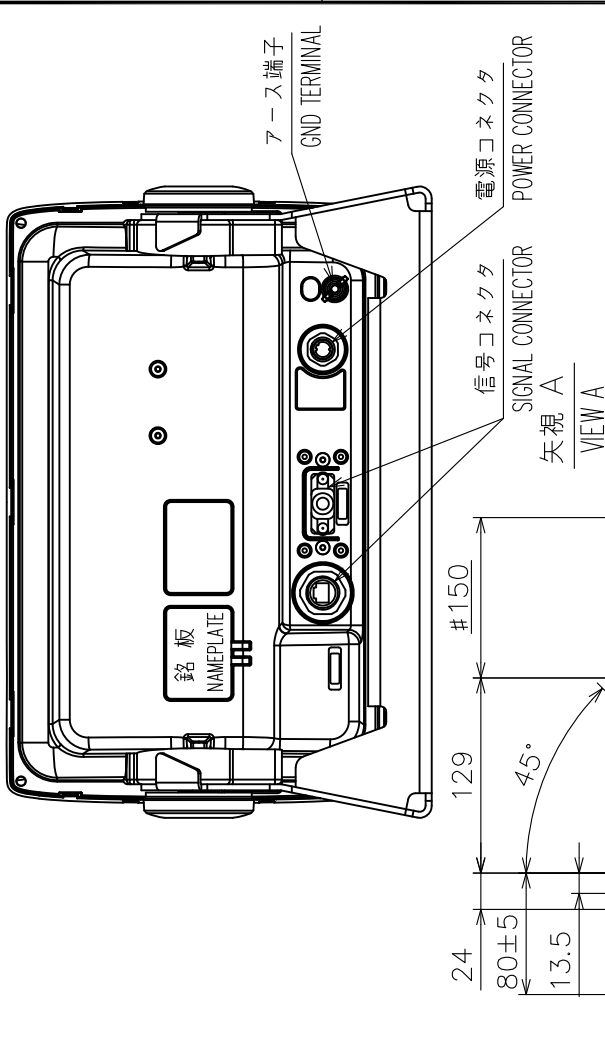
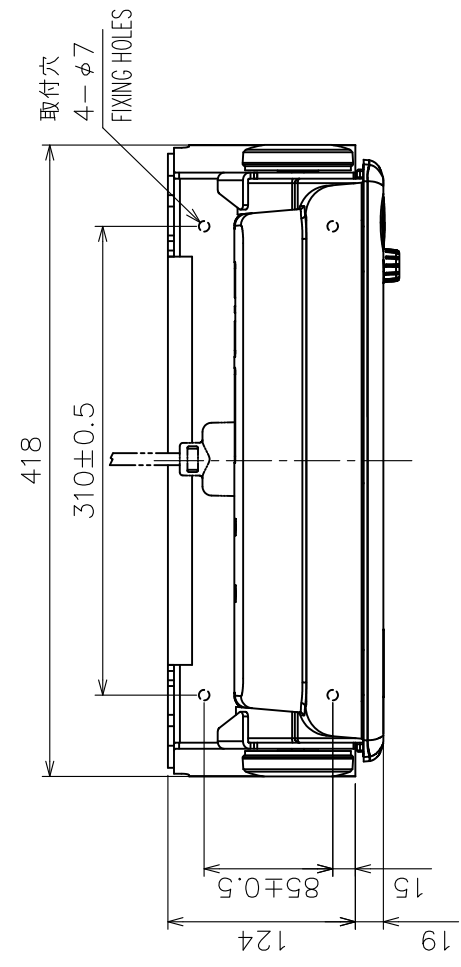
- 1) 印寸法は最小サービスクリアランスとする。
 - 2) 指定外の寸法公差は表 1 による。
 - 3) 取付には + トラスタッピングネジ 5 × 20 を使用のこと。
- NOTE
1. # MINIMUM SERVICE CLEARANCE.
 2. TABLE 1 INDICATES TOLERANCE OF DIMENSIONS WHICH IS NOT SPECIFIED.
 3. USE TAPPING SCREWS φ5x20 FOR FIXING THE UNIT.

表 1 TABLE 1

寸法区分 (mm) DIMENSION	公差 (mm) TOLERANCE
L ≤ 50	± 1.5
50 < L ≤ 100	± 2.5
100 < L ≤ 500	± 3

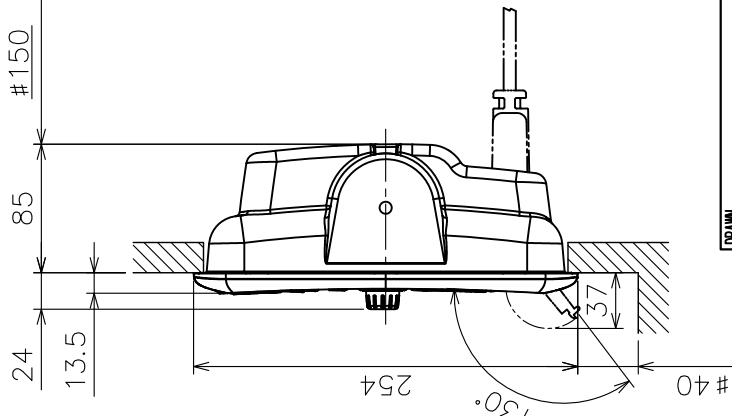
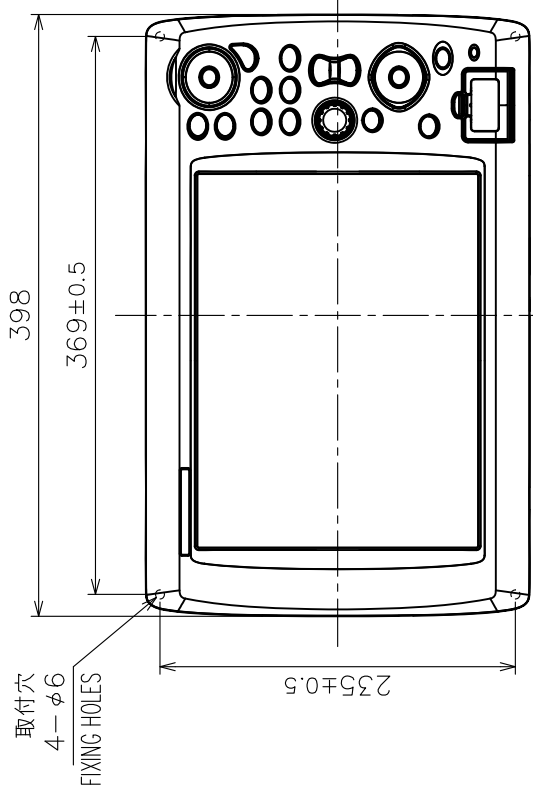
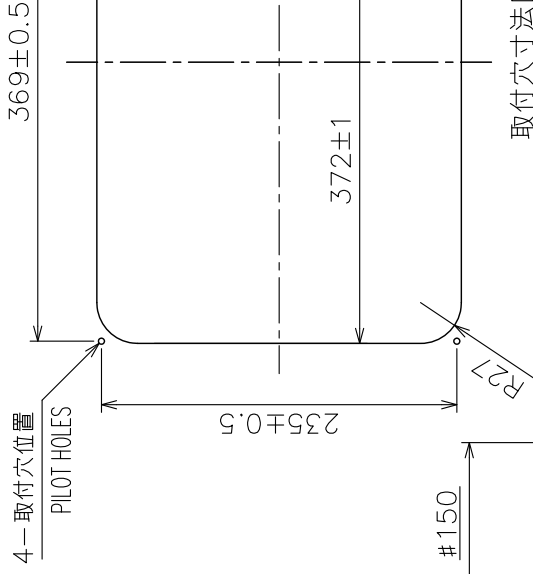
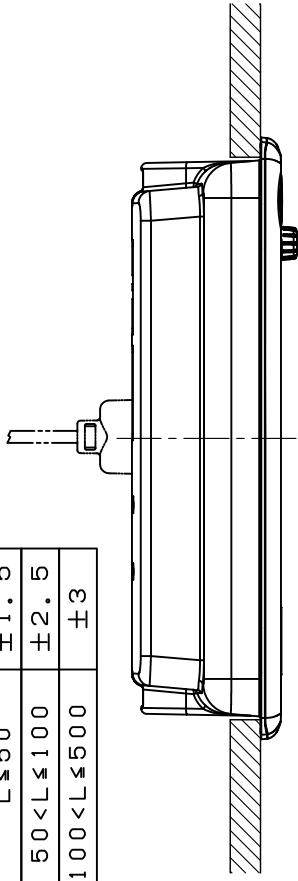

取付穴寸法図
CUTOUT DIMENSIONS

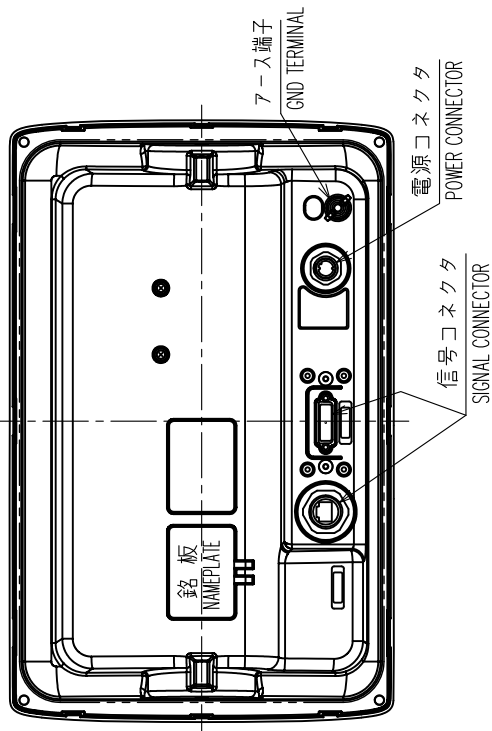

注記

- 1) #印寸法は最小サービス空間寸法とする。
- 2) 指定外の寸法公差は表 1 による。
- 3) 取付には + トラスタッピングネジ 5 × 20 を使用のこと。

NOTE

1. # MINIMUM SERVICE CLEARANCE.
2. TABLE 1 INDICATES TOLERANCE OF DIMENSIONS WHICH IS NOT SPECIFIED.
3. USE TAPPING SCREWS $\phi 5 \times 20$ FOR FIXING THE UNIT.

DRAWN	Oct. 17 '07	I. YAMASAKI	TITLE	DCU12
CHECKED	Oct. 18 '07	I. TAKENO	名称	ディスプレイコントロールユニット (埋込装備)
APPROVED	Oct. 22 '07	R. Esumi	外寸図	
SCALE	1/5	MASS 4.2 kg	NAME	DISPLAY CONTROL UNIT (FLUSH MOUNT)
DWG. No.	C4446-G04-B	REF. No.	19-028-210G-2	OUTLINE DRAWING

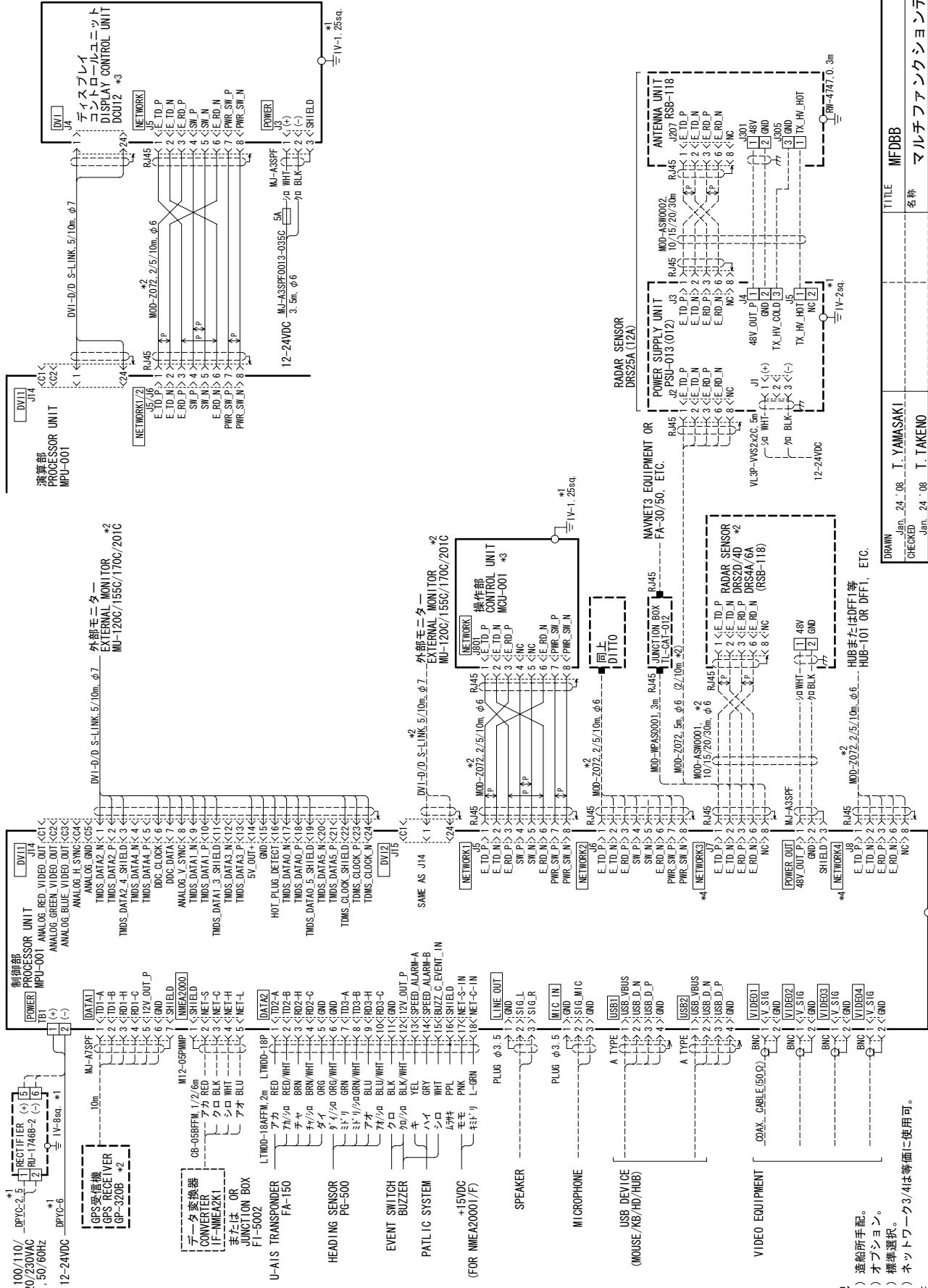

注記
 * 1) 造船所手配。
 * 2) オプション。
 * 3) 標準選択。
 * 4) ネットワーク3/4は等価に使用可。

NOTE
 *1: SHIPYARD SUPPLY.
 *2: OPTION.
 *3: SELECTABLE STANDARD.
 *4: NETWORK 3/4 ARE USED EQUIVALENTLY.

DRAWN	Jan. 24 '08	T. YAMASAKI	TITLE	MFDDBB
CHECKED	Jan. 24 '08	T. TAKENO	名称	マルチファンクションディスプレイ
APPROVED	Feb. 20 '08	R. Esumi	相互接続図	
SCALE		MASS	NAME	MULTI-FUNCTION DISPLAY
DWG No.		kg	REF. No.	19-028-7003-2
				INTERCONNECTION DIAGRAM

ECF

(Elemental Chlorine Free)

The paper used in this manual
is elemental chlorine free.

FURUNO ELECTRIC CO., LTD.

9-52 Ashihara-cho,
Nishinomiya, 662-8580, JAPAN

Telephone : +81-(0) 798-65-2111

Fax : +81-(0) 798-65-4200

• FURUNO Authorized Distributor/Dealer

All rights reserved. Printed in Japan

Pub. No. IME-44460-A

(HIMA) MFDBB

A : APR. 2008

D : JAN, 2011



* 0 0 0 1 6 7 2 2 2 1 0 *