

MC35

User Guide with Windows Mobile[®] 6



MC35

User Guide for Windows Mobile® 6

COPYRIGHT

© 2015 ZIH Corp

No part of this publication may be reproduced or used in any form, or by any electrical or mechanical means, without permission in writing from Zebra. This includes electronic or mechanical means, such as photocopying, recording, or information storage and retrieval systems. The material in this manual is subject to change without notice.

The software is provided strictly on an "as is" basis. All software, including firmware, furnished to the user is on a licensed basis. Zebra grants to the user a non-transferable and non-exclusive license to use each software or firmware program delivered hereunder (licensed program). Except as noted below, such license may not be assigned, sublicensed, or otherwise transferred by the user without prior written consent of Zebra. No right to copy a licensed program in whole or in part is granted, except as permitted under copyright law. The user shall not modify, merge, or incorporate any form or portion of a licensed program with other program material, create a derivative work from a licensed program, or use a licensed program in a network without written permission from Zebra. The user agrees to maintain Zebra's copyright notice on the licensed programs delivered hereunder, and to include the same on any authorized copies it makes, in whole or in part. The user agrees not to decompile, disassemble, decode, or reverse engineer any licensed program delivered to the user or any portion thereof.

Zebra reserves the right to make changes to any software or product to improve reliability, function, or design.

Zebra does not assume any product liability arising out of, or in connection with, the application or use of any product, circuit, or application described herein.

No license is granted, either expressly or by implication, estoppel, or otherwise under any Zebra, intellectual property rights. An implied license only exists for equipment, circuits, and subsystems contained in Zebra products.

Welcome

Thank you for making MC35 your choice for your mobile computing and communication needs. Your new sleek MC35 is a fully integrated EDA-mobile phone device. It combines the power of high-performance EDA applications for organizing personal and work-related information with the connectivity function of a mobile phone. The device also supports high-speed General Packet Radio Services (GPRS) for on-the-go Internet access, as well as a high quality Global Positioning System (GPS) solution to meet your travel needs. Selected MC35 models have a built-in camera for taking pictures and bar code data capture. All these features make your MC35 the ideal digital companion for both work and play.

Welcome

Contents

Welcome	v
1 First Things First	1
Package contents	1
Preparing to use your MC35	1
Installing the battery pack	1
Charging the MC35	2
Installing Microsoft ActiveSync	3
Starting the MC35	4
Creating an ActiveSync partnership	4
2 System Tour	7
Features summary	7
Performance	7
Display	7
Audio	7
Mobile connectivity	7
Hardware connectivity	8
Battery pack	8
Design and ergonomics	8
Accessories	9
Hardware tour	10
Hardware interface	12
Using the touch screen backlight key	12
Using the stylus	12
Using the SD/MMC expansion slot	12
Soft buttons and keypad	14
Command interface	17
Today screen	17
Start menu	18
Navigation bar	18
Command bar	20
Pop-up menus	20
Notifications	21
3 Entering Information	23
Using the MC35 keypad	23
Using the Input Selector	23
Keyboard	24
Block Recognizer	25
Letter Recognizer	25
Transcriber	26
Star Key	27
Writing on the screen	27
Drawing on the screen	28
Recording a message	29
Using My Text	30
Using ActiveSync	31
Synchronizing information with your computer	31
Synchronizing with a server	35
Using ActiveSync to copy files	37
Synchronization options	37
ActiveSync errors	38
Using wireless communication	38
4 Managing Information	39
Opening programs	39
Program list	40
Using Search	42
Using File Explorer	43
5 Wireless Communications	45
Wireless communication features	45
Beam function	45

GPRS connection51
Wi-Fi connection52
Managing wireless connections57
Using Wireless Manager57
Getting connected60
Connecting to the Internet60
Connecting to your office network61
Viewing intranet URLs62
Setting an e-mail server connection63
6 Using the Windows Mobile Programs	65
Microsoft Outlook Mobile programs65
Calendar65
Contacts68
Tasks72
Notes74
Messaging76
Microsoft Office Mobile programs80
Word Mobile80
Excel Mobile83
PowerPoint Mobile85
Windows Media Player88
Copying files to your device88
The library89
The playlist89
File Playback92
Customizing the Player94
Internet Explorer Mobile98
Windows Live	101
Live Hotmail	103
Live Messenger	105
Live Sync	107
7 Using Phone	109
Phone setup	109
Installing the SIM card	109
Entering your PIN	111
Dialer screen	112
Dialer buttons	112
Phone status icons	113
Phone operation	113
Turning the phone function on and off	113
Erasing number input	115
Answering a call	116
Rejecting a call	116
Ending a call	116
Adjusting the phone volume	116
Using the speakerphone	116
Muting a call	117
Making phone calls	117
Phone features	121
Call notification and identification	122
Call hold	122
Conference call	123
Call notes	123
Text messaging service	125
Voice mail	129
Contacts integration	130
Call History	132
Phone profiles	135
Phone preferences	137
Phone tab	138
Services tab	140
Network tab	145
Band tab	146

PPP Auth tab	147
8 Using GPS Navigation	149
GPS antenna	149
Unpacking the MC35 vehicle mount kit	149
Setting up MC35 on your vehicle	149
Installation reminders	149
Downloading the LTO satellite data	151
Using MC35 safely	153
9 Using MC35 Companion Programs	155
Phone management programs	155
SIM Manager	155
SIM Toolkit	157
Gain Adjust	158
Wireless communication programs	158
Internet Sharing	158
Push to Talk	161
Remote Desktop Mobile	169
Express GPS Connect	171
Media-related programs	176
Pictures & Videos	176
Camera	184
CamWedge	189
Product download-related programs	193
AirBEAM Smart	193
RD Client Version	201
MSP Agent	210
Certificate Import	217
10 Customizing your MC35	219
Adjusting system preferences	219
Personal tab	219
System tab	224
Connections tab	232
Program management	235
Adding programs to your device	235
Running programs from the SD card	237
Removing programs	237
SD driver management	238
Setting the SD driver	238
11 User Support	241
Customer support	241
Protecting your MC35	242
Using system locks	242
Creating backup files	243
Troubleshooting	245
Troubleshooting reminders	245
Troubleshooting procedures	245
Recalibrating the screen	250
Resetting your MC35	251
Checking the OS version of your device	252
Battery pack information	253
Index	255

1 First Things First

- Package contents
- Preparing to use your MC35

Package contents

Your MC35 comes packed in a cardboard box. Carefully unpack the box and remove the contents. If any of the following items are missing or damaged, contact your dealer immediately.

- MC35 Enterprise Digital Assistant
- Stylus
- Standard life battery
- AC adapter (with four region-specific clip plugs)
- USB sync cable
- MC35 Quick Start Guide
- MC35 Regulatory Guide

Preparing to use your MC35

Perform the following easy setup tasks to begin using your device:

- 1 Install the battery pack.
- 2 Charge your device.
- 3 Install ActiveSync 4.2 or higher on your computer.
- 4 Start the MC35.
- 5 Create an ActiveSync partnership between your device and your computer.

Installing the battery pack

Your MC35 uses a high-density removable and rechargeable 1370 mAh lithium polymer/standard life battery. See "Battery problem" on page 245 for more information on how to conserve power consumption to make your battery last longer.

NOTE: An optional 2740 mAh extended life battery is available.

WARNING! There is a risk of fire and burns if the battery is handled improperly. DO NOT disassemble, crush, puncture, short external contacts, or dispose the battery in fire or water. DO NOT attempt to open or service the battery. Dispose of used batteries according to local recycling guidelines in your area.

1 First Things First



Preparing to use your MC35

To install the battery pack:

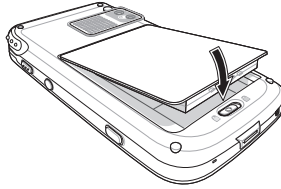
Align the tabs on the battery pack with the grooves on the rear side of the device, and then insert the battery pack in place. The battery pack locks to the chassis with an audible click.



To uninstall the battery pack:

- 1 If the device is on, press the **Power** button  to turn off the device. Wait for five seconds to allow the device to completely power off.
- 2 Slide the battery latch toward the **unlock** icon  to release the battery pack from the chassis **(1)**.
- 3 Completely detach the battery pack from the device **(2)**.

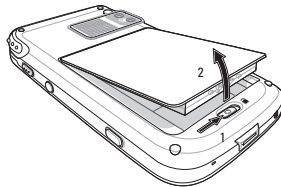

Charging the MC35

Initial charging of a standard life battery takes about four hours. The extended life battery type requires at least eight hours. After the initial charging, charge your device everyday to restore the battery to full capacity. Charge your device using the AC adapter cable, see instructions below.

While waiting for the initial charging to complete, install Microsoft® ActiveSync® 4.2 or higher on your computer to prepare for the initial synchronization procedure. Refer to the next section for instructions.

To charge your device:

NOTE: Use the clip plug applicable in your country.

- 1 Slide the replaceable clip plug into the AC adapter until it locks into place with an audible click.

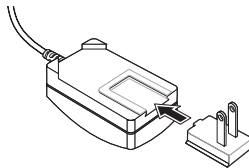

- 2 Plug the AC adapter cable into the mini USB connector on bottom of the device.
- 3 Connect the AC adapter cable into an electrical outlet.

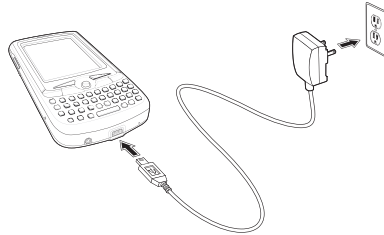

The LED indicator on the right side of the touch screen lights up orange to signify that AC connection is made.

If the battery level becomes low in the course of normal use, a **status** icon appears on the device screen indicating low or depleted battery status (see "Status icons" on page 18 for more information). In both cases, perform an ActiveSync operation to back up your data, and then recharge your device as soon as possible.

If the battery level reaches low status, the device enters *sleep mode*; if the battery level reaches very low status, the device enters *deep sleep mode*. In this case, you have about 72 hours to recharge your device after which you risk losing all data on your device's internal memory.

Installing Microsoft ActiveSync

ActiveSync is already installed on your MC35; you only need to install it on your computer.

System installation requirements

- Supported operating systems:
 - Windows 2000 Service Pack 4
 - Windows Server® 2003 Service Pack 1
 - Windows Server 2003 Service Pack 1 for Itanium-based Systems
 - Windows Server 2003, Standard x64 Edition
 - Windows XP® Media Center Edition
 - Windows XP Professional x64 Edition
 - Windows XP Service Pack 1
 - Windows XP Service Pack 2
 - Windows XP Tablet PC Edition
- Microsoft Outlook® 2000, Microsoft Outlook XP, or Microsoft Outlook® 2003 (recommended) messaging and collaboration clients required for Microsoft Outlook Office Mobile synchronization
- Microsoft Office 2000, Microsoft Office XP or Microsoft Office 2003 for Microsoft Office Mobile® synchronization
- Microsoft Internet Explorer 6.0 or later for Internet Explorer Mobile favorites synchronization
- Microsoft Systems Management Server 2.0
- Hard disk drive with 7 MB of available hard disk space (actual requirements may vary based on selected features and user's current system configuration)
- USB port, Bluetooth, or infrared connection

1 First Things First

Preparing to use your MC35

To install Microsoft ActiveSync on your computer:

- 1 Close all open programs, including those that run at startup, and disable any virus-scanning software.
- 2 Download the ActiveSync setup software from the Microsoft ActiveSync Download page at <http://www.microsoft.com>.
- 3 On the download prompt, click **Open**.
- 4 Follow all on-screen instructions to complete installation.

To confirm you've successfully installed ActiveSync, open ActiveSync, then click **Help > About Microsoft ActiveSync**.

For detailed information about using ActiveSync on your computer, start ActiveSync on your computer, click **Help > Microsoft ActiveSync Help**.

Starting the MC35

After you have initially charged your device, the device is ready for use. You can now start your device where you will calibrate the display, learn basic stylus usage, and set up the system date and time.

To start your MC35:

NOTE: After pressing the power button, wait four seconds for the device to power on before pressing the power button again.

- 1 Turn on your device by pressing the **Power** button  located on the right side of the touch screen.



- 2 Follow the on-screen Welcome Screen Wizard instructions.
- 3 After the device setup, create an ActiveSync partnership to synchronize information between your computer and/or server and your MC35.

Creating an ActiveSync partnership

After installing ActiveSync on your computer and completing the device setup, you can now set up a partnership between your MC35 (first time connection only) and your computer and/or a server with the help of the New Partnership setup wizard. This wizard will help you:

- Set up a partnership so you can synchronize information between your device and your computer
- Customize your synchronization settings

To create an ActiveSync partnership:

- 1 Connect the USB sync cable into the connector on the bottom of your device, then plug the USB sync cable into a USB port on your computer.

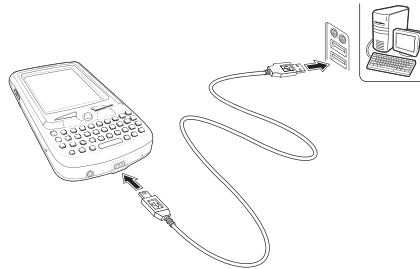

The Synchronization Setup Wizard automatically starts on your computer screen.

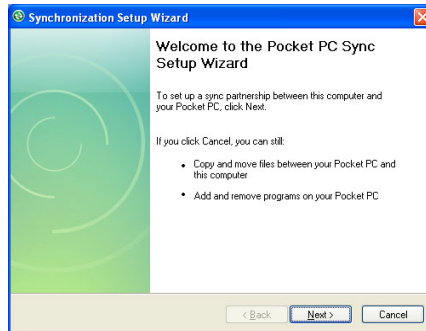

NOTE: If the wizard does not automatically appear, launch ActiveSync on your computer by clicking on its icon from **Start > Programs**.

- 2 Follow the on-screen instructions.
To prevent synchronization problems, select the "Synchronize directly with a server running Microsoft Exchange Server..." option only if you are certain that your company is running Microsoft Exchange Server with Exchange ActiveSync and you know the server address and logon credentials. For more information, contact your corporate network administrator or service provider.
By default, ActiveSync only synchronize information for Contacts, Calendar, Messaging (Outlook E-Mail), Tasks, and Favorites (for Internet Explorer Mobile). If you decide to synchronize other files, for example, Word documents, ActiveSync need to convert these files. Converted files may not contain all information found in original file.

1 First Things First

Preparing to use your MC35

- 3 Click **Finish** to close the wizard and start the initial synchronization. During the synchronization process, the ActiveSync window appears on your computer, while the **Data connectivity** icon  appears on your device's navigation bar.

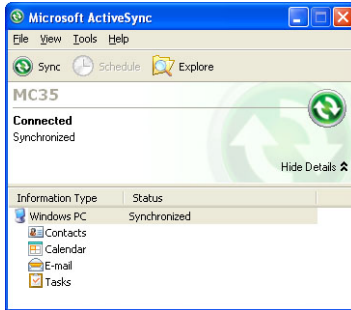

After the initial synchronization, the information types you've selected for synchronization are copied to your device. Disconnect your device from your computer and you're ready to go!

The next time you connect your device, your computer recognizes it automatically. You don't need to set up the partnership again. You can initiate synchronization from your device anytime via several connection options—via USB sync cable, infrared, or Bluetooth connections. For more information on these connection options and other ActiveSync configuration settings, see "Using ActiveSync" on page 23.

2 System Tour

- Features summary
- System tour
- Hardware interface
- Command interface

Features summary

Listed below are the MC35 key features and specifications.

Performance

- Intel® PXA270 processor with speed of up to 416 MHz
- Integrated Intel XScale™ Technology
- System memory:
 - 128 MB SDRAM for application storage
 - 128 MB Flash ROM
- Microsoft Windows Mobile™ 6 Professional software
- Microsoft ActiveSync technology for data synchronization
- Express GPS Connect for Assisted Global Positioning System (AGPS) function
- Available configuration models

Model	Part number
• WAN/PAN/GPS	• MC35-B
• WAN/PAN/GPS/Camera	• MC35-C
• WAN/PAN/LAN/GPS	• MC35-L
• WAN/PAN/LAN/GPS/Camera	• MC35-CL

Display

- 2.8" transreflective Thin Film Transistor Liquid Crystal Display (TFT LCD)
- Quarter Video Graphics Array (QVGA) resolution
- 65 K color depth support
- Hardware and software backlight controls
- Microsoft ClearType technology for clearer, crisper font display

Audio

- Embedded AC '97 CODEC with CD-quality stereo output
- Built-in industry-standard 2.5-mm earphone jack
- Built-in speaker and microphone
- Separate volume control for system sounds and phone function
- Playback support for both Windows Media and MIDI sound files for personalizing ring tones and sound notifications

Mobile connectivity

- Phone function
 - Quad-band GSM broadband function (850/900/1800/1900 MHz)
 - Customizable ring tones and ringer options
 - Hardware and software launch options

2 System Tour

Features summary

- Wireless connectivity
 - IrDA standard Infrared (IR) sensor for short-range file exchange
 - Bluetooth for personal area network (PAN) connection
 - High-speed GPRS for mobile Internet access via GSM network
 - Optional Wi-Fi (IEEE 802.11b/g) hardware for wireless local area network (WLAN) connection

Hardware connectivity

- Mini USB B connector
- SD/MMC expansion slot
- 2.5-mm earphone jack (four-wire)
- Optional 2.0 megapixel micro/macro dual focus digital camera

Battery pack

- Removable and rechargeable 1370 mAh standard life or 2740 mAh extended life battery pack
- Charging time from empty to full capacity:
 - Standard life battery: four hours
 - Extended life battery: eight hours
- Operation time (in hours)

	Standard life battery (default)	Extended life battery (optional)
• Talktime	4	8
• Standby	150	300
• MP3 playback	12	24
• WMV playback time	8	16
• Internet browsing time (WLAN)	4	8
• GPS usage	8	16

Conditions:

- MP3 playback time measured with the backlight off.
- WMV playback time measured with the backlight on and phone off.

NOTE: Length of battery operation depends on power consumption which in turn is based on system resources use. For example, constantly using the backlight or using power-demanding applications shortens the length of battery operation.

Design and ergonomics

- Stylish and sleek design
- Dimensions
 - Length: 127 mm (5 inches)
 - Width: 66 mm (2.6 inches)
 - Depth: 19 mm (0.51 inches)
 - Weight (approximately, with battery pack): 179 g (6.3 oz.)

- User-friendly navigation features
 - Joystick for one-hand operation
 - Volume button for system volume control
 - Push To Talk button for voice recordings and PTT calls. This button is only available for PTT when PTT service is provided by your carrier. Contact your mobile phone service provider about feature availability. The PTT button can also be set to launch another program. Tap **Start > Settings > Personal > Buttons** to customize this button
 - Camera/Bar Code switch for enabling camera or data capture mode
 - Camera button for launching the Pictures & Videos program

Accessories

- Vehicle kit (includes the auto mounting kit, auto charger and hands-free headset)
- Leather case
- USB charge/sync cable
- Travel charger
- Hands-free headset (earbuds)
- Protective boot
- Stylus 3-pack
- Standard life battery
- Extended life battery

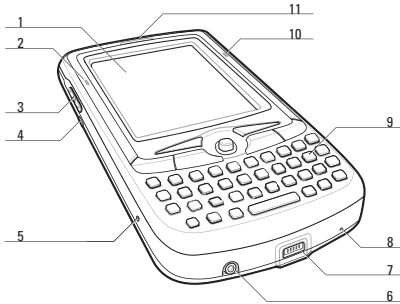

Hardware tour

This section is a descriptive tour of the MC35 hardware interface.

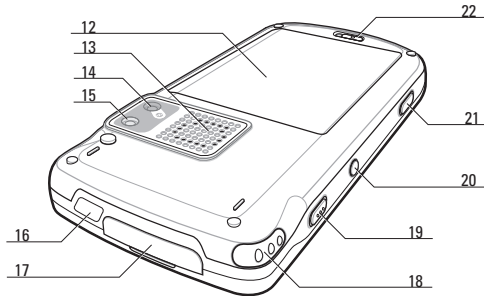

No.	Component	Description
1	LCD touch screen	Displays the applications and data stored on your device. It is touch-sensitive and responds to the stylus or your finger.
2	GSM status/ notification LED	<ul style="list-style-type: none">Fast flashing green - indicates GSM activity.Solid green - indicates voice call in progress.Flashing red - indicates system alarms or reminders.
3	Volume up/down button (system volume only)	Press the top key to increase volume, press the bottom key to decrease volume.
4	Camera/Bar Code switch 	Toggles the camera lens mode from bar code data capture to camera mode (for device configurations with camera function only).
5	Reset button	Press the tip of the stylus into the button to reset your device.
6	Earphone jack	Connects to an audio line-out device such as earphones or headphones.
7	Connector	<ul style="list-style-type: none">For ActiveSync operation - accepts the USB sync cable, which in turn connects to a computer's USB port.For recharging - accepts the AC adapter cable.
8	Microphone	Inputs audio into your device during phone calls or when recording voice notes.
9	Keypad	Key in alphanumeric characters. It also supports special keys for launching phone/messaging functions, as well as for backlight control.
10	Charging LED	Lights up orange during battery charging.
11	Phone speaker	Listen to a phone call from here.



No.	Component	Description
12	Main battery	Removable and rechargeable battery pack.
13	System speaker	Listen to multimedia files here. When the speakerphone is active, sounds are emitted here.
14	Camera lens (optional)	Take pictures or captures bar code data.
15	Camera flash (optional)	Provides illumination when taking pictures in low light conditions.
16	IR port	Uses infrared technology to transmit and receive data from other IR-enabled devices.
17	SD/MMC expansion slot	<p>Supports SD/MMC/SDIO storage cards allowing you to expand the device memory capacity.</p> <p>Install add-on applications or use files stored in it for use with internal applications. You can also use it to back up data from your device.</p> <p>Note: This slot can be set to provide a quick switch between SDMMC or SDIO mode. Tap Start > Settings > System > SDSwitch  to customize this slot.</p>
18	Stylus	To use the stylus, remove it from its holder and hold it the same way you hold a pen or pencil.
19	Push To Talk button	<p>Press this button to create voice recordings. See "Recording a message" on page 23 for more information.</p> <p>Note: This button can be set to launch another program. Tap Start > Settings > Personal > Buttons  to customize this button.</p>
20	Power button	<p>Press to toggle the device on/off.</p> <p>Note: Wait four seconds after pressing the power button to allow the device to power on/off before pressing the power button again.</p>

2 System Tour

Hardware interface

No.	Component	Description
21	Camera button	Press to launch the Pictures & Videos program and take pictures or capture bar code data. Note: In MC35 configuration models with no camera function, this button can be set to launch another program. Tap Start > Settings > Personal > Buttons  to customize this button.
22	Battery release latch	Unlocks the battery pack from the chassis.

Hardware interface

This section explains basic hardware procedures and describes the MC35 keypad and function buttons.

Using the touch screen backlight key

Under some lighting conditions, viewing information on the LCD touch screen may be difficult. If this is the case, activate the backlight by tapping the screen or by pressing the Backlight key (not applicable when viewing the Today screen, the Dialer pad will instead be displayed).

Using the stylus

On your device, the stylus replaces the mouse.

- Tap - Touch the screen once with the stylus to open items and select options.
- Drag - Hold the stylus on the screen and drag across the screen to select text and images. Drag in a list to select multiple items.
- Tap and hold - Tap and hold the stylus on an item to see a list of actions available for that item. In the pop-up menu that appears, tap the action you want to perform.

Using the SD/MMC expansion slot

Your device has an expansion slot compatible with a range of SD and MMC storage cards, which are used to back up or transfer files and data or launching applications. The slot also supports SDIO cards for added connectivity options.

IMPORTANT: If you are running an application from an SD card, make sure to use the SDSwitch application to set the driver mode of the expansion slot to support SDMMC mode and enable the "No Remove On Resume" option. See "To set the SD driver mode to SDMMC mode" on page 238 for instructions. Refer to "SDSwitch" on page 230 for more information about the SDSwitch application.

To insert a storage card:

NOTE: This device comes with a protective plastic card in the card slot. Remove the plastic card from the slot before trying to insert a storage card.

- 1 Hold your device securely, then lift the rubber cover from the expansion slot .

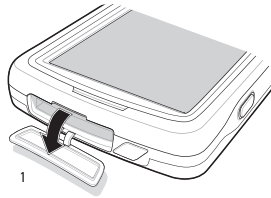

- 2 Slide the SD/MMC/SDIO card into the slot and push in until it locks into place. The card is secure when it is not protruding from the base.

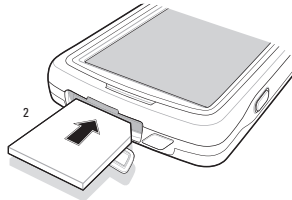

- 3 Insert the rubber cover back into place.

To remove a storage card:



- 1 Hold your device securely, then lift the rubber cover from the expansion slot .
- 2 Push against the top of the card, as if you were pushing it further into the slot, letting the card spring out. An audible system sound indicates that the card has been released.
- 3 Gently remove the card from the slot.
- 4 Close the rubber cover.

Soft buttons and keypad

The MC35 keypad has alphanumeric keys that produce the 26-character alphabet (A-Z, both lowercase and uppercase), numbers (0-9), and assorted special characters. The keypad is color-coded to indicate when the modifier key is pressed to produce a particular character or action. In addition to alphanumeric keys, the keypad also has soft buttons and special keys to launch particular applications, control the screen backlight, and display the on-screen keyboard.

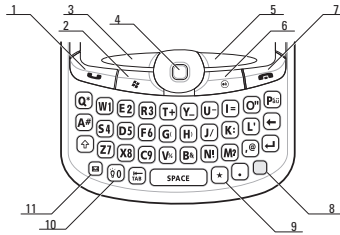
NOTE: The keypad illuminates when a key is pressed and stays lit for approximately five seconds.



No.	Component	Description
1	Send button 	<ul style="list-style-type: none"> When there's an incoming call, press to accept the call. During an ongoing call, press and hold to toggle on/off the speakerphone mode. From Speed Dial, press to call the currently selected number. From Call History, press to call the currently selected log item. In Messaging, press to send a composed e-mail/text message or display options for a received e-mail/text message. Change between an active call and call that is on hold.
2	Start button 	Press to display the Start menu.
3	Left soft button	Press to perform the function indicated on the lower left corner of the display.
4	Joystick	<ul style="list-style-type: none"> Press the center of the joystick to access menu options and confirm your selection. Move the joystick in a left, right, up or down direction to navigate through the menu options.
5	Right soft button	Press to perform the function indicated on the lower right corner of the display.
6	OK button 	Press to close the active program and display the Today screen.

No.	Component	Description
7	End button 	<ul style="list-style-type: none">• When there's an incoming call, press to reject the call.• During an ongoing call, press to end the call.• When manually dialing a number, press to delete the number input.• Press and hold for at least five seconds to toggle the Flight Mode and Wireless connections on/off. See "Managing wireless connections" on page 57 for more information.
8	Orange key	<p>Use this key to enable the secondary keypad characters/functions.</p> <ul style="list-style-type: none">• To type a special character, press the Orange key and secondary character key. To illustrate, pressing the Orange key, then J will allow you to type a slash (/).• Press the Orange key twice to lock the keypad in secondary character/action mode. Press the Orange key again to revert to the default keypad mode (alphabetic, lower-case).• Press and hold the Orange key while entering characters or actions.
9	Star key	Press this key to display the on-screen keyboard.
10	Backlight/0 key	<ul style="list-style-type: none">• Press this key to adjust the touch screen backlight.• Press the Orange key, then this key to type the zero '0' character.• In the Today screen, press this key to display the Dialer pad.
11	Messaging key	Press this key to launch the Messaging program. See "Messaging" on page 76 for more information.

2 System Tour

Hardware interface

Secondary keypad input mode

Key	Default input	Keystroke combination	
		Shift or CAPS + Key	Orange + Key
Q	q	Q	*
W	w	W	1
E	e	E	2
R	r	R	3
T	t	T	+
Y	y	Y	-
U	u	U	-
I	i	I	=
O	o	O	"
P	p	P	áü
A	a	A	#
S	s	S	4
D	d	D	5
F	f	F	6
G	g	G	(
H	h	H)
J	j	J	/
K	k	K	:
L	l	L	'
Z	z	Z	7
X	x	X	8
C	c	C	9
V	v	V	%
B	b	B	&
N	n	N	!
M	m	M	?
,	,	,	@
Brightness	Brightness	Brightness	0

Note: The following keys only have one action: Backspace, Shift, Enter, Messaging, Tab, Space, and Star.

Command interface

This section explains the MC35 command interface.

Today screen

When you turn on your device for the first time each day (or after a preset period of inactivity), you'll see the Today screen. This screen provides an at-a glance view of the day's important reminders and status.

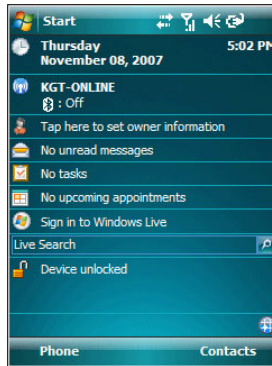

To display the Today screen:

- When viewing another screen, press the **OK** button or tap **Start** > **Today**.
- You can also define a preset period of inactivity after which the Today screen is displayed. Follow the steps below.
 - 1 Tap **Start** > **Settings**.
 - 2 On the **Personal** tab, tap **Today**.
 - 3 On the **Items** tab, select the "Today timeout" option.
 - 4 Tap the pick list beside the check box to set the period of inactivity.
 - 5 Tap **ok**.

To customize the Today screen:

- 1 Tap **Start** > **Settings**.
- 2 On the **Personal** tab, tap **Today**.

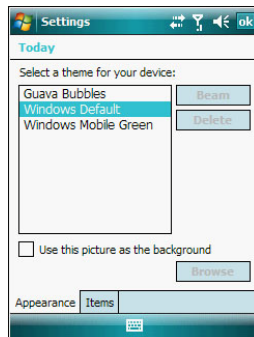

- 3 On the **Appearance** tab, tap the "Use this picture as background" check box.

2 System Tour

Command interface

- 4 Tap **Browse** to select a picture from the pictures stored in your device.
- 5 Tap **ok**.

Start menu

The Start menu displays a list of active programs, as well as options to view the Programs, Settings, and Help screens.

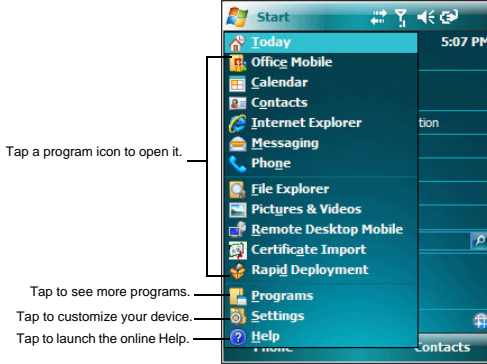

Navigation bar

The navigation bar is located on the top of the screen. It shows the status icons for the battery, volume, and data connectivity. Notifications icons for system alarms and reminders are also displayed here.





















Status icons

The table below describes some of the status icons you may see on the navigation bar.



NOTE: See "Phone status icons" on page 109 for more information on the status icons related to the phone function.

Icon	Description
	Speaker on
	Speaker off
	Vibrate mode
	Battery level
	Battery charging
	Battery is low

Icon	Description
	Battery power completely depleted
	Notification ¹ that one or more instant messages were received
	Notification that one or more e-mail/text messages were received
	Pending alarm
	Data call in progress
	Synchronization error
	<ul style="list-style-type: none"> No data connection. Tap to activate the device's Phone, Wi-Fi, Bluetooth, or cellular data GPRS connection. Device is not synchronized with a computer
	<ul style="list-style-type: none"> Data connection is active Phone and wireless features, such as Bluetooth or GPRS; on your device are turned on. Device is synchronized with a computer
	<ul style="list-style-type: none"> Data connection is active Wi-Fi network on your device is turned on Device is synchronized with a computer
	Roaming
	GPRS network is available
	GPRS data connection is active
	GPRS signal status
	ActiveSync over GPRS in use
	EDGE (Enhanced Data rates for GSM Evolution) network is available
	EDGE data connection is active
	ActiveSync over EDGE in use
	Wi-Fi on
	Wi-Fi data call

2 System Tour

Command interface

Icon	Description
	Bluetooth
	Bluetooth audio

1 If more notification icons need to be displayed than there is room to display them, the **Notification** icon appears on the command bar. Tap **Notification** to view all notification icons.

Command bar

Use the command bar at the bottom of the screen to perform tasks in programs. The command bar includes menu names, buttons, and the Input Selector button .

- To create a new item in the current program, tap **New**.
- To view a notification or an image file received on your device, tap **View**.
- To see the name of a button, tap and hold the stylus on the button. Drag the stylus off the button so that the command is not carried out.



Pop-up menus

With pop-up menus, you can quickly choose an action for an item. For example, you can use the pop-up menu in the contact list to quickly delete a contact, make a copy of a contact, or send an e-mail message to a contact. The actions in the pop-up menus vary from program to program.

To display a pop-up menu:

- 1 Tap and hold the stylus on the item that you want to perform the action on.
- 2 When the menu appears, lift the stylus then:
 - Tap the action you want to perform.
 - Tap anywhere outside the menu to close the menu without performing an action.

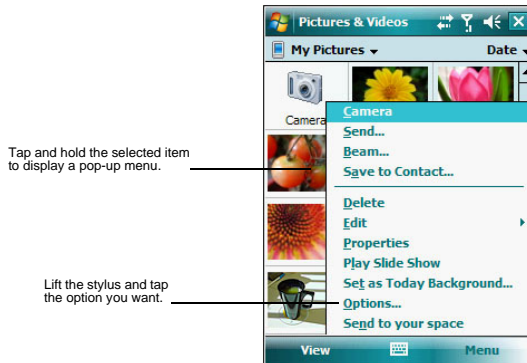



Notifications

Your device reminds you in a variety of ways when you have something to do or receive a message. For example, if you've set up an appointment in Calendar, a task with a due date in Tasks, or an alarm in Clock & Alarms, you'll be notified in any of the following ways:

- A message box appears on the screen.
- A sound, which you can specify, is played.

To choose reminder types and sounds for your device:

- 1 Tap  > **Settings** .
- 2 On the Personal tab, tap **Sounds & Notifications** .
- 3 On the Sounds tab, select the kind of events you want to be notified of.
- 4 On the Notifications tab, select the manner of notification you prefer for each event.
- 5 Tap **ok**.

3 Entering Information

- Using the MC35 keypad
- Using the Input Selector
- Writing on the screen
- Drawing on the screen
- Creating a recording
- Using My Text
- Using ActiveSync
- Using wireless communication

Using the MC35 keypad

The MC35 keypad has alphanumeric keys that produce the 26-character alphabet (A-Z, both lowercase and uppercase), numbers (0-9), and assorted special characters. In addition to alphanumeric keys, the keypad also has function buttons and special keys that perform specific action. See "Soft buttons and keypad" on page 14 for more information.

Using the Input Selector

Use Input Selector to enter typed text in any program where text entry is possible. You can either tap the keys on an on-screen keyboard or by use any of the handwriting recognition options.

To show or hide the Input Selector:

- Tap the **Input Selector**  arrow, then select an input option.

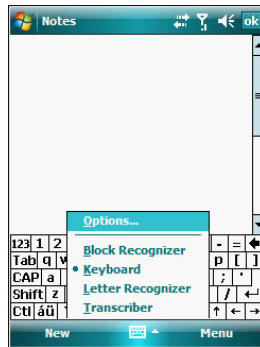



Word Completion

When you use the Input Selector, your device anticipates the word you are typing or writing and displays it above the Input Selector  arrow. When you tap the displayed word, it is inserted into your text at the insertion point. The more you use your device, the more words it learns to anticipate.

3 Entering Information *Using the Input Selector*

To define the **Word Completion** settings:

- 1 Tap  **Settings** .
- 2 On the **Personal** tab, tap **Input** .
- 3 On the **Word Completion** tab, define the word suggestion settings.

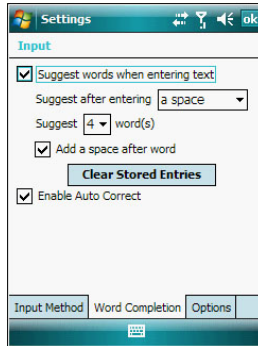

- 4 Tap **ok**.

Keyboard

The soft keyboard allows you to “type” information just like in a regular keyboard by tapping the on-screen keys.

To use the soft keyboard:

- 1 Tap the **Input Selector**  arrow, then select **Keyboard**; or you can press the **Star** key on the MC35 keypad.

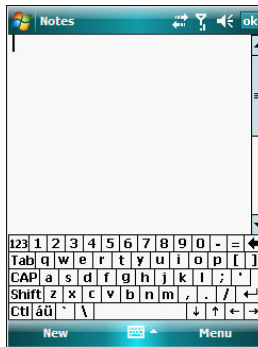

- 2 On the soft keyboard that is displayed, tap the keys with your stylus.

TIP: To make the keys larger, tap the **Input Selector**  arrow, and then **Options**. In the Input method list, select **Keyboard**, and then tap **Large Keys**.

Block Recognizer

With Block Recognizer, you use a single stroke to write letters, numbers, symbols, and punctuation, which are then converted into typed text.

To use Block Recognizer:

- 1 Tap the **Input Selector**  arrow, then select **Block Recognizer**.

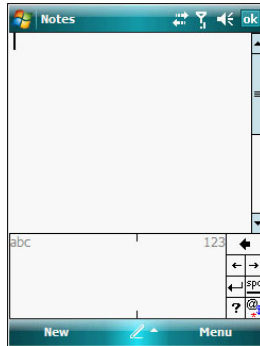

- 2 Write characters, numbers, and symbols in the designated writing area.
 - Enter letters by writing in the abc (left) area of the box
 - Enter numbers by writing in the 123 (right) area of the box.
 - Enter symbols and punctuation by tapping in either area of the box and then writing the desired character.

TIP: For help with writing characters with Block Recognizer, tap the **question mark** near the writing area.

Letter Recognizer

With Letter Recognizer, you can write individual letters, numbers, and punctuation and have them converted into typed text.

To use Letter Recognizer:

- 1 Tap the **Input Selector**  arrow, then select **Letter Recognizer**.

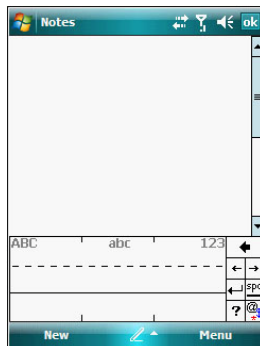

3 Entering Information

Using the Input Selector

- 2 Write characters, numbers, and symbols in the designated writing area.
 - Enter capital letters by writing in the ABC (left) area of the box.
 - Enter lower case letters by writing in the abc (middle) area of the box.
 - Enter numbers by writing in the 123 (right) area of the box.
 - Enter punctuation and symbols by tapping in either area of the box and then writing the desired character.

TIP: For help with writing characters with Letter Recognizer, tap the **question mark** near the writing area.

Transcriber

Transcriber allows you to write anywhere on the screen using the stylus just as you would on paper. It recognizes cursive or printed handwriting, or a combination of both.

To use Transcriber:

- 1 Tap the **Input Selector**  arrow, then select **Transcriber**.

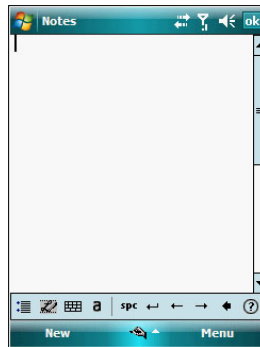

- 2 Write anywhere on the screen.
- 3 Pause and let transcriber change the written characters to typed text.

To learn how to write a letter in Transcriber:

- 1 Tap the **letter shape** icon  on the toolbar.
- 2 In the screen that appears, select the letter you want to learn about, then tap one of the examples.

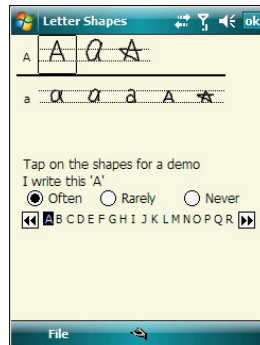

To punctuate in Transcriber:

- 1 Tap the **keyboard** icon  on the toolbar.
- 2 Tap the punctuation mark you need.

TIP: For specific instructions on using the Transcriber, tap the **question mark** on the toolbar.

Star Key

Use the Star Key option to enter special symbols not available on the regular soft keyboard, such as £ and £.

To enter special symbols:

- 1 Tap the **Input Selector**  arrow, then select **Star Key**.

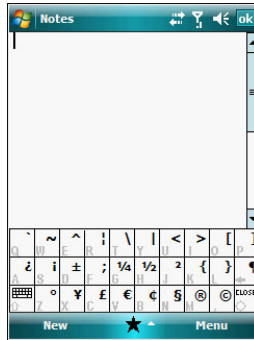

- 2 On the soft keyboard that is displayed, tap the special symbol keys with your stylus.

Writing on the screen

In Notes, you can use your stylus to write directly on the screen. Write the way you do on paper. You can edit and format what you've written and convert the information to text at a later time.

To write on the screen:

- Tap **Menu > Draw**.

This action displays lines on the screen to help you write.

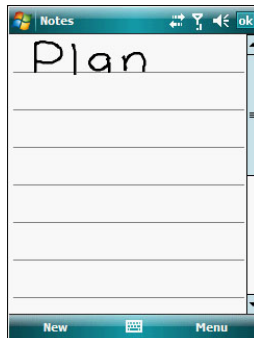

3 Entering Information

Drawing on the screen

To select and edit written text:

If you want to edit or format written text, you must select it first.

- 1 Tap and hold the stylus next to the text you want to select until the insertion point appears.

- 2 Without lifting, drag the stylus across the text you want to select.

If you accidentally write on the screen, tap **Menu > Undo Ink**, and try again.

-or-

Tap the text to deselect it.

- 3 You can cut, copy, and paste written text in the same way you work with typed text:

- (a) Tap and hold the selected words.
- (b) Tap an editing command on the pop-up menu.

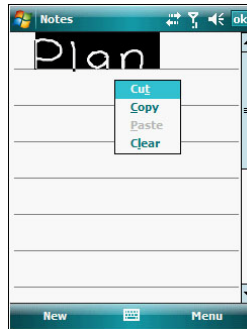

Drawing on the screen

In Notes, you can draw on the screen in the same way that you write on the screen. The difference between writing and drawing on the screen is how you select items and how they can be edited. For example, selected drawings can be resized, while writing cannot.

To create a drawing:

- 1 Draw a leaf on the screen.

A drawing box appears.

- 2 Subsequent strokes in or touching the drawing box become part of the drawing. Drawings that do not cross three ruled lines are treated as writing.

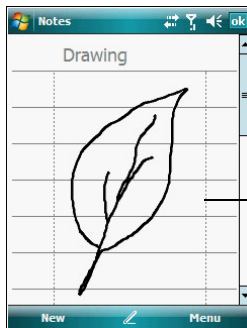

The drawing box indicates the boundaries of the drawing.

You may want to change the zoom level so that it is easier to work on or view your drawing. Tap **Menu > Zoom** and select a zoom level.

To select a drawing:

If you want to edit or format a drawing, you must select it first.

- Tap and hold the stylus on the drawing until the selection handle appears.
- To select multiple drawings, tap and hold the stylus on the drawing, then drag to select the drawings you want.

To edit a drawing:

- 1 Tap and hold the selected drawing.
- 2 Tap an editing command on the pop-up menu, or tap **Menu > Edit**.

Recording a message

In any program where you can write or draw on the screen, you can also quickly capture thoughts, reminders, and phone numbers by recording a message.

- In Calendar, Tasks, and Contacts, you can include a recording in an item.
- In Notes, you can either create a stand-alone recording, include a recording in a written note, or set a voice recording as your ring tone.
- In Phone, you can create a recording during a call.
- In Messaging, you can attach a recording to an e-mail message.



To create a recording in Notes:

- 1 Tap  > **Programs**  > **Notes** .

If you want to include the recording in a note, open the note first.

- 2 Tap **Menu > View Recording Toolbar**.
- 3 Position your device's built-in microphone near your mouth or other source of sound.

You can also use the microphone in the stereo headset/single earbud headset bundled with your device to create a recording.

- 4 On the Recording toolbar, tap .
- 5 Tap  to stop recording.
The new recording appears in the note list or as an embedded icon.

To play a recording:

- Tap it in the list or tap its icon in the Notes.

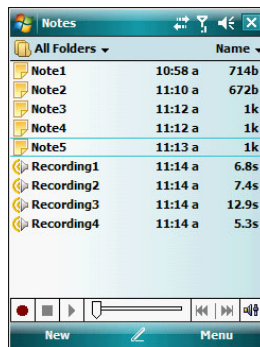

3 Entering Information

Using My Text

To set a voice recording as ringtone:

- Tap and hold a voice recording in Notes, then select **Set As Ringtone** on the pop-up menu.

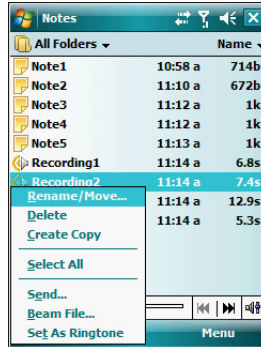

Using My Text

When using Messaging, use My Text to quickly insert preset messages into the text entry area.

To insert a My Text message:

- 1 Tap **Menu > My Text**, then tap a message.

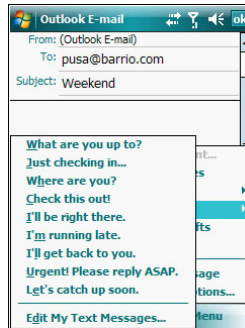
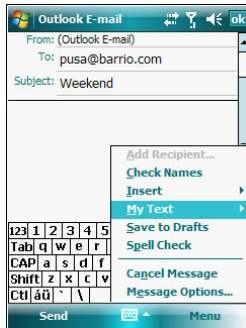

- 2 Tap **ok**.

Using ActiveSync

Use Microsoft ActiveSync to synchronize information between your MC35 and your computer and/or a server so you always have the most up-to-date information wherever you are.

Use ActiveSync to:

- Keep Microsoft Outlook Mobile data up-to-date by synchronizing your device with the Microsoft Outlook data on, including Outlook contacts' pictures, on your computer.

NOTE: Microsoft Outlook XP or Microsoft Outlook 2003 is required for synchronization of Outlook contacts' pictures.

- Open and edit your Microsoft Office Mobile files in your device and synchronize it back to your computer. Files are automatically converted to the correct format.
- Access and configure Microsoft Windows Media Player music, including album art, and video files on your computer.

IMPORTANT: Windows Media Player files can only be synchronized via ActiveSync USB connection.

- Synchronize Internet Explorer Mobile favorites on your computer.

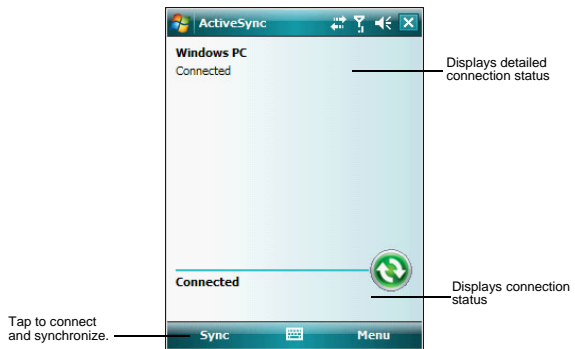

Synchronizing information with your computer

ActiveSync supports the following connection options between your device and your computer:

- USB connection – using the USB sync cable. This connection is established when you created your device's ActiveSync partnership with your computer.

IMPORTANT: Using an external USB hub when establishing an ActiveSync connection may result in some connection instabilities such as drops in the connection, or an unresponsive computer. For more information about this issue, see article 817900, "USB port may stop working after removing or inserting USB device" in the Microsoft Knowledge Base at <http://support.microsoft.com>.

- Infrared connection – This connection is only applicable if your computer has an infrared port. This method is ideal for quickly switching between multiple devices since there are no cables or adapters to change.
- Bluetooth connection – This connection is only applicable if your computer is equipped with a Bluetooth adapter or access point.

3 Entering Information



Using ActiveSync

NOTE: To synchronize remotely with your computer, it must be turned on.

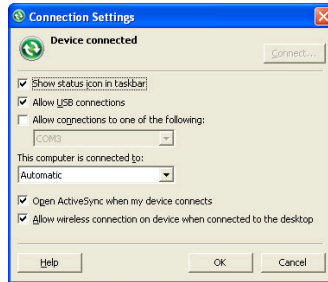

To set up a USB ActiveSync connection:

- 1 Perform the steps below on your computer.
 - (a) Open **ActiveSync** .
 - (b) Click **File > Connection Settings**.



- (c) Select the "Allow USB connections" option.
 - (d) Click **OK**.
 - 2 Perform the steps below on your device.
 - (a) Tap  > **Programs**  > **ActiveSync** .
 - (b) Tap **Menu > Connections**.
 - (c) Select the "Synchronize all PCs using this connection" option.
 - (d) Select **USB**.
 - (e) Tap **ok**.
 - 3 Connect your device to your computer using the USB sync cable.
Synchronization is automatically initiated.

To set up an infrared ActiveSync connection:

- 1 Perform the steps below on your computer.
 - (a) Configure the infrared port on your computer.
Refer to your computer's user documentation for instructions.
 - (b) Once your computer's IR port  is ready, open **ActiveSync** .
 - (c) Click **File > Connection Settings**.
 - (d) On the "Allow connections to one of the following" drop-down list, select **Infrared Port (IR)**.
 - (e) Click **OK**.

- 2 Perform the steps below on your device.
 - (a) Align the IR port  of your device with that on your computer so that they are unobstructed and within close range.

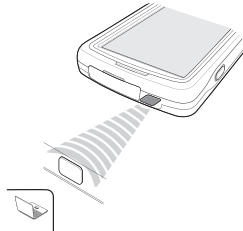

- (b) Tap  > **Programs**  > **ActiveSync** .
 - (c) Tap **Menu** > **Connect via IR**.

Synchronization is automatically initiated. Wait for synchronization to complete before you move your device.

To set up a Bluetooth ActiveSync connection:

Before setting up a Bluetooth ActiveSync connection, configure the Bluetooth function of your device. See “Bluetooth connection” on page 47 for more information.

IMPORTANT: For additional security, disable network bridging on the computer (specifically, bridging to a Remote NDIS adapter) before connecting to the computer to pass through to the Internet or a network. For more information on network bridging, see **Windows Help** on your computer.

NOTE: The instructions below are for computers that support the Windows XP SP2 or later version operating system.

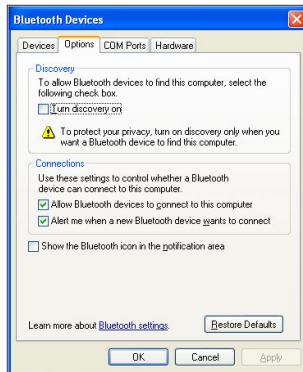

- 1 Perform the steps below on your computer.
 - (a) Click **Start > Settings > Control Panel**.
 - (b) Double-click **Bluetooth Devices**.
 - (c) On the **Options** tab, select the check box for the “Turn discovery on” and “Allow Bluetooth devices to connect to this computer” options.



3 Entering Information *Using ActiveSync*

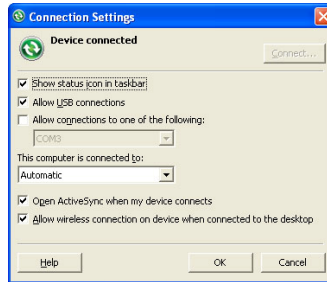

- (d) On the **COM Ports** tab, click **Add**.
- (e) Select the "Incoming (device initiates the connection)" option, then click **OK**.
- (f) Note the number of the COM port that was added. The COM port number must be no higher than 20.
- (g) Click **OK**.
- (h) Open **ActiveSync** .
- (i) Click **File > Connection Settings**.

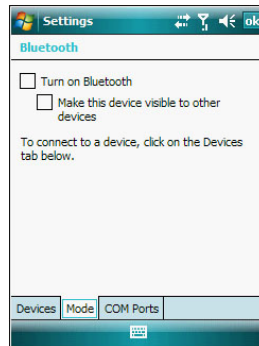

- (j) On the "Allow connections to one of the following" drop-down list, select the COM port with the number you noted in step f.
- 2 Ensure that the Bluetooth is turned on your computer and discoverable and within close range.
 - 3 Make MC35 discoverable to your PC.
- (a) Tap  > **Settings**  > **Connections tab > Bluetooth** .



- (b) On the Mode tab, select the check box for the "Turn on Bluetooth" and "Make this device visible to other devices" check box.
- (c) Tap **ok**.

- 4 Perform the steps below on your device.
 - (a) Tap  > **Programs**  > **ActiveSync** .
 - (b) Tap **Menu** > **Connect via Bluetooth**.

Synchronization is automatically initiated. The **PC to USB status** icon  appears on the lower right corner of the Today screen.

If an Authentication is required, the **Enter Passcode** screen appears, type an alphanumeric passkey (PIN code), then tap **Next**; enter the same passkey on the other device.

The passkey is recommended for enhanced security. Your passkey must be between 1 to 16 alphanumeric characters.

If you do not want to use a passkey, tap **Next**.

Synchronizing with a server



The option to synchronize your device with a server is available when you first create a partnership. Note that this option only synchronizes information for Contacts, Calendar, Messaging (Outlook E-mail), and Tasks.

After your first full synchronization with Microsoft Exchange server, you can schedule automatic synchronization between your device and the server every time an item arrives or is changed in the Microsoft Exchange server.

Enable server synchronization only if you are certain that your company is running Microsoft Exchange Server with Exchange ActiveSync. Before you can begin to synchronize information with a server, you need to request the following information, either from your service provider or from your corporate network administrator:

- Your user name and password in your corporate network
- The name of the Microsoft Exchange server

To set up synchronization with a Microsoft Exchange server:

- 1 Tap  > **Programs**  > **ActiveSync** .
- 2 Tap **Menu** > **Add Server Source**.

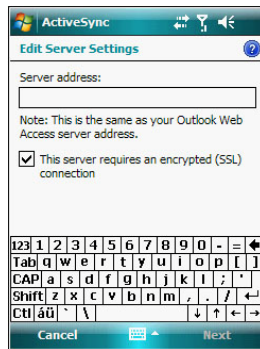

- 3 In the "Server address" box, enter the name of the Microsoft Exchange server to which you want to connect.

Select the "This server requires an encrypted (SSL) connection" option if it is applicable to your corporate network.

- 4 Tap **Next**.
- 5 Enter your user name, password, and domain name.



If you intend to enable automatic synchronization, select the "Save password" option.

3 Entering Information

Using ActiveSync

- 6 Tap **Advanced**.
Define the rules for resolving conflicts if items change on both your device and on the server.
- 7 Tap **Next**.
- 8 Select the check box opposite the types of information that you want to synchronize with the server.
- 9 Define the synchronization settings for each information type by tapping the type of information, then tap **Settings**.
- 10 Tap **Finish**.



To set up automatic synchronization with a server:

- 1 Tap  > **Programs**  > **ActiveSync** .
- 2 Tap **Menu** > **Schedule**.
- 3 Perform one or both of the following:
 - Under Peak times, select the "When new items arrive" option.
It is more cost-efficient to synchronize on a regular schedule when mail volume is high, instead of when new items arrive.
 - Under Off-peak times, select the "When new items arrive" option.
This can be more cost-efficient than synchronizing on a regular schedule when mail volume is low.
- 4 To set the days and hours that makes up your peak and off-peak times, click **Change Times**.
- 5 Tap **ok**.

NOTE: Some devices or versions of Microsoft Exchange Server may also require you to specify a device address to use this feature.

To stop synchronizing with a server:

You can stop synchronizing an information type with a server, and instead synchronize it with your computer.

- 1 Tap  > **Programs**  > **ActiveSync** .
- 2 Tap **Menu** > **Options**.

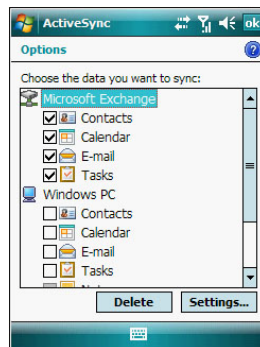

- 3 Deselect the check box opposite the types of Information that you no longer want to synchronize with the server.
- 4 Tap **ok**.

Using ActiveSync to copy files

You can use ActiveSync to exchange information from your device to your computer and vice versa. Changes you make to the information on one location do not affect the information on the other one. If you want to automatically update information on both your device and computer, synchronize the information instead.

You can copy two types of information to your device: files and Pocket Access Windows CE Store information.

The procedure below only applies to copying files. Refer to the ActiveSync Help on your computer for instructions on how to copy Pocket Access Windows CE Store information.

To copy files:

- 1 Connect your device to your computer.
- 2 In ActiveSync on your computer, click **Explore**.
Windows Explorer opens the Mobile Device window for your device.
- 3 Locate the file that you want to copy on your device or computer.
- 4 Perform one of the following:
 - To copy the file to your device, right-click the file and click **Copy**. Place the cursor in the desired folder for your device, right-click, then click **Paste**.
 - To copy the file to your computer, right-click the file and click **Copy**. Place the cursor in the desired folder for your computer, right-click, then click **Paste**.

Synchronization options

Users have the option to customize both the type and volume of information to be synchronized, as well the schedule synchronization should occur.



Remote synchronization schedule

You can control when remote synchronization occurs by selecting a synchronization schedule.

NOTE: When you are in roaming mode, you can synchronize manually to reduce roaming charges, or you can use the mobile schedule you've set.

NOTE: When your device is connected to your computer via the USB sync cable, synchronization occurs automatically—changes made on the computer or device is duplicated immediately.

To set up a wireless synchronization schedule:

- 1 Tap  > **Programs**  > **ActiveSync** .
- 2 Tap **Menu** > **Schedule**.
- 3 Perform one or both of the following:
 - Under **Peak times**, select a shorter interval when you are working or when e-mail volume is high.
 - Under **Off-peak times**, select a longer interval or the "As items arrive" option.
 - Enabling the "Use above settings when roaming" option is more consumptive in terms of battery power and roaming cost compare to manual synchronization.
- 4 Tap **ok**.

3 Entering Information

Using wireless communication

Synchronization type and volume

By default, ActiveSync only synchronize information for Contacts, Calendar, Messaging (Outlook E-Mail), Tasks, and Favorites (for Internet Explorer Mobile). You can select which information types are synchronized. You can also control how much information is synchronized. To illustrate, when synchronizing Calendar, you can set ActiveSync to synchronize appointments within a certain date range and for specific categories only. For example business appointments from the past two weeks only.

To control the volume of information synchronized, see the "Synchronizing ..." section "Using the Windows Mobile Programs" on page 65.

NOTE: ActiveSync does not support synchronizing subfolders in Calendar and Contacts.

To select the type of information to synchronize:

IMPORTANT: If you decide to synchronize files, for example Word documents, ActiveSync needs to convert these files. Converted files may not contain all information found in original file.

- 1 Connect your device to your computer.
- 2 Click **Tools > Options**.
- 3 Select the information type that you want to synchronize.
- 4 If available, click **Settings**, and then select the options you want.
- 5 Repeat steps 2 and 3 for each information type.

ActiveSync errors

Whenever ActiveSync cannot successfully synchronize information, it displays an Error link on the ActiveSync window on your device. Tap the link to display more information about the error that occurred.

Some types of errors can interfere with automatic synchronization. If you suspect that a scheduled automatic synchronization has not occurred, you should try to manually synchronize your information. Successfully completing manual synchronization resets automatic synchronization.

Using wireless communication

You can use any of the wireless communication options listed below to download information to your MC35. For more information on using these options, See "5 Wireless Communications" on page 45 for more information.

- IR port for short-range file exchange
- Bluetooth for PAN connection
- High-speed GPRS for mobile Internet access
- Optional Wi-Fi (IEEE 802.11b/g) for WLAN connection



4 Managing Information

- Opening programs
- Using Search
- Using File Explorer

Opening programs

Your MC35 supports a variety of EDA and wireless communication programs to help you manage both personal and work-related information.

To open a program:

- Tap a program name from the  menu.
You can select which programs are displayed on the  menu. See "To add a program to the Start menu program using Settings" on page 236 for more information.

NOTE: Some programs have abbreviated labels for check boxes and drop-down lists. To see the full spelling of an abbreviated label, tap and hold the stylus on the label. Drag the stylus off the label so that the command is not carried out.

- Tap  > **Programs** , then tap program icon.

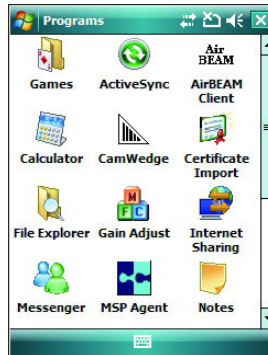















4 Managing Information















Opening programs

Program list

The following table contains a list of programs installed on your device.



NOTE: To get detailed information on using any of the applications listed in this section, open the program, tap  > **Help** .

Icon	Program	Usage
	Calculator	Perform basic arithmetic computations.
Device management programs		
	ActiveSync	Synchronize information between your device and your computer and/or server.
	File Explorer	Manage the files stored on your device, as well as those in a storage card.
	Search	Locate specific files stored on your device, as well as those in a storage card.
Microsoft Outlook Mobile programs		
	Calendar	Keep track of your appointments and create meeting requests.
	Contacts	Keep track of your friends and colleagues.
	Messaging	Send and receive text and e-mail messages.
	Notes	Create handwritten or typed notes, drawings, and voice recordings.
	Tasks	Keep track of your tasks.
Microsoft Office Mobile programs		
	Excel Mobile	Create new workbooks or view and edit Excel workbooks created on your computer.
	PowerPoint Mobile	View slide show presentations.
	Word Mobile	Create new documents or view and edit Word documents created on your computer.
Other Microsoft Windows Mobile programs		
	Internet Explorer Mobile	Browse Internet and intranet sites, and download programs and files to your device.
	Messenger	Send and receive instant messages or voice messages, join multiparty chats, send and receive files, including personal photos.

Icon	Program	Usage
	Windows Live	Subscribe to popular Windows Live services, including Live Mail, Live Messenger, Live Search, and Live Sync.
	Windows Media Player Mobile	Play stored or streaming digital audio and video files.
Phone-related programs		
	Phone	Send and receive local and international calls and text messages.
	Gain Adjust	Adjust the Bluetooth headset's earphone and microphone signal level to reduce unwanted background noise and improve audio quality.
	SIM Manager	View the contents of your SIM card and transfer it to your contacts list.
	SIM Toolkit	Access the mobile content and data services, such as news, weather, banking, and traveling information; offered by the mobile phone service provider.
Wireless communication programs		
	Express GPS Connect	Use Assisted Global Positioning System (AGPS) technology for your travel/navigation activities.
	Internet Sharing	Configure your device as a modem for connecting to the Internet via a USB or Bluetooth personal area network (PAN) connection.
	Push to Talk	Conduct walkie-talkie style conversations using a mobile phone connection.
	Remote Desktop Mobile	Log onto a Windows NT server type PC and use all of the programs that are available on that PC from your device.
Media-related programs		
	CamWedge	Enable bar code data capture.
	Pictures & Videos	Take pictures and video.
Download-related programs		
	AirBEAM Smart Client	Allows specially designed software packages to be transferred between a host server and your device.
	Certificate Import	Imports digital certificates to protect data on your device or establish secure network connections.



4 Managing Information

Using Search

Icon	Program	Usage
	MSP Agent	Interacts with SMP agents to collect monitoring and asset information to enable the configuration, provisioning, monitoring, and troubleshooting of your device.
	Rapid Deployment Client Version	Facilitates software downloads from a Mobility Services Platform Console FTP server to your device.

Using Search

The Search function helps you locate a particular file quickly.

- 1 Tap  > **Programs**  > **Search** .
- 2 Enter the file name of the file you're searching, then select a data type.
- 3 Tap **Search**.

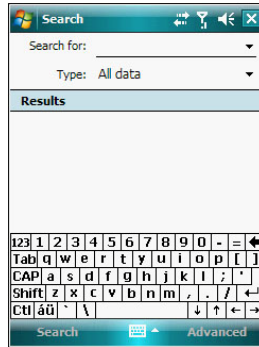



Using File Explorer

Use File Explorer to locate files on your device and to organize these files into folders.

- Tap > Programs > File Explorer .

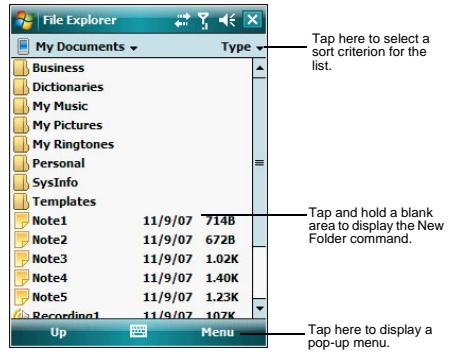

5 Wireless Communications

- Wireless communication features
- Managing wireless connections
- Getting connected

Wireless communication features

You can use your MC35 to exchange information with other mobile devices and connect to your computer, a network, or the Internet. You have the following connection options:

- Use the infrared sensor or the Bluetooth function to exchange files from another IR- or Bluetooth-enabled device.
- Use a GPRS or Wi-Fi connection to send and receive e-mail messages by using Messaging; and view Web or WAP pages by using Internet Explorer Mobile. Contact your mobile phone service provider to have your WAP or GPRS connection activated.



Beam function

In a Microsoft Windows Mobile program (except Messaging), and Picture & Videos, you can exchange files using either infrared or Bluetooth.

TIP: You can also beam files (not folders) from the File Explorer screen. To do, tap and hold the item you want to send, then tap Beam File from the pop-up menu.

First activate the beam function before exchanging files with another IR- or Bluetooth-enabled device.

To activate the Beam function:

- 1 Tap  > **Settings** .
- 2 On the Connections tab, tap **Beam** .
- 3 Tap "Receive all incoming beams" check box.

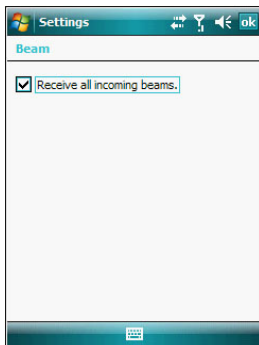

- 4 Tap **ok**.

5 Wireless Communications

Wireless communication features

Infrared connection

Using infrared, you can enable short-range file exchange between your MC35 and another IR-enabled device.

Exchanging files using IR connection

Ensure that the IR function on both your MC35 and on other device you want to exchange files with are enabled.

To send files via IR connection:

- 1 Switch to the program where you created the item you want to send and locate the item in the list.
- 2 Align the IR port  of your device with that of the IR-enabled device so that they are unobstructed and within a close range.

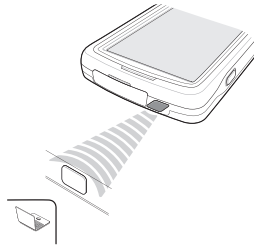

- 3 Tap and hold the item, then tap **Beam [type of item]** on the pop-up menu.
- 4 Tap the device that you want to send the file to.

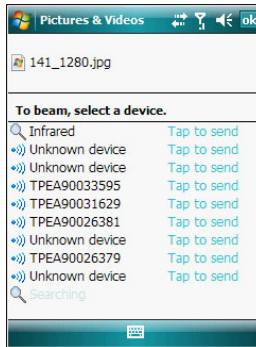

To receive files via IR connection:

- 1 Align the IR port  of your device with that of the IR-enabled device so that they are unobstructed and within a close range.
- 2 Have the owner of the other IR-enabled device send the file to you.

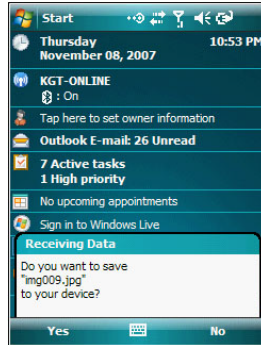

- 3 On the Receiving Data callout, tap **Yes**.

Bluetooth connection

Your device allows you to connect to any Bluetooth-enabled device in your personal area network (PAN). Once connected you can perform the following:

- Send and receive files to another Bluetooth-enabled device.
- Transfer an outgoing call to a Bluetooth-enabled headset. See "To make a call from a Bluetooth-enabled headset" on page 109 for more information.
- Print files to a Bluetooth-enabled printer.
Additional software is required on your device to enable you to print files to a Bluetooth-enabled printer. Contact your local dealer for more information.
- Once connected to another Bluetooth-enabled device or computer, you can locate and use any of the services available on the device.



Activating the Bluetooth function

You have two options to activate your MC35's Bluetooth connection—using the Wireless Manager or the Bluetooth option under the Settings > Connections preferences. Once activated,  connection is indicated as **On** in the Wireless Manager section of the Today screen.

To activate Bluetooth via the Wireless Manager:

See "To activate Bluetooth via the Wireless Manager" on page 58 for more information.

To activate Bluetooth using the Settings option:

- 1 Tap  > **Settings** .
- 2 On the Connections tab, tap **Bluetooth** .

5 Wireless Communications

Wireless communication features

- 3 On the Mode tab, select all the check boxes.

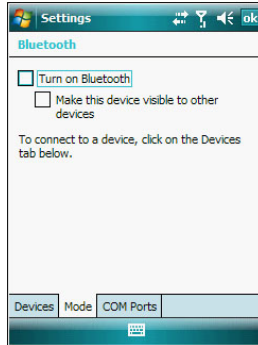

- 4 Tap **ok**.

NOTE: Deactivate the Bluetooth feature when you do not plan to use it for an extended time.

Creating a Bluetooth partnership

You need to create a partnership with another Bluetooth-enabled device to be able to exchange information with it.

To create a Bluetooth partnership:

- 1 Ensure that your MC35 and the other Bluetooth-enabled device(s) are turned on, visible, and within close range of each other.
- 2 Perform either of the following.
 - On the Wireless Manager screen, tap **Menu > Bluetooth Settings**.
 - Tap **Windows > Settings > Connections tab > Bluetooth**.
- 3 On the Devices tab, tap **Add new device**.

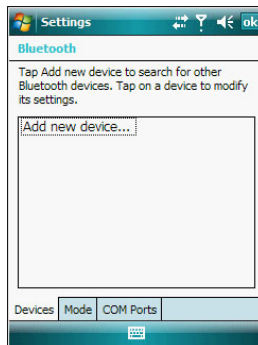

Your device searches for Bluetooth-enabled devices on your personal area network (PAN) and displays them in the device list.

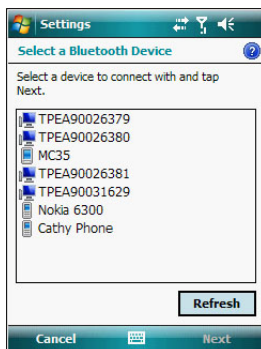

- 4 Tap the name of the device in the list, then tap **Next**.
If you want to use a passcode, type an alphanumeric passkey, then tap **Next**; enter the same passkey on the other device.
The passkey is recommended for enhanced security. Your passkey must be between 1 to 16 alphanumeric characters.
If you do not want to use a passkey, tap **Next**.
- 5 On the Partnership Settings screen, perform the following:

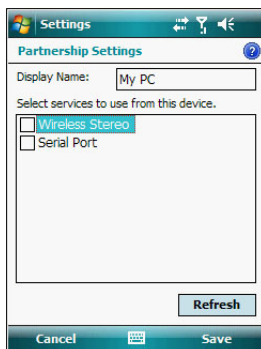

- (a) Type in a meaningful device name on the **Display Name** box to identify the device later.
 - (b) Select the type of services you want to enable for this Bluetooth partnership.
- 6 Tap **Finish**.

5 Wireless Communications

Wireless communication features

- 7 On the Bluetooth screen, tap the **COM Ports** tab, then tap **New Outgoing Port**.

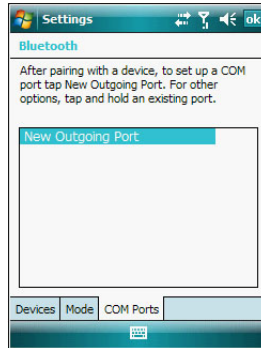

- 8 Select the device you want to add, then tap **Next**.
9 Select a numbered COM port from the list.
10 Select "Secure Connection" option to designate the COM port for Bluetooth partnership.
11 Tap **Finish**, then tap **ok**.

Exchanging files using Bluetooth

IMPORTANT: Ensure that the two devices have Bluetooth turned on, discoverable, and within close range.

To send files via Bluetooth:

- 1 Switch to the program where you created the item you want to send and locate the item in the list.
- 2 Tap and hold the item, then tap **Beam [type of item]** on the pop-up menu.
- 3 Tap the device that you want to send the file to.

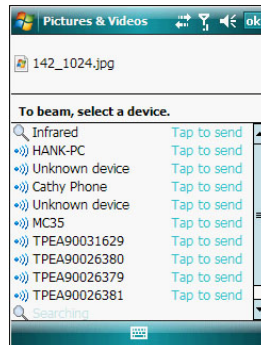

To receive files via Bluetooth:

- 1 Have the owner of the other Bluetooth-enable device send the file to you.



- 2 On the Bluetooth callout, tap **Yes**.

GPRS connection

General Packet Radio Service (GPRS) is a packet-switched technology that allows transmission of data between mobile phones and the Internet over a GSM network. It supports an "always on" capability which uses the GSM network only during data transmission. This means users only pay for the amount of downloaded information rather than the duration of the network connection.

The communication software for creating a GPRS connection is already installed on your device. Your service provider will provide software needed to install other services, such as paging and fax services.

Once you've established a GPRS connection, you can:

- Use Messaging to send and receive e-mail messages.
- Use Internet Explorer Mobile to access Web or WAP pages
- Use Windows Media Player 10 Mobile for Pocket PC to listen to streaming media
- Use Live Messenger to conduct IM sessions with your friends and colleagues.

Configuring your GPRS connection

To manually configure GPRS connection:

See "To connect to the Internet" on page 60 for more information.

For more information on configuring your device's GPRS setting, contact your mobile phone service provider.

Connecting to the GPRS network

NOTE: When downloading large files through GPRS data connection, incoming phone calls are not received. Phone calls are directed to voicemail.

A GPRS connection is required to connect to a GPRS network. To create a GPRS connection, the GPRS features on your GSM account must be enabled and activated on your SIM card. You may be required to configure your GPRS connection and authenticate GPRS to connect to the GPRS network. Obtain the user name and password from your mobile phone service provider.

To connect to GPRS network:



- 1 On the navigation bar, tap the **Data connectivity** icon .

5 Wireless Communications

Wireless communication features

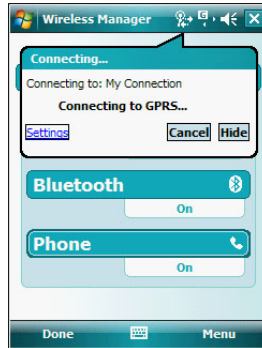
2 Tap **Connect GPRS**.



The Connecting call drop-down box displays. The GPRS data connection active icon  appears on the navigation bar and changes to  and to  once a GPRS connection is established.

To end a GPRS connection:

Perform one of the following:

- On the navigation bar, tap the **Data connectivity** icon , then tap **Cancel** on the Connectivity drop-down box.
- On the Today screen, tap **Wireless Manager**  > **Menu** > **Disconnect Cellular Data**.

Wi-Fi connection

Your MC35 supports an optional Wi-Fi hardware (IEEE 802.11b/g) you can use to scan for existing wireless local area network (WLAN) access points or hot spots. WLAN access points or hot spots can be found in homes and office or public areas such as inside airports, restaurants, coffee shops, hotels, or other public areas. Just like in a GPRS connection, a Wi-Fi access allows you to connect to a computer, access the Internet, and send/ receive e-mail and files.

NOTE: Wi-Fi access in some areas may require a separate purchase of a service contract with a wireless service provider. Check with a Wi-Fi service provider in your area for more information.

Activating a Wi-Fi connection

You have several options to activate your MC35's Wi-Fi connection—from the Today screen using the **Wireless Manager** or the **Wi-Fi** option under the **Settings** > **Connections** preferences. Once activated, Wi-Fi connection is indicated as **On** in the **Wireless Manager** section of the Today screen.

To activate Wi-Fi connection via the Wireless Manager:

See "To activate Wi-Fi connection via the **Wireless Manager**" on page 59 for more information.



Setting up a wireless network connection

After activating Wi-Fi connection, you can proceed to the wireless network setup. A wireless network can be automatically detected or be manually added by entering the related network settings. Before performing the procedure in this section, determine if authentication information is needed.

Check the following before setting up a wireless network connection for your device.

- Make sure that the Internet Protocol (TCP/IP) is installed on your computer.
- Make sure the network system and remote access server in your workplace supports TCP/IP protocol
- Make sure you have remote access account. Ask your network administrator for assistance on setting up a wireless connection.

To set up a wireless network connection:

- 1 Enable the device's wireless networking function. See "To activate Wi-Fi connection via the Wireless Manager" on page 59 for more information.
- 2 Tap  > **Settings** .
- 3 On the Connections tab, tap **Wi-Fi** .

TIP: Alternatively, from the Today screen, you can tap **Wireless Manager > Menu > Wi-Fi Settings**.

- 4 On the Wireless tab, perform one of the following:

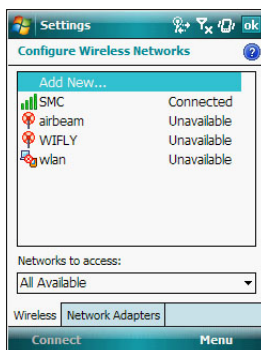

- If your preferred network is not listed, tap **Add New**. See "To add a wireless network " on page 55 for more information.
 - Tap an available wireless network. Previously configured networks are already listed. To change network settings, tap a network and follow the on-screen instructions.
- 5 In the Networks to access drop-down list, select the type of network you wish to connect to. Options include:
 - All available
 - Only access points
 - Only computer-to-computer
 - 6 Tap **ok**.

5 Wireless Communications

Wireless communication features

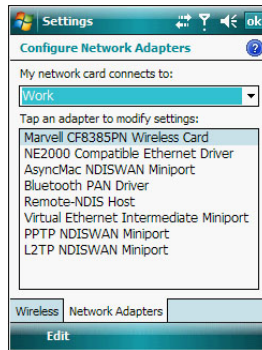

To configure a network adapter:

- 1 On the Wi-Fi screen, tap the **Network Adapters** tab.



- 2 Make your desired changes to the available adapters on the list.
- 3 Tap **ok**.

To connect to a wireless network:

- 1 Tap  > **Settings** .
- 2 On the Connections tab, tap **Wi-Fi** .
- 3 On the Wireless tab, tap an available wireless network.
- 4 On the command bar, tap **Connect**.

If a wireless network is detected, a similar screen appears, tap **Connect** on the command bar.

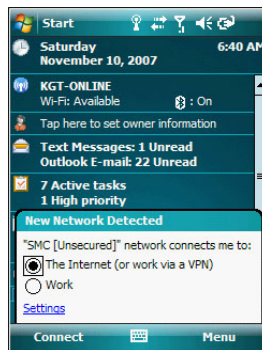

5 Wireless Communications

Wireless communication features

To add a wireless network:

If your preferred wireless network is not automatically detected, you can add the network provided you know the wireless network settings. Contact your network administrator for wireless network settings applicable to your network.

1 Open the Configure Wireless Networks screen by performing one of the following:

- Tap  > **Wireless Manager**  > **Menu** > **Wi-Fi Settings**.
- Tap  > **Settings**  > **Connections** tab > **Wi-Fi** .

2 On the Wireless tab, tap **Add New**.

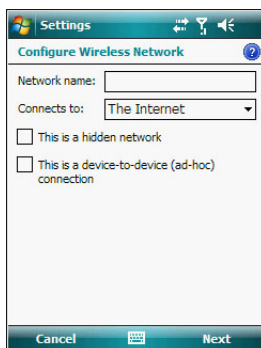

3 Enter the Network name, then choose whether the wireless network connects to The Internet or Work network.

4 If you want to connect to another wireless device (Ad-hoc mode), select the "This is a device-to-device (ad-hoc) connection" option.

5 Tap **Next**.

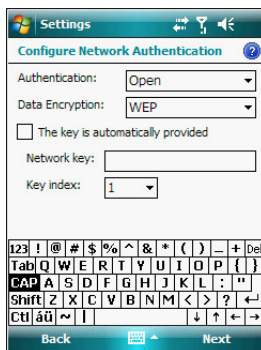

6 In the Authentication drop-down list, select the authentication method.

7 In the Data Encryption drop-down list, select an encryption method.

8 Tap "The key is automatically provided" check box or enter the network key.

NOTE: Obtain network security settings from the network administrator.

5 Wireless Communications

Wireless communication features

- 9 Tap **Next**.

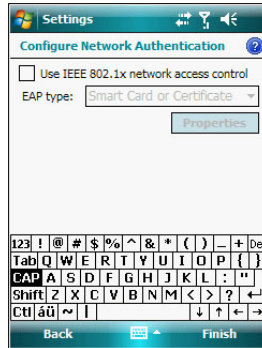

- 10 Tap the "Use IEEE 802.1x network access control" check box.
- 11 In the **EAP type** drop-down list, select an appropriate EAP method.
- 12 Tap **Finish**.

To set Wi-Fi region code:

- 1 On the **Wireless Manager** screen, tap **Menu > Wi-Fi Region Code Setting**.

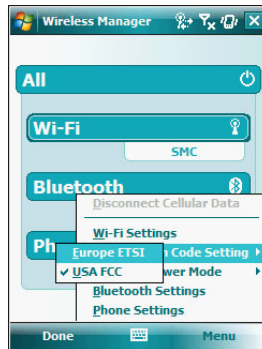

- 2 Select the region code applicable to your country.
- 3 Tap **Done**.

To set Wi-Fi performance mode:

- 1 Disable Wi-Fi connection on the [Wireless Manager](#) screen.
- 2 Tap **Menu > Wireless Power Mode**.

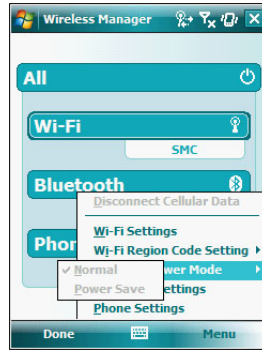

- 3 Select a running mode, then tap **Done**.







Managing wireless connections

Using Wireless Manager

The Wireless Manager provides easy management to the wireless features on your device. This program complements your device's integrated wireless card enabling you to turn the wireless features on and off and allows for centralized management of the Wi-Fi, Bluetooth, and Phone settings.

To open Wireless Manager:

Perform one of the following:

- On the [Today](#) screen, tap **Wireless Manager** .
- On the [navigation](#) bar, tap the **Data connectivity** icon  or **signal** icon , then from the Connectivity drop-down box, tap **Wireless Manager**.
- Tap  > **Settings**  > **Connections** tab > **Wireless Manager** .

Activating wireless features

You can use Wireless Manager to turn the following wireless features on and off— one at a time or all at the same time.

- Wi-Fi
- Bluetooth
- Phone
- Cellular Data GPRS connection

5 Wireless Communications

Managing wireless connections

To **turn multiple wireless features on:**

- On the **Wireless Manager** screen, tap **All > Done**.

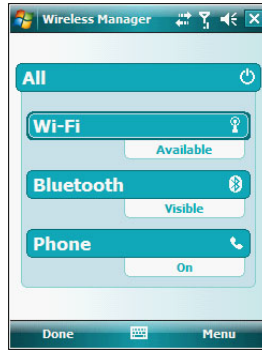

To **activate Bluetooth via the Wireless Manager:**

- On the **Today** screen, tap **Wireless Manager** .

Tap to launch the
Wireless Manager.

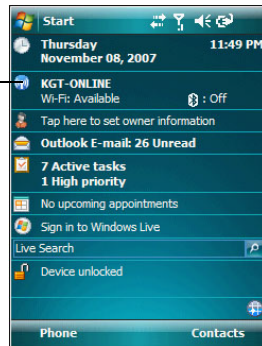

- On the **Wireless Manager** screen, tap **Bluetooth**.

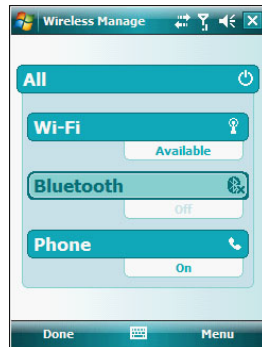

- 3 Tap **Done**.

To activate Wi-Fi connection via the Wireless Manager:

- 1 On the **Today** screen, tap **Wireless Manager** .
- 2 Tap **Wi-Fi > Done**.

To activate Phone via the Wireless Manager:

- 1 On the **Today** screen, tap **Wireless Manager** .
- 2 Tap **Phone > Done**.

To disconnect cellular data GPRS connection via the Wireless Manager:

- 1 On the **Today** screen, tap **Wireless Manager** .
- 2 Tap **Menu > Disconnect Cellular Data**.

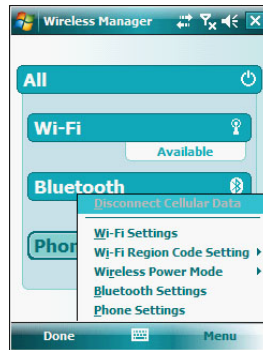

- 3 Tap **Done**.

Configuring the multiple wireless settings

Using Wireless Manager, you can set Phone, Bluetooth, and Wi-Fi settings.

To configure the Phone settings:

- 1 On the **Wireless Manager** screen, tap **Menu**.
- 2 Select **Phone Settings**.

The **Phone Settings** screen has five tabs—Phone, Services, Network, Band, and PPP Auth. See “Phone preferences” on page 109 for the configuration options available for each tab.

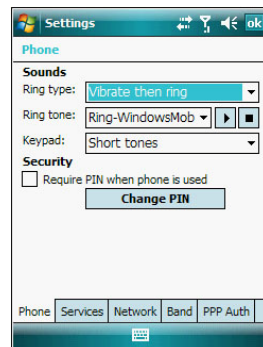

5 Wireless Communications

Getting connected

To configure the Bluetooth settings:

See "Bluetooth connection" on page 47 for more information.

To configure the Wi-Fi settings:

See "Wi-Fi connection" on page 52 for more information.

For information on configuring the Bluetooth settings, Phone settings, or Wi-Fi settings, tap **Help** ?.

Getting connected

After configuring your device's wireless settings you can now define the network settings you'll be using to access the Internet, connect to your office network, and view intranet URLs.

For help information on performing the following procedures, tap **Help** ? from the screen you're having difficulty with.

Once you've establish these network settings; use Internet Explorer Mobile to view Internet and intranet sites. See "Internet Explorer Mobile" on page 98 for more information.

Connecting to the Internet

You can connect to the Internet by using a modem or wireless connection. Before you perform the procedure below, obtain the following information from your Internet service provider (ISP) or wireless service provider.

- ISP server phone number or access point
- User name and password

To connect to the Internet:

- 1 Tap  > **Settings** .
- 2 On the Connections tab, tap **Connections** .
- 3 On the Tasks tab, tap **Add a new modem connection** from either My ISP or My Work Network.



- 4 Enter a name for the connection (e.g. Internet).
- 5 In the Select a modem list, select your modem type.
If you will be using a mobile phone network, select **Cellular Line**.
If you will be using GPRS, select **Cellular Line (GPRS)**.
- 6 Tap **Next**.
- 7 Enter the number to be dialed or the access point name provided by your mobile service provider.
- 8 Tap **Next**.

- 9 If required, enter the user name, password, and domain name.
If the mobile phone service provider specified the IP addresses of your DNS servers, tap **Advanced > Servers** tab. Select **Use specific server address**, enter the DNS addresses, then tap **ok**.
- 10 Tap **Finish**.
The connection is automatically started when you begin using a program that uses an Internet connection.
To manually start the connection, perform one of the following:
 - Repeat steps 1 and 2, then on the **Tasks** tab, tap **Manage existing connections** under **My ISP**. Tap and hold a connection name, then select **Connect** from the pop-up menu.
 - Perform the "To connect to a wireless network" procedure on page 54.

Flight Mode

Flight Mode allows you to turn off all the active wireless connections for safe use on an airplane.

To turn off wireless connections:

- 1 Press and hold the **End**  button for five seconds.

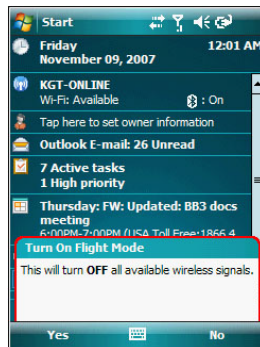

- 2 Select **Yes** when the Turn On Flight Mode notification appears. All active wireless connections are turned off.

When you want to turn the wireless connections back on, press and hold the **End**  button for five seconds. Select **Yes** when the Turn Off Flight Mode notification appears. The device remembers which wireless connections were active prior to entering Flight Mode and only turns on those wireless connections.

Connecting to your office network

You can connect to your office network by using a modem, virtual private network (VPN), or wireless connection. Before you perform the procedure below, obtain the following information from your network administrator or your wireless service provider.



- For a modem connection:
 - ISP server phone number or access point
 - User name and password
- For a VPN connection:
 - User name, password, and domain name
 - TCP/IP settings
 - VPN server host name or IP address
 - ISP server phone number or access point

If you will be using a modem or a VPN connection, perform the procedure in this section. If you will be using a wireless connection, perform the "To connect to a wireless network" procedure on page 54.

5 Wireless Communications

Getting connected

To connect to your office network:

- 1 Tap  > **Settings** .
- 2 On the Connections tab, tap **Connections** .
- 3 Under My Work Network on the Tasks tab; select the kind of work connection you will be using.
- 4 Enter the required information for the selected work connection.
- 5 Tap **Finish**.



The connection is automatically started when you use Internet Explorer Mobile to connect to your work network. Begin using a program that uses an Internet connection. To manually start the connection, perform one of the following:

- (a) Repeat steps 1 and 2, then on the Tasks tab, tap **Set up my proxy server** under My Work Network.
- (b) On the Modem or VPN tab, tap and hold a connection name, then select **Connect** from the pop-up menu.

Viewing intranet URLs

If you'll be connecting to intranet sites that have periods in their URLs (e.g. intranet.corporatename.com), you must add them to the Work URL Exceptions list. Otherwise, Internet Explorer Mobile will search for them in the Internet rather than the company's intranet.

To add an intranet URL:

- 1 Tap  > **Settings** .
- 2 On the Connections tab, tap **Connections** .
- 3 On the Advanced tab, tap **Exceptions**.

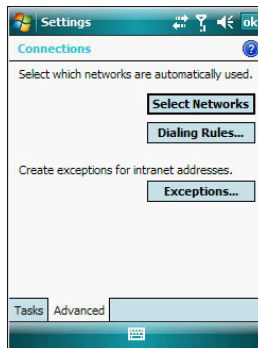

- 4 Tap **Add New URL**.
- 5 Enter the intranet URL.

TIP: If you use URLs that share the same root company name, you can add them as group by entering ***.corporatename.com**.

- 6 Tap **ok**.



Setting an e-mail server connection



You can set up a connection to an e-mail server so that you can send and receive e-mail messages on your device. You can use multiple e-mail accounts to receive your messages. For each e-mail account you intend to use, first set up and name the e-mail service. If you use the same service to connect to different mailboxes, set up and name each mailbox connection.

There are two types of e-mail account that can be managed using your device.

- Microsoft Outlook
Using Microsoft Outlook, your Inbox is updated each time you sync with your computer or corporate e-mail server.
- POP3/IMAP4
This includes e-mail service from providers. These e-mail accounts can be managed remotely using a wireless connection.

To set up an e-mail account:

For an explanation on any of the setup screens, tap  > **Help** .

1 Tap  > **Messaging** .

2 Tap **New E-mail Account**.

3 Enter your e-mail address.

4 Tap the "Try to get e-mail settings automatically from the Internet" check box to allow auto setup to connect to the Internet and obtain e-mail server settings.

5 Tap **Read Privacy Statement online** to address privacy concerns.

6 Tap **Next**.

This will initiate auto setup which attempts to connect your device to your e-mail server and automatically download the necessary e-mail connection settings. If auto-configuration is successful you can begin sending/receiving e-mails. If unsuccessful you will need to manually enter the settings.

7 Once auto setup is finished, tap **Next**.

8 Enter your name and the name you want displayed when you send an e-mail.

9 Tap **Next**.

If auto setup is not successful, contact your ISP or network administrator for the following information and enter them manually:

- User name and password
- Domain name
- Account type and name
- Incoming and outgoing e-mail server

6 Using the Windows Mobile Programs

- Microsoft Outlook Mobile programs
- Microsoft Office Mobile programs
- Windows Media Player 10 Mobile for Pocket PC
- Internet Explorer Mobile
- Windows Live Mobile

Microsoft Outlook Mobile programs



Microsoft Outlook Mobile includes Calendar, Contacts, Tasks, Notes, and Messaging. You can use these programs individually or in tandem with each other. For example, e-mail addresses stored in Contacts can be used in Messaging.

You can use ActiveSync to synchronize your Outlook Mobile data with the Microsoft Outlook information on your computer or to a Microsoft Exchange server. See "Using ActiveSync" on page 31 for more information.

Calendar

Calendar enables you to conveniently manage your schedules and appointments or any other activities associated with a time and date. You can schedule appointments, including meetings and other events. Checking your appointments is easy using one of several views—Agenda, Day, Week, Month, and Year.

To open Calendar:

- Tap  > **Calendar** .
- Calendar opens to today's schedule.

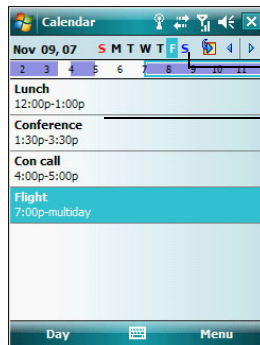

Tap to go to current date.

Tap to display or edit the appointment details.

Switch display views by tapping the view option on the lower left corner of the command bar.

NOTE: You can customize the Calendar display, such as changing the first day of the week, by tapping **Menu > Tools > Options**.

6 Using the Windows Mobile Programs

Microsoft Outlook Mobile programs

Scheduling an appointment

- 1 If you are in **Day** or **Week** view, tap the desired date and time for the appointment.
- 2 Tap **Menu > New Appointment**.

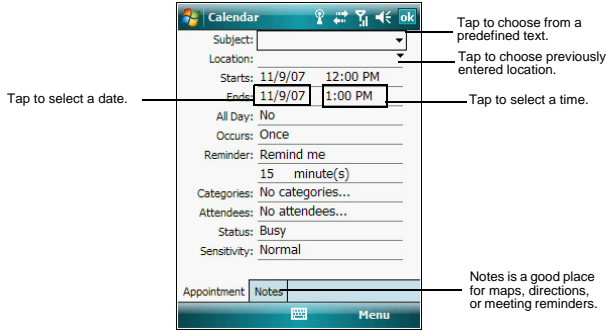

- 3 Using the soft keyboard, enter the appointment details.
To select a field, tap it.
Hide the soft keyboard to see all available fields.
- 4 To add notes, tap the **Notes** tab.
- 5 After completing the appointment details, tap **ok**.

If you select "Remind me" in an appointment, your device notifies you according to the options set in the **Settings > Personal > Sounds & Notifications** option.

Viewing an appointment

You can view an appointment schedule in all views except for Year and Agenda view.

- To see the details of an appointment, tap the appointment.
- To see a pop-up menu of available actions for an appointment, tap and hold the appointment.
- In Year view, the time of appointments are indicated by symbols. An upward triangle means a morning appointment; a downward triangle means an afternoon appointment. A solid square indicates an appointment that overlaps the noon day border.

Finding an appointment

- Tap **Windows Mobile > Programs > Search**, enter the appointment name, select **Calendar** for the type, then tap **Search**.

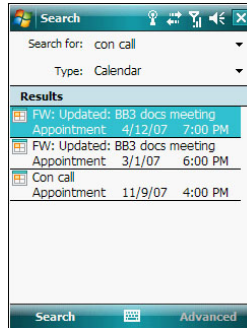

Beaming an appointment

You can send an appointment to another IR- or Bluetooth-enabled device by beaming it.

- 1 If you intend to send the appointment:
 - Via **IR**: Ensure that the two devices have IR turned on, then align the IR port  of your device with that of the other device so that they are unobstructed and within close range.
 - Via **Bluetooth**: Ensure that the two devices have Bluetooth turned on, discoverable, and within close range.
- 2 In **Agenda**, **Day** or **Month** view, tap and hold the appointment.
- 3 Select **Beam Appointment** on the pop-up menu.
- 4 Tap the device that you want to send the appointment to.

Using the Calendar summary screen

When you tap an appointment in Agenda or Day view, a summary screen is displayed. To change the appointment, tap **Edit**.



Creating a meeting request

You can use Calendar to set up meetings with users of Outlook or Pocket Outlook. The meeting request is created automatically and is sent when you synchronize Messaging or when you connect to your e-mail server. Indicate how you want meeting requests sent by tapping **Menu > Options**.

To schedule a meeting:

- 1 Create an appointment.
- 2 In the appointment details, hide the input panel, then tap **Attendees**.
- 3 Tap **Add Required Attendee**.
- 4 Select a contact from the Contact list.
- 5 Tap **Done** to return to the appointment details page.
- 6 Tap **ok**.

The meeting request is created automatically and placed in the Outlook E-mail Outbox folder.
- 7 Tap **ok**.

Synchronizing calendar items

- Calendar items created on your device are copied to your computer and/or on a Microsoft Exchange server during synchronization, and vice versa. By default, Calendar items from the last two weeks are synchronized.
- Similarly, Calendar items that are deleted from your device are deleted from your computer and/or server during synchronization, and vice versa.

6 Using the Windows Mobile Programs

Microsoft Outlook Mobile programs



- To save storage space on your device, synchronize appointments within a convenient date range. Perform the following:
 - (a) Connect your device to your computer.
 - (b) In ActiveSync on your computer, if the details pane is not open, click **Show Details**.
 - (c) Double-click **Calendar**, then select an interval in "Synchronize only the past".

Contacts

Contacts maintains a list of your friends' and colleagues' contact information.

To open Contacts:

Perform one of the following:

- On the **Today** screen, press the **right soft** button or tap **Contacts** .
- Tap  > **Contacts** .
Contacts opens to the contact list. To change the way contact information is displayed in the list, tap **Menu** > **Options**.

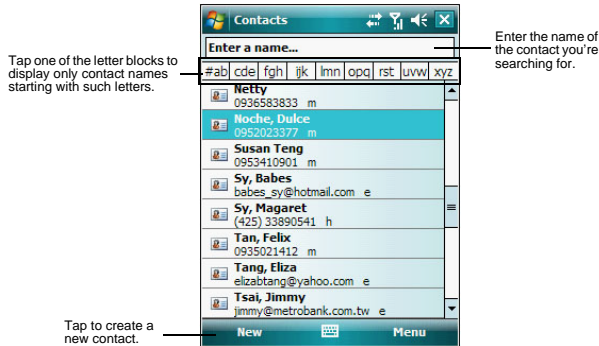

To create a contact:

- 1 Tap **New**.

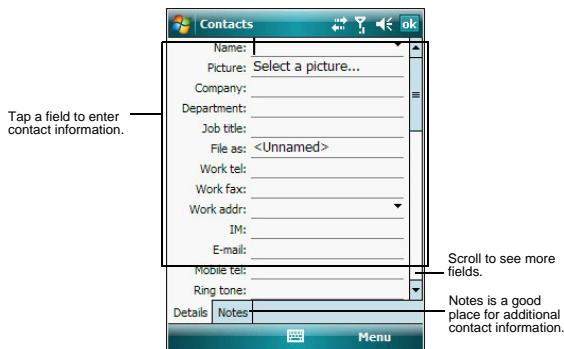



- 2 Using the soft keyboard, enter a name and other contact information.
To select a field, tap it.
Hide the soft keyboard to see all available fields.
- 3 To add notes, tap the **Notes** tab.

6 Using the Windows Mobile Programs *Microsoft Outlook Mobile programs*

4 After completing the contact details, tap **ok**.

To find a contact:

There are several ways to find a contact.

- Using the MC35 keypad, press the starting letter of the contact name
- Tap one of the letter blocks displayed across the top of the contact list.
- Use the Smart Lookup function by entering the first few letters of the contact you're looking for in the search box under the navigation bar. To show all contacts again, clear text from the box or tap the button to the right of the box.
- Tap  > **Programs**  > **Search** , enter the contact name, select **Contacts** for the type, then tap **Search**.

Using the Contacts summary screen

When you tap a contact in the contact list (or select it using the joystick), a summary screen displays. This is referred to as a contact card. To change the contact information, tap **Menu > Edit**.

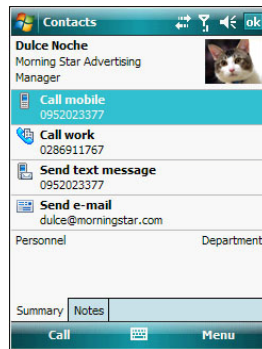

Calling a contact

You can make a call to a contact using either the contact list or the contact card.

To make a call from the contact list:

- Using commands in the pop-up menu.
 - (a) Tap and hold a contact to display a pop-up menu of actions.

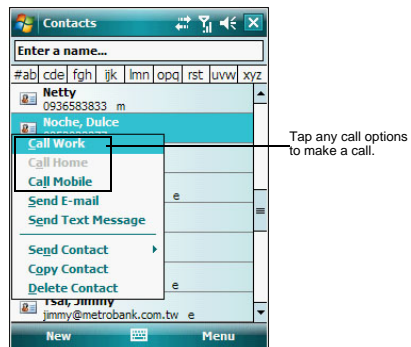

- (b) Tap any of the Call options to make a call.

6 Using the Windows Mobile Programs

Microsoft Outlook Mobile programs

- Using the contact list abbreviation
 - (a) Tap the letter in the right column next to the contact you want to call. The contact's summary screen appears.
 - (b) Tap which number to call or send e-mail/text messages.

The letter that appears opposite a contact entry corresponds to a particular contact information. These are as follows:

 - e – E-mail address
 - e2 – Second e-mail address
 - e3 – Third e-mail address
 - h – Home phone number
 - h2 – Second home phone number
 - m – Mobile phone number
 - pgr – Pager phone number
 - sms – SMS address
 - w – Work phone number
 - w2 – Second work phone number
 - web – Web page
- Using the hardware buttons
 - (a) Move the joystick up or down to scroll through the contact list and select the contact you want to call.
 - (b) Press the **Send** button  twice—once to launch Phone and another to make the call. The call will be made to that contact's priority number.

To make a call from a contact card:

- Tap any of the listed phone numbers.
- Move the joystick up or down to scroll through the listed numbers and select one, then press the joystick or **Send** button  to make the call.

Sending a message to a contact

You can send an e-mail or text message to a contact either from the contact list or from a contact card.

To send a message from the contact list:

- 1 Tap and hold a contact to display a pop-up menu of actions.
- or -

Move the joystick up or down to scroll through the list and select a contact, then press the joystick to display a pop-up menu of actions.

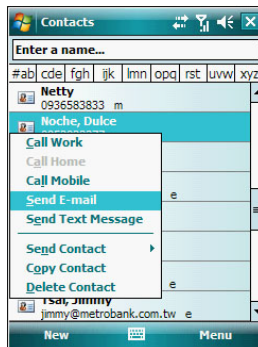

2 Tap **Send E-mail** or **Send Text Message**.

- or -

Move the joystick up or down to select either Send option, then press the joystick to enable it.

Messaging opens to a new message screen with the "To" box automatically filled out with the selected contact's e-mail address/SMS number.

3 Proceed to composing the message.

To send a message from a contact card:

1 Tap any of the listed e-mail/text addresses.

- or -

Move the joystick up or down to scroll through the listed e-mail/text addresses and select one, then press the joystick.

Messaging opens to a new message screen with the "To" box automatically filled out with the selected contact's e-mail/text address.

2 Proceed to composing the message.

Beaming a contact card

You can send a contact card to another IR- or Bluetooth-enabled device either from the contact list or from a contact card screen.

To beam a contact card from the contact list:

1 If you intend to send the contact card:

- Via **IR**: Ensure that the two devices have IR turned on, then align the IR port  of your device with that of the other device so that they are unobstructed and within close range.
- Via **Bluetooth**: Ensure that the two devices have Bluetooth turned on, discoverable, and within close range.

2 Tap and hold a contact to display a pop-up menu of actions.

- or -

Move the joystick up or down to scroll through the list and select a contact, then press the joystick to display a pop-up menu of actions.

3 Tap **Send Contact > Beam**.

4 Tap the device that you want to send the contact card to.

To beam an open contact card:

1 Perform step 1 of the previous section.

2 Tap **Menu > Send Contact > Beam**.

3 Tap the device that you want to send the contact card to.

Synchronizing contacts

- Contacts created on your device are copied to your computer or on a Microsoft Exchange server during synchronization, and vice versa. By default, all of your contacts are synchronized.
- Similarly, contacts that are deleted from your device are deleted from your computer and/or server during synchronization, and vice versa.



6 Using the Windows Mobile Programs

Microsoft Outlook Mobile programs

Tasks

Use Tasks to keep track of what you have to do and prioritize them based on their importance and urgency.

To open Tasks:

- Tap  > **Programs**  > **Tasks** .
- Tasks opens to the task list. To change the way task information is displayed in the list, tap **Menu** > **Options**.

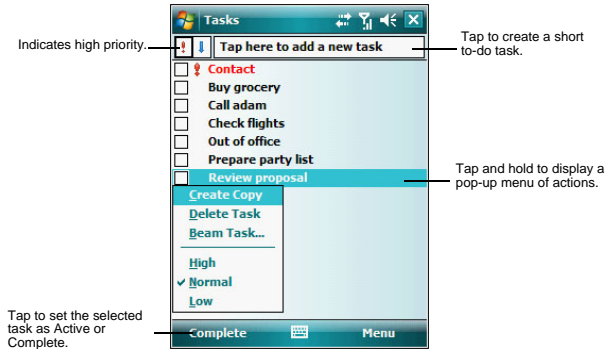

To create a task:

- 1 Tap **Menu** > **New Task**.

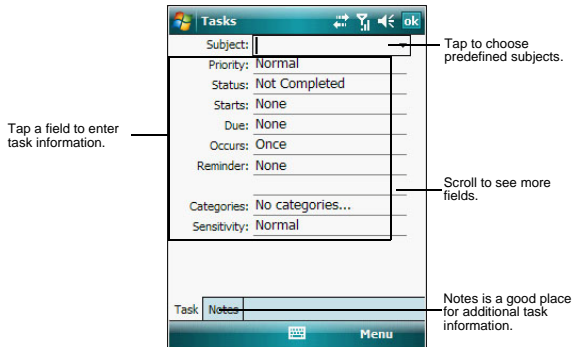

- 2 Using the soft keyboard, enter the task details.
To select a field, tap it.
Hide the soft keyboard to see all available fields.
- 3 To add notes, tap the **Notes** tab.
- 4 After completing the task details, tap **ok**.

Managing tasks

By default all created task items appear as one long list and are named based on their subject line. To keep your tasks organized and allow quick searching you can choose to:

- Filter tasks based on their category or completion status. Tap **Menu** > **Filter**, then select a filter option.
- Sort tasks based on their completion status, priority level, subject, start date, or due date. Tap **Menu** > **Sort By**, then select a sort criteria.

Beaming a task item

You can send a task item to another IR- or Bluetooth-enabled device either from the task list or from a task summary screen.

To beam a task item from the task list:

- 1 If you intend to send the task item:
 - Via **IR**: Ensure that the two devices have IR turned on, then align the IR port  of your device with that of the other device so that they are unobstructed and within close range.
 - Via **Bluetooth**: Ensure that the two devices have Bluetooth turned on, discoverable, and within close range.
- 2 Tap and hold a task item to display a pop-up menu of actions.
- or -
Move the joystick up or down to scroll through the list and select a task item, then press the joystick to display a pop-up menu of actions.
- 3 Tap **Beam Task**.
- 4 Tap the device that you want to send the task item to.

To beam a task item from its summary screen:

- 1 Perform step 1 of the previous section.
- 2 Tap **Menu > Beam**.
- 3 Tap the device that you want to send the task item to.

Using the Tasks summary screen

When you tap a task in the task list, a summary screen displays. To change the task, tap **Edit**.

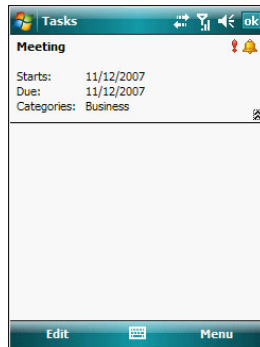

Synchronizing tasks

- Task synchronization is, by default, automatically selected in ActiveSync.
- Tasks can only be synchronized with your computer; they cannot be synchronized with a server.
- Tasks created on your device are copied to your computer during synchronization, and vice versa. By default, only incomplete tasks are synchronized.
- Similarly, tasks that are deleted from your device are deleted from your computer during synchronization, and vice versa.



6 Using the Windows Mobile Programs

Microsoft Outlook Mobile programs

Notes

Quickly capture thoughts, reminders, ideas, drawings, and phone numbers with Notes. You can create a written note or a recording. You can also include a recording in a note. If a note is open when you create the recording, it is included in the note as an icon. If the note list displays, it is created as a stand-alone recording. The option to create notes is integrated in other Outlook Mobile programs.

To open Notes:

- Tap  > **Programs**  > **Notes** .
- Notes opens to the note list.

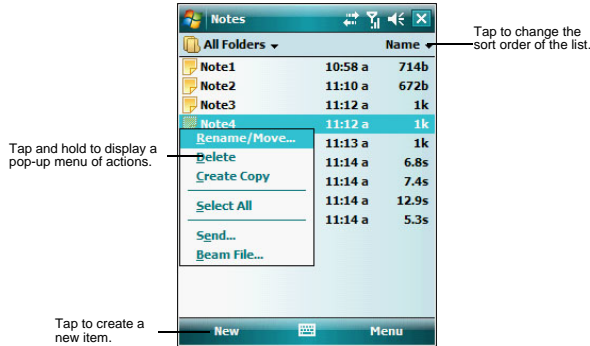

To create a note:

- 1 Tap **New**.
- 2 Compose the note by using any of the Input Selector options, by writing/drawing on the screen, or by creating a recording.

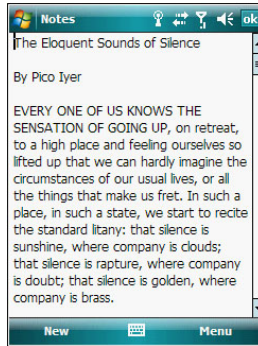

- 3 Once you've completed the note, tap **ok**.

Managing notes

By default all created notes appear as one long list and are named chronologically (i.e., Note1, Note2, etc.). To keep your notes organized you can choose to:

- Move or copy notes to system default folders, or you can create new folders to fit your preferences. This helps you filter your notes and locate them quickly. Select the appropriate command from the pop-up menu or tap **Menu**.

- Rename notes to identify them in a more meaningful manner. Select the appropriate command from the pop-up menu or tap **Menu**.
- Sort notes based on name, date, size, or type to make searching easier. Tap the **Sort By** pick list on the upper right corner of the note list, then select a sort criteria.

Sending a note

You can send a note by beaming it to another person's IR- or Bluetooth-enabled device, or you can send it via e-mail.

NOTE: You must first set up an e-mail account on your device before you can send a note by e-mail. See "Setting an e-mail server connection" on page 63 for more information.

To beam a note from the note list:

- 1 If you intend to send the note:
 - Via **IR**: Ensure that the two devices have IR turned on, then align the IR port  of your device with that of the other device so that they are unobstructed and within close range.
 - Via **Bluetooth**: Ensure that the two devices have Bluetooth turned on, discoverable, and within close range.
- 2 Tap and hold a note to display a pop-up menu of actions.
 - or -
 - Move the joystick up or down to scroll through the list and select a note, then press the joystick to display a pop-up menu of actions.
- 3 Tap **Beam File**.
- 4 Tap the device that you want to send the note to.

To beam an open note:

- 1 Perform step 1 of the previous section.
- 2 Tap **Menu > Tools > Beam**.
- 3 Tap the device that you want to send the note to.

To send a note via e-mail from the task list:

- 1 Tap and hold a note to display a pop-up menu of actions.
 - or -
 - Move the joystick up or down to scroll through the list and select a note, then press the joystick to display a pop-up menu of actions.
- 2 Tap **Send**.

A new message screen displays with the selected note shown as an attachment (*.pwi).
- 3 Proceed to completing the e-mail message.

To send an open note via e-mail:

- 1 Tap **Menu > Tools > Send**.

A new message screen displays with the selected note shown as an attachment (*.pwi).
- 2 Proceed to completing the e-mail message.

Synchronizing notes

- Notes synchronization is, by default, automatically selected in ActiveSync.
- Notes can only be synchronized with your computer; they cannot be synchronized with a server.
- Notes created on your device are copied to your computer during synchronization, and vice versa.
- Similarly, notes that are deleted from your device are deleted from your computer during synchronization, and vice versa.
- Handwritten text or drawings will appear as pictures in your computer.



Messaging

Use Messaging to manage and organize both your e-mail and text (SMS) messages. See "Setting an e-mail server connection" on page 63 for more information on how to set up an e-mail server connection. For instructions on how to use a text messaging service, see "Text messaging service" on page 109.

With Messaging, you can:

- Setup a new e-mail account with an Internet service provider (ISP) or an account that you access using a VPN server connection.
- Synchronize Outlook E-mail messages with Microsoft Outlook on your computer or with a Microsoft Exchange server.
- Send and receive Live Hotmail messages by signing in to Windows Live. See "To sign in to Windows Live" on page 102 for more information.
- Send and receive e-mail messages by connecting directly to an e-mail server through an Internet service provider (ISP) or a network.
- Send and receive text messages through your mobile service subscription. Messaging supports 8 bits data with class 0, 1, 2, 3, as well as USSD (Unstructured Supplementary Service Data).

To open Messaging:

- Tap  > **Messaging** .

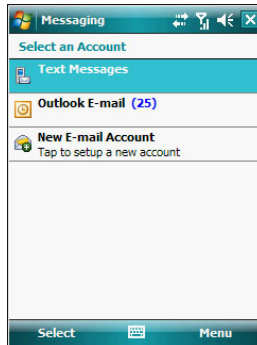

To send and receive e-mail messages:

- Select **Outlook E-mail** on the Messaging screen, then tap **Menu** > **Send/Receive**.

Using the message list

The messages you receive display in the message list. By default, the most recently received messages display first in the list.

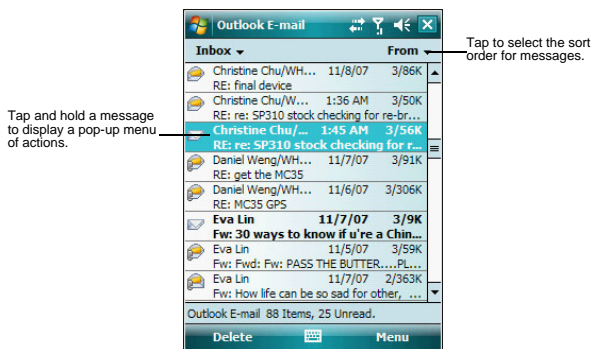

When you receive a message, tap it to open. Unread messages are displayed in bold text.

Creating an e-mail/text message

The following procedures explain how to compose an e-mail message. For procedures on how to compose a text message, see page 109.

To compose an e-mail message:

- 1 In the Outlook E-mail message list, tap **Menu > New**.
- 2 Enter the e-mail address of your intended recipients in the "To" box. You can do this in different ways.

- Manually enter the address using any of the Input Selector options.
- Type the first few letters of an e-mail address that is stored in Contacts, then tap any of the available e-mail addresses. The auto-suggest feature suggests e-mail addresses as you type so that you find them more quickly.
- Tap **Menu > Add Recipient** to display the contact list, then tap a contact from the list.

Make sure multiple e-mail addresses within the same field is separated with a semicolon.

- 3 Compose your e-mail message.

Outlook E-Mail supports the following e-mail options.

- To enter a preset or frequently used messages, tap **Menu > My Text**, then select a message.
- Use the **Menu > Insert** command to attach a picture, voice note, or any file as e-mail attachments.

When attaching a voice note, the Recording toolbar appears for you to create the voice note (file format: .wav); or you can select a previously created voice note (file format: .pwi).

Outlook Mobile now supports attachment of Office Mobile files (Word, Excel, and PowerPoint).

- Use the **Menu > Spell Check** command to search your message for common spelling errors.
- Use the **Menu > Message Options** command to set the priority level, security, and language options.

6 Using the Windows Mobile Programs

Microsoft Outlook Mobile programs

- 4 Tap **Send** when you've finished the message.

If you are working offline, the message is moved to the Outbox folder and sent the next time you're online.

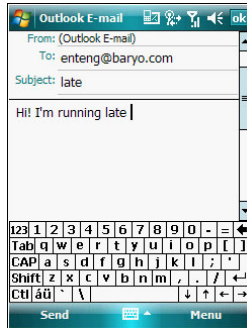

To keep sent items:

By default, sent e-mail messages are not saved on your device to help conserve memory. If you prefer to keep copies of sent e-mail messages, follow the procedure below:

- 1 In the message list, tap **Menu > Tools > Options**.
- 2 On the **Message** tab, select the "Keep copies of sent items in the Sent folder" option.
- 3 Tap **ok**.
- 4 If you are using an Outlook E-mail or a IMAP4 account, select the **Sent Items** folder for synchronization.

For more information on e-mail synchronization options, see "To configure ActiveSync e-mail synchronization settings" on page 79.

Creating a message signature

You can personalize your e-mail and text messages by appending a signature to it. The signature support of your device allows you to create different signatures for your e-mail and SMS account. This feature also eliminates the need to re-type a closing for every message.

To create a signature:

- 1 In the message list, tap **Menu > Tools > Options**.
- 2 On the **Accounts** tab, tap **Signatures**.

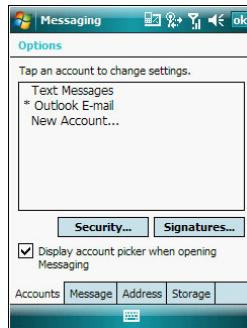

- 3 Tap the pick list to select which account to create a signature for.

- 4 Select the "Use signature with this account" option.
- 5 You can use the signature for new messages only, or you can select the "Use signature when replying and forwarding" option to append it to all outgoing messages.
- 6 Enter a signature in the box.
- 7 Tap **ok**.

Managing messages and folders

By default, messages are displayed in one of five folders for each service you have created—Deleted Items, Drafts, Inbox, Outbox, and Sent Items.

- The behavior of the Deleted and Sent Items folders depends on the options you have chosen. To set these options, in the message list:
 - (a) Tap **Menu > Tools > Options**.
 - (b) On the **Message** tab, select your options.
- If you want to organize messages into subfolders, tap **Menu > Tools > Manage Folders** to create new folders.
- To move a message to another folder, in the message list, tap and hold the message, then tap **Move** on the pop-up menu.

Downloading messages

The manner in which messages are downloaded in your device depends on the type account you have.

- E-mail messages in an Outlook E-mail account can be downloaded during ActiveSync synchronization.
- E-mail messages in a Windows Live Hotmail account can be downloaded when signed into Windows Live.
- E-mail messages in an e-mail account provided by your ISP, or that you access using a virtual private network (VPN) server can be downloaded from a remote e-mail server.
- Text messages are automatically received by your device when the phone function is turned on. When the phone function is disabled, messages are held by your mobile phone service provider until the next time you turn the phone function on.

Synchronizing Outlook e-mail messages

Outlook e-mail messages can be synchronized as part of the general ActiveSync synchronization process.

During ActiveSync synchronization:

- Only the first 500 bytes (or characters, including spaces) of each new message sent to you within the last three days.
- Messages are copied from the Outlook Inbox folder on your computer, or from a Microsoft Exchange server, to the Outlook E-mail Inbox folder on your device.
- The messages on your device and on your computer are linked. When you delete a message on your device, it is also deleted from your computer the next time you synchronize, and vice versa.

To set up ActiveSync e-mail synchronization:

- 1 Open ActiveSync on your computer.
- 2 Click **Tools > Options**.
- 3 In the **Mobile Device** list under the Desktop area, select the "E-mail" option.
- 4 Click **OK**.

To configure ActiveSync e-mail synchronization settings:

- 1 Connect your device to your computer.
- 2 On ActiveSync on your computer, make sure the details pane is open. If it's not, click **Show Details**.
- 3 Double-click **E-Mail**.
- 4 Select the e-mail synchronization options you prefer.
 - If you receive long messages often and want to synchronize them in full, select a larger size in the "Limit e-mail size to" list.
 - If you want to synchronize more past messages, increase the interval in the "Include the previous" box.

6 Using the Windows Mobile Programs

Microsoft Office Mobile programs

- If you want to include e-mail attachments, select the "Include file attachments" option. To limit the size of synchronized attachments, select the "Only if smaller than" option and enter a size limit. Attachments larger than this limit will not be synchronized with your device.
- If you want to synchronize folders other than Inbox, click **Select Folders**, then select the subfolders that you want to synchronize.
The Deleted Items folder synchronizes only one direction, from the device to the computer. Items in the Deleted Items folder on your computer will not appear on your device.

5 Click **OK** twice.

Synchronizing POP3/IMAP4 e-mail messages

POP3/IMAP4 e-mail messages are downloaded using an e-mail server connection. During e-mail server synchronization:

- New e-mail messages are downloaded to that account's Inbox folder.
- E-mail messages in that account's Outbox folder are sent.
- E-mail messages that have been deleted in the e-mail server are removed from your device's Inbox folder.
- If you are using a POP3 account and you move e-mail messages to a folder you created, the link is broken between the messages on your device and their copies on the e-mail server. The next time you connect, the e-mail server sees that the messages are missing from the device's Inbox and delete them from the server. This prevents you from having duplicate copies of a message, but it also means that you will no longer have access to messages that you move to folders created from anywhere except your device.
- If you are using an IMAP4 account, the folders you create and the e-mail messages you move are mirrored on the server. Therefore, messages are available to you anytime you connect to your e-mail server, whether it is from your device or from your computer. This synchronization of folders occurs whenever you connect to your mail server, create new folders or rename/delete folders when connected.

To synchronize POP3/IMAP4 e-mail messages:

- 1 On the message list on your device, tap **Menu > Go To**, then select the e-mail account you want to use.
- 2 Tap **Menu > Send/Receive**.

Microsoft Office Mobile programs

Microsoft Office Mobile includes the mobile versions of the popular Word, Excel, and PowerPoint programs. With these mobile programs, you maintain a productive work schedule even while on-the-go.





Word Mobile

Use Word Mobile to:

- Create and edit documents and templates and save them as .doc, .rtf, .txt, and .dot files.
- Edit Word documents and templates created on your computer. You can also open and edit Pocket Word (*.psw) documents.
- Synchronize documents and templates between your device and your computer.

To open Word Mobile:

- Tap  > **Office Mobile**  > **Word Mobile** .
- The Word Mobile document list displays.

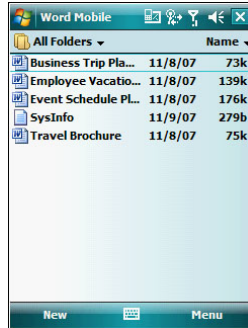

Using the Word Mobile document list

The Word Mobile document list is the default screen when you open Word Mobile. Every time you tap **ok** in an open document, this list displays.

- Tap a file in the document list to open it. You can open only one document at a time.
- To delete, make copies of, and send files, tap and hold a file in the list, then select the appropriate action on the pop-up menu.

Creating a Word Mobile document

Word Mobile has built-in templates for creating a new document, meeting notes, memo, phone memo, and to do list.

To change the default template:

- 1 On the document list, tap **Menu > Options**.
- 2 Select another template from the "Default template" pick list.
- 3 Tap **ok**.

To create a new document:

- 1 On the document list, tap **New**.
A new document appears based on the default template.
- 2 Enter the information using any of the Input Selector options.
- 3 Format texts by using the Word Mobile toolbar.
This toolbar provides basic formatting options, such as font style, paragraph alignment, and bullet options. You can show and hide this toolbar by tapping **View > Toolbar**.
- 4 Tap **ok**.
This will close the newly created document and automatically name the file after the first several words in the document. The new document is placed in the Word Mobile document list.

- or -

6 Using the Windows Mobile Programs

Microsoft Office Mobile programs

Tap **Menu > File > Save As** to customize the save settings.

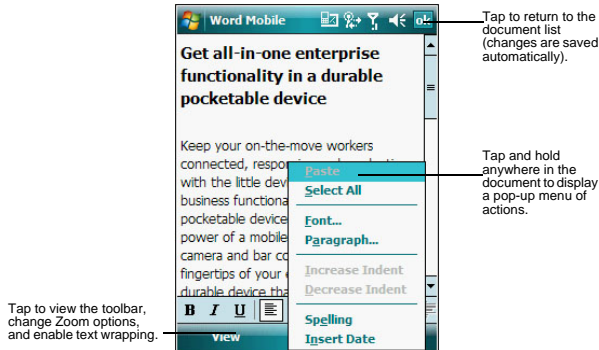

Tips for working in Word Mobile

- If you're opening a Word document created on a computer, select **Wrap to Window** on the View menu so that you can see the entire document.
- You can change the zoom magnification by tapping **View > Zoom**, then select the percentage you want. Select a higher percentage to enter text and a lower one to see more of your document.

Sending a Word Mobile document

You can send a Word Mobile document by beaming it to another person's IR- or Bluetooth-enabled device or send it as an attachment via e-mail.

To beam a document:

- 1 If you intend to send the document:
 - Via **IR**: Ensure that the two devices have IR turned on, then align the IR port — of your device with that of the other device so that they are unobstructed and within close range.
 - Via **Bluetooth**: Ensure that the two devices have Bluetooth turned on, discoverable, and within close range.
- 2 From the Word document list, select the item you want to beam.
- 3 Tap **Menu > Beam File**.
- 4 Tap the device that you want to send the file to.

To send a document via e-mail from the document list:

NOTE: Make sure that your device is properly setup to send and receive mail. See "Getting connected" on page 60 for more information.



- 1 From the Word document list, select the item you want to send.
- 2 Tap **Menu > Send**.
A new message screen displays with the selected file shown as an attachment.
- 3 Proceed to completing the e-mail message.
- 4 Tap **Send**.

To send an open document via e-mail:

- 1 Tap **Menu > File > Send**.
A new message screen displays with the file shown as an attachment.
- 2 Proceed to completing the e-mail message.

Synchronizing Word documents

You can synchronize Word documents created on your computer with your device. Note the following reminders when selecting this option.

- Word Mobile does not support synchronization of password-protected files. You must first remove the password protection in Word on your computer if you want to view the document on the device.
- ActiveSync need to convert your computer document files before synchronizing it with your device. Converted files may not contain all information found in original file. For more information, on the Word Mobile document list, tap  > **Help** , then locate the [Unsupported features in Word Mobile](#) link.

To synchronize Word documents:

- 1 Connect your device to your computer.
- 2 Click **Tools > Options**.
- 3 Select the "Files" option.
This will create the <device name> My Documents folder on your computer's desktop.
- 4 Place all the Word documents you want to synchronize with your device in this folder.
- 5 Initiate synchronization.
The documents you placed on the <device name> My Documents folder are copied to your device.





Excel Mobile

Use Excel Mobile to:

- Create, view, and edit workbooks and save them as .xls and .xlt files.
- Edit Excel workbooks and templates created on your computer.
- Create, view, and edit charts/graphs and save them in a separate worksheet or embed them as objects in the source worksheet.
- Synchronize Excel workbooks and templates between your device and your computer.

To open Excel Mobile:

- Tap  > **Office Mobile**  > **Excel Mobile** .
- The Excel Mobile workbook list displays.

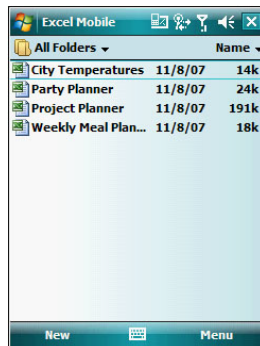

Using the Excel Mobile workbook list

The Excel Mobile workbook list is the default screen when you open Excel Mobile. Every time you tap **ok** in an open workbook, this list displays.

- Tap a file in the workbook list to open it. You can open only one workbook at a time.

6 Using the Windows Mobile Programs

Microsoft Office Mobile programs

- To delete, make copies of, and send files, tap and hold a file in the list, then select the appropriate action on the pop-up menu.

Creating an Excel Mobile workbook

Word Mobile has built-in templates for creating a blank workbook and a vehicle mileage log.

To change the default template:

- 1 On the workbook list, tap **Menu > Options**.
- 2 Select another template from the "Template for new workbook" drop-down list.
- 3 Tap **ok**.

To create a new workbook:

- 1 On the workbook list, tap **New**.

A new workbook appears based on the on default template.

- 2 Perform any of the following.
 - Tap a cell, enter the information (values, text, formula), then tap **Enter**. If you're entering a formula, enter the equal sign (=) first.
Tap **Help**  for more information on how to perform more advanced workbook tasks.
 - Use the Excel toolbar. It has tools for working with formulas, functions, and charts; as well as options for sorting and filtering data. You can show and hide this toolbar by tapping **View > Toolbar**.
 - A new workbook by default has only three worksheets. To add more worksheets, tap **Menu > Format > Modify Sheets > Insert**.
- 3 Tap **ok**.

This will close the newly created workbook and automatically name the file as Book#. The new document is placed in the Excel Mobile workbook list.

- or -

Tap **Menu > File > Save As** to customize the save settings.

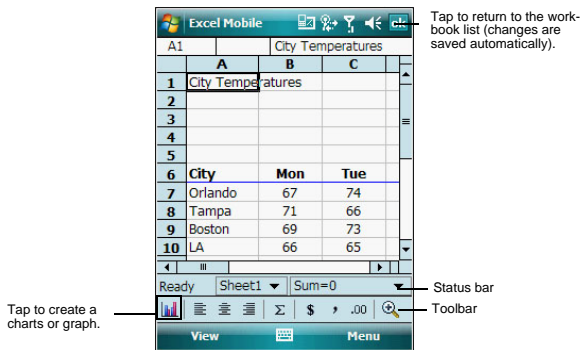

Tips for working in Excel Mobile

Note the following when working in large worksheets.

- View in full-screen mode to see as much of your worksheet as possible.
 - Tap **View > Full Screen**.
 - To exit full screen mode, tap **View**, then deselect **Full Screen**.
- Show and hide screen elements.
 - Tap **View**, then tap the elements you want to show or hide.
- You might want to freeze the top and left-most panes in a worksheet to keep row and column labels visible as you scroll through a sheet.
 - (a) Select the cell where you want to freeze panes.
 - (b) Tap **View > Freeze Panes**.

- Split panes to view different areas of a large worksheet.
 - (a) Tap **View > Split**.
 - (b) Drag the split bar to where you want it.To remove the split, tap **View > Remove Split**.
- Show and hide rows and columns.
 - To hide a row or column:
 - (a) Select a cell in the row or column you want to hide.
 - (b) Tap **Menu > Format > Row or Column > Hide**.
 - To display a hidden row or column:
 - (a) Select the cells which span the hidden row or column.
 - (b) Tap **Menu > Format > Row or Column > Unhide**.

Sending an Excel Mobile workbook

You can send an Excel Mobile workbook by beaming it to another person's IR- or Bluetooth-enabled device, or you can send it as an e-mail attachment. You can do any of these in the same manner as you do with a Word Mobile document. See "Synchronizing Word documents" on page 83 for more information.

Synchronizing Excel workbooks

You can synchronize Excel workbook created on your computer with your device. You can do this in the same manner as you do with Word documents. See "Synchronizing Word documents" on page 83 for more information.



PowerPoint Mobile

Use PowerPoint Mobile to view slide show presentations. You can download slide show presentations from a storage card, company network, internet, e-mail attachment or obtained by synchronizing with your personal computer.

To open PowerPoint Mobile:

- Tap  > **Office Mobile**  > **PowerPoint Mobile** .

Getting slide shows onto your device

You can download PowerPoint files from a memory card or the Web to your computer, then synchronize them with your device. To do so, you need to activate your device (you only need to activate it once), then set up synchronization for files in ActiveSync.

To get slide show presentation onto your device:

- 1 Open ActiveSync on your computer.
- 2 Use Windows Explorer on your computer to locate the PowerPoint Mobile folder and the Pocket PC My Documents folder.
- 3 Use ActiveSync to download the files from your computer to your device as described in the Read Me file in the PowerPoint Mobile folder.

Using PowerPoint Mobile

PowerPoint Mobile contains a list of files stored on your device. The file list is the default screen when you open PowerPoint Mobile.

6 Using the Windows Mobile Programs

Microsoft Office Mobile programs

To open a PowerPoint presentation:

- 1 Tap  > Office Mobile  > PowerPoint Mobile .

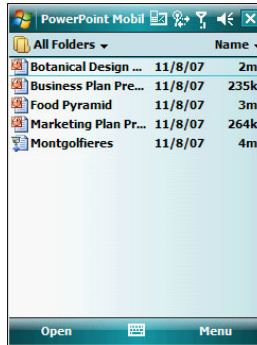

- 2 Tap the slide show you want to view.



- 3 Tap the current slide to advance to the next slide.

To stop a slide show presentation:

In a PowerPoint Mobile presentation, tap and hold , then tap **End Show**.

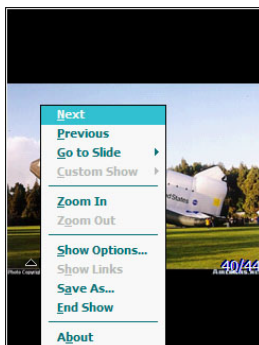

To change the slide show presentation:

- 1 In a PowerPoint Mobile presentation, tap and hold , then tap **Show Options**.
- 2 Tap the **Orientation** tab, then select the orientation.

To navigate between slides:

- 1 In a PowerPoint Mobile presentation, tap and hold the , then tap **Go to Slide**.
- 2 Tap the slide you want to view.

Setting the slide show playback options

You can change the PowerPoint presentation settings to turn off animation, prevent slide show transitions from playing, or set time interval between each slide.

To set the slide show playback options:

- 1 In a PowerPoint Mobile presentation, tap and hold the , then tap **Show Options**.
- 2 Tap the **Playback** tab; select the **Override playback options for all files** check box.
- 3 Perform any of the following:
 - Select the "Show without animation" option to turn off builds and other animations.
 - Select the "Show without slide transition" option to prevent slide transitions from playing.
 - Select the "Use slide timings, if present" option to use the timings recorded with each slide in a presentation.
 - Select the "Loop continuously" option to automatically advance to the first slide after the last slide in a presentation.
- 4 Tap **ok**.

Sending a PowerPoint file

You can send a PowerPoint file to another person either by e-mail or by beaming it to that person's IR- or Bluetooth-enabled device.

NOTE: You must first set up an e-mail account on your device before you can send a PowerPoint file by e-mail. See "To set up an e-mail account" on page 63 for more information.

6 Using the Windows Mobile Programs

Windows Media Player

To send a PowerPoint file by beaming:

- 1 In the PowerPoint document list, tap and hold the document.
- 2 Tap **Beam File** on the pop-up menu.
- 3 Perform one of the following:
 - Select a Bluetooth-enabled device, then tap the **Tap to send link**.
 - Align the IR port  of your device with that of the other IR-enabled device so that they are unobstructed and within close range, then select the IR-enabled device and tap the **Tap to send link**.

To send a PowerPoint file by e-mail:

- 1 In the PowerPoint document list, tap and hold the document.
- 2 Tap **Send via E-mail** on the pop-up menu.

A new message screen in Inbox displays with the selected note shown as an attachment (*.pwi).
- 3 Proceed to completing the e-mail message.

Windows Media Player

Enjoy your favorite music and movies on the road, online or offline, with the new Windows Media Player 10 Mobile for Pocket PC. The Player provides you with the highest quality audio and video experience for your mobile entertainment and it works seamlessly with Windows Media Player 10 on your Windows XP-based computer.

Copying files to your device

Use the Sync feature in Windows Media Player 10 on your computer to copy your digital media files to your device. Using the Player, instead of simply copying files using the Explore button in ActiveSync, ensures that licenses are copied with protected files.

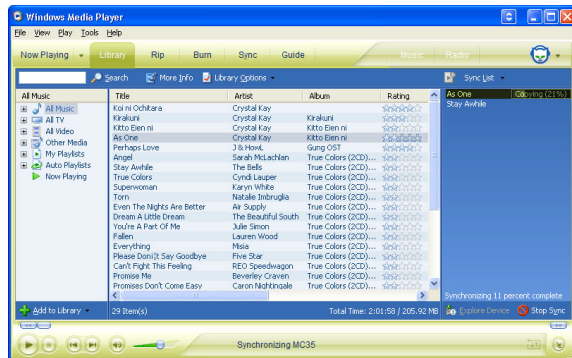

- 1 In Windows Media Player on your computer, click the **Library** tab (you must first connect your device to your computer).
- 2 In the **Playlist** pane, click the playlist, category, or other item that you want to copy.
- 3 On the top right side of the screen, click **Now Playing List**, then select **Sync List**.
- 4 Drag the items from middle portion of the screen to the **Sync List** pane to add them to the list of items to be synchronized.
- 5 Click **Start Sync** at the bottom right corner of the screen.



Windows Media Player verifies that there is sufficient storage space on your device to copy the selected files. If there is sufficient space, the files are converted (if necessary) and copied. If the device has insufficient storage space, **May not fit** appears next to the selected items in the **Sync List** pane.

NOTE: To facilitate faster copying of audio files to your device, it is recommended that you configure Windows Media Player 10 on your computer to automatically determine the quality level settings applicable to your MC35 EDA. See the Windows Media Player Help on your computer for more information.

To open Windows Media Player 10 Mobile for Pocket PC:



- Tap  > **Programs**  > **Windows Media** .
The Player displays the last open screen from your previous session.

The library

The library contains links to your playlists and audio or video files. You can sort content by criteria such as artist name, album title or genre. By default, Windows Media Player 10 Mobile automatically searches your device for compatible digital media files and adds them to the My Device library. Similarly, when you insert a storage card into your device, Windows Media Player 10 Mobile automatically detects the files and adds them to the Storage Card library.

To update the library:

If the Player does not detect new files that you copy to your device, you can manually update the library.

- 1 Tap  > **Programs**  > **Windows Media** .
- 2 Tap **Menu** > **Update Library**.

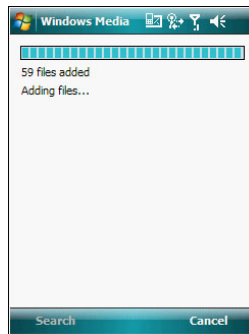

- 3 Wait for files to be added, then tap **Done**.

The playlist

A playlist is a customized list of digital media files that you want to watch or listen to. Using a playlist lets you group various digital media files together and specify the order you want the files to play in. You can also use playlists to copy files to your computer.

You can create a playlist based on:

- **Source** - For example, tracks from various CDs of your favorite artist or streaming media from an online music site.
- **Personal preferences** - For example, a playlist of tracks belonging to your favored music genre or video clips from your funny movie collection.
- **Mood or activities** - For example, a playlist of tracks you want to listen while travelling or during your R&R periods.

The Player has two default playlists:

- **Local Content** - Consists of all compatible audio and video files stored on your device and/or storage card.
- **Web Favorites** - Consists of your favorite streaming media files. This playlist is empty until you add items to it.

6 Using the Windows Mobile Programs

Windows Media Player

To add items to the Now Playing playlist:

- 1 On the Library screen, tap **Menu > Library**.

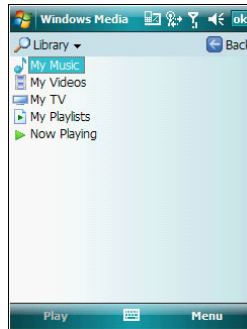

- 2 Select a library in the Library pick list (for example a storage card).

TIP: If the Player does not detect new files that you copied to your device, you can manually update the library by tapping **Menu > Update Library**. After the files have been added, tap **Done**.

- 3 Select a category, then tap and hold the item that you want to add in the Now Playing folder.
- 4 Tap **Queue Up**.

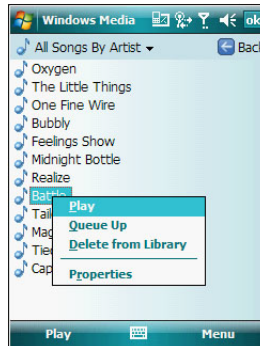

- 5 Tap **Menu > Now Playing**.
- 6 On the Now Playing screen, tap  to switch to the Library screen and find items to add to the Now Playing playlist.

NOTE: To quickly add a group of files to the Now Playing playlist, tap and hold an item in the library (such as an album name, artist name or genre), then tap **Queue Up**.



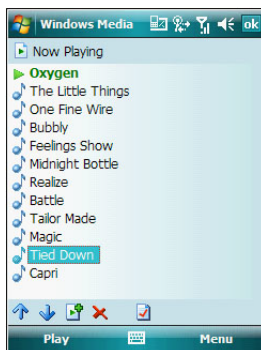

To edit the Now Playing playlist:

- 1 On the Player screen, tap **Now Playing**.
- or -

Tap **Menu > Library > Menu > Now Playing**, then the playlist you want to edit.



2 Perform any of the following:

- Tap  to move the selected item up in the playlist. You can also tap and drag an item to move it up in the playlist.
- Tap  to move the selected item down in the playlist. You can also tap and drag an item to move it down in the playlist.
- Tap  to display the Library screen and add items to the Now Playing playlist.
- Tap  to delete the selected item from the playlist.
- Tap  to view track properties of the selected item.

To delete an item in the Now Playing playlist:

- 1 On the **Playback** screen, tap **Now Playing**.
- 2 Tap and hold the item you want to delete, then tap **Remove from Playlist** from the pop-up menu.

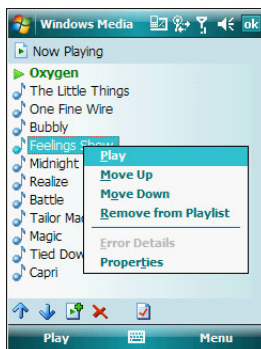

- or -

Tap an item you want to delete, then tap **Menu > Remove from Playlist**.

Viewing track properties

You can check the file properties of a track for your reference. You can do this either in a playlist screen or in the Player screen.

6 Using the Windows Mobile Programs

Windows Media Player

To view track properties from a playlist:

- 1 On the Library screen, tap **My Playlists**.

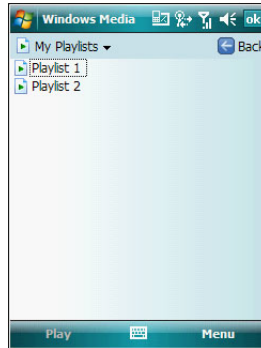

- 2 Tap a playlist category.
- 3 On the Playlist screen, tap or play a file.
- 4 Tap **Menu > Properties**.



- 5 Tap the scroll bar to view more fields.
- 6 Tap **ok**.

To view track properties from the Player screen:

- On the Playback screen, tap **Menu > Properties**.

- or -

On the Playback screen, tap **Now Playing**, then tap 

Tap the scroll bar to view more fields.

File Playback

The Player supports playback of the following file formats:

- Windows Media - Including .asf, .asx, .wax, .wm, .wma, .wmv, .wmx, and .wvx files.
- MPEG - .mp3 files

You can play files stored in your device, a storage card, or a network.

Playing a file stored in your device or in a storage card

If you want to use files stored in a storage card, install the card to your device. See “To insert a storage card” on page 12 for more information.

- 1 On the **Playback** screen, tap **Now Playing**.

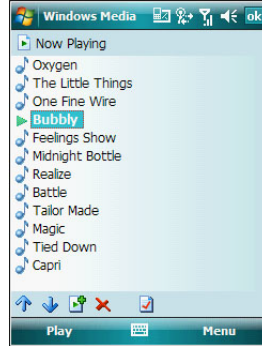

- 2 Tap , then the playlist/location where the file you want to play is assigned/located.
- 3 Tap **Play**.

Screen shifts to the Player screen. Unless you selected the last listed track in a playlist or location, the rest of the tracks will automatically be played.

Playing a streaming media file

You can play files located on a network. Your device must first be connected to the network before you can do this.

- 1 On the **Playback** screen, tap **Menu > Library**.
- 2 Tap **Menu > Open URL**.

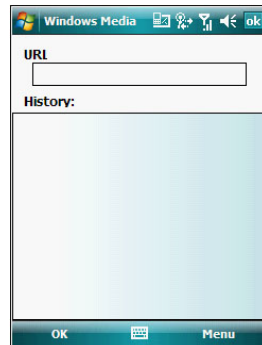

- 3 Enter a URL.
 - 4 Tap **ok**.
- Screen shifts to the Player screen.

6 Using the Windows Mobile Programs

Windows Media Player

Playback controls

The user interface of the Windows Media Player Mobile Playback screen lets you easily manage all aspects of the track playback. The screenshot below shows the functions of the Playback control buttons, as well as all available menus.



To play a playlist in random order:

- Tap **Menu > Shuffle**.

To repeat playback of a playlist:

- Tap **Menu > Repeat**.

Customizing the Player

You can change the appearance and functionality of the Player to suit your personal style and preferences.

Using skins to change the Player look

Change the appearance of the Player by using skins. To download skins and learn related information, go to <http://www.microsoft.com/windows/windowsmedia/>.

To download skins from your computer to your device, follow the procedures described in the "Using ActiveSync to copy files" section on page 37.

NOTE: To make sure that downloaded skins appear in the Skin Chooser panel, do not store the skin files in the Windows folder of your device.

To change Player appearance:

- 1 On the **Playback** screen, tap **Menu > Options > Skins** tab.
- 2 Tap the **Previous** or **Next** button to locate a skin.

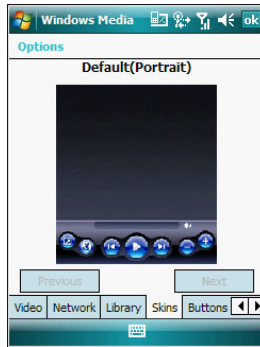

- 3 Tap **ok**.
The Player switches to skin mode.

Changing your audio and video settings

You can change the audio and video settings of the Player to suit your listening preferences.

To set audio and video preferences:

- 1 On the **Playback** screen, tap **Menu > Options > Playback** tab.
- 2 Perform the following:
 - In the "Show time as" list, select whether to show how much time has elapsed or remaining on the Playback screen.
 - Tap the "Pause playback while using another program" check box, to pause or continue playback when another program screen is displayed.
 - Select the "Resume playback after a phone call" option, to continue playback after a phone call.

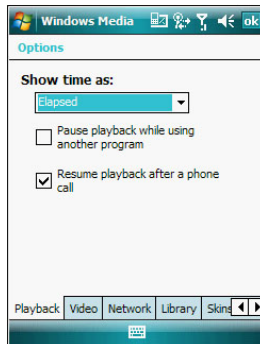

6 Using the Windows Mobile Programs

Windows Media Player

- 3 Tap the **Video** tab, then perform the following:
 - In the "Play video in full screen" list, select a screen size for video playback.
 - Select the "Scale to fit in window" option to scale down oversized video files (typically over 240 x 176 pixels).

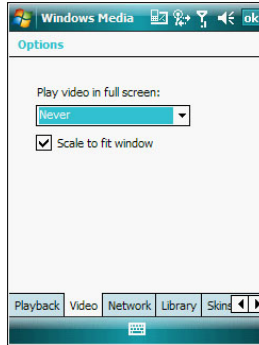

- 4 Tap **ok**.

Changing your network settings

You can define Player settings for connecting to a network to optimized playback of streaming media.

To set network settings:

- 1 On the **Playback** screen, tap **Menu > Options > Network** tab.
- 2 Select the check box opposite each network protocol you want to enable.
You must select at least one protocol.

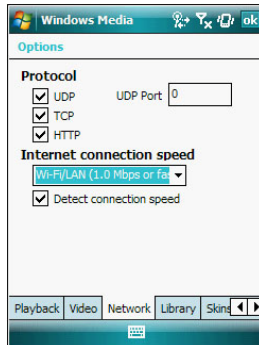

- 3 Select the speed of your network connection.
- 4 Tap **ok**.

NOTE: Some networks use a firewall that prevents users from receiving streams. Contact your network administrator for more information.

Changing the startup screen

You can define the startup screen when you start the Windows Media Player Mobile.

To change the startup screen:

- 1 On the **Playback** screen, tap **Menu > Options > Library** tab.
- 2 Perform one of the following:
 - Select the "Start Player on Library screen" option, to show the Library screen when you start the Windows Media Player Mobile.
 - Clear the "Start Player on Library screen" check box, to show the Playback screen when you start the Windows Media Player Mobile.

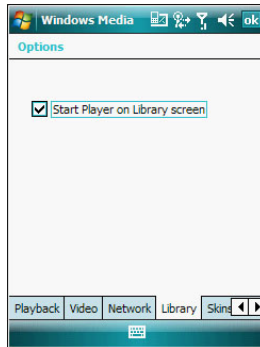

- 3 Tap **ok**.

Setting hardware playback controls

The button mapping function allows you to assign hardware buttons on your device to perform standard playback functions. You can also assign a button to toggle off the screen to help minimize power consumption while continuing to listen to music.

To map a button:

- 1 On the **Playback** screen, tap **Menu > Options > Buttons** tab.

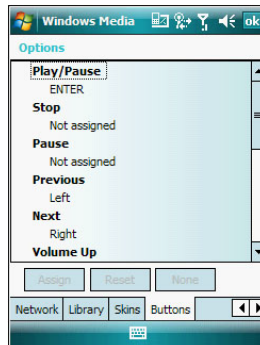

- 2 In the list of controls, tap a control name.
- 3 Tap the **Assign** button, then press the hardware button on your device.
- 4 Tap **ok**.

6 Using the Windows Mobile Programs

Internet Explorer Mobile

Licenses and Protected files

Some digital media content from the Internet, CD tracks, and videos have associated licenses that protect them from being unlawfully distributed or shared.

Licenses are managed and created using digital rights management (DRM), which is the technology for securing content and managing the rights for its access.

Some licenses may prevent you from playing files that are copied to your device. Files that have licenses associated with them are called protected files.

Use the Windows Media Player on your computer to copy your digital media files to your device. Using the Player, ensures that licenses are copied with protected files.

For more information on using Windows Media Player for Pocket PC, tap  > **Help** .

Internet Explorer Mobile

Use Internet Explorer Mobile to view Internet or Intranet sites from your device. You can download files and programs when browsing these sites. During synchronization with your computer, you can choose to download your favorite links and mobile favorites that are stored in the Mobile Favorites subfolder of Internet Explorer on your computer.

Internet Explorer Mobile includes support for:

- XHTML Basic
- Cascading Style Sheets
- WML 2.0
- JavaScript 5.5
- IPv6

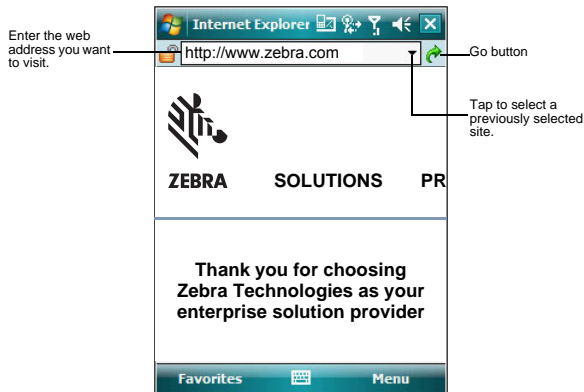

To open Internet Explorer Mobile:

- Tap  > **Internet Explorer** .

Browsing the Internet

To connect and start browsing:

Perform any of the following:

- Tap **Menu** > **Favorites**, then tap the favorite you want to view.
- In the **address** bar that appears at the top of the screen, enter the Web address you want to visit, then tap .
- Tap the **Address Bar** pick list to choose from previously entered addresses.

Viewing the History list

- Tap **Menu > History**.

To change the number of days of links stored in the History list and clear the History list:

- 1 On the *Internet Explorer Mobile* main screen, tap **Menu > Tools > Options > Memory** tab.

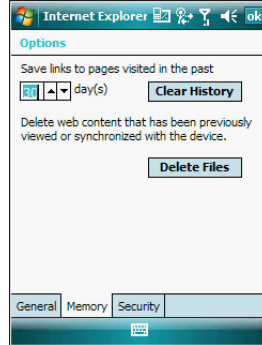

- 2 Tap the pick list under "Save links to pages visited in the past" to set the number of days of links.
- 3 Tap **Clear History** to delete the stored links.
- 4 Tap **ok**.

Mobile favorites

To display the Mobile Favorites navigation screen:

- 1 Tap **Menu > Favorites**.

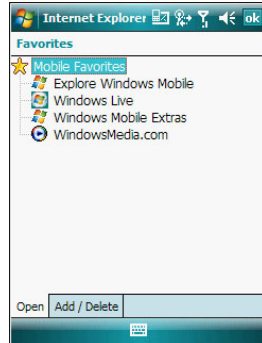

- 2 Tap the page you want to view.
The page that was downloaded the last time you synchronized with your computer displays. If the page is not on your device, the favorite is dimmed. Synchronize with your computer again to download the page to your device, or connect to the Internet to view the page.

6 Using the Windows Mobile Programs

Internet Explorer Mobile

To add a favorite link:

- 1 While on the page you want to add, tap and hold on the page.
- 2 Tap **Add to Favorites** from the pop-up menu.

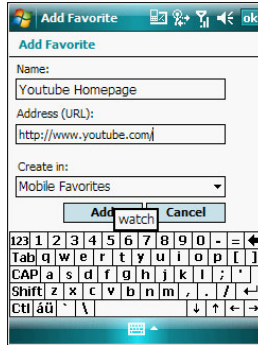

- 3 Make the changes you want on the **Name** and **Address** boxes.
- 4 In the **Create in** list, select the folder where you want the link to be stored.
- 5 Tap **Add**, then tap **ok**.

Mobile Favorites folder

Only items stored in the Mobile Favorites subfolder of the Favorites folder of Internet Explorer on your computer are synchronized with your device. This folder was created when you selected the Favorites information type for ActiveSync synchronization with your computer.

Favorite Links

During synchronization, the list of favorite links in the Mobile Favorites folder on your computer is synchronized with Internet Explorer Mobile on your device. Both locations are updated with changes made to either list each time you synchronize. Unless you mark the favorite link as a mobile favorite, only the link will be downloaded to your device, and you will need to connect to your ISP or network to view the content.

Mobile Favorites

If you are using Microsoft Internet Explorer 5.0 or later on your computer, you can download mobile favorites to your device. Synchronizing mobile favorites downloads Web content to your device and enables you to view pages while you are disconnected from your ISP and computer. To quickly create mobile favorites, use the Internet Explorer plug-in installed with ActiveSync.

To create a mobile favorite:

- 1 In Internet Explorer on your computer, click **Tools > Create Mobile Favorite**.
- 2 To change the link name, enter a new name in the Name box.
- 3 Optionally, in Update, select a desired update schedule.

If you did not specify an update schedule, you need to manually download content to keep the information updated on both your computer and device. Before synchronizing with your device, in Internet Explorer on your computer, click **Tools**, then **Synchronize**. You will see the last time content was downloaded to the computer, and you can manually download content if needed.

- 4 Click **OK**.

Internet Explorer downloads the latest version of the page to your computer.

TIP: You can add a button to the Internet Explorer toolbar for creating mobile favorites. In Internet Explorer on your computer, click **View > Toolbars > Customize**.

To download a mobile favorite:

- 1 Right-click the mobile favorite, then click **Properties**.
- 2 On the **Download** tab, specify the number of links deep you want to download.
To conserve device memory, go only one level deep.
- 3 Synchronize your device and computer.
Mobile favorites that are stored in the Mobile Favorites folder in Internet Explorer are downloaded to your device.

To save device memory in downloading mobile favorites:

Mobile favorites take up storage memory on your device. To minimize the amount of memory used, observe the following:

- In the settings for the Favorites information type in ActiveSync options, turn off pictures and sounds, or top some mobile favorites from being downloaded to your device.
- Limit the number of downloaded linked pages. In Internet Explorer on the computer, right-click the mobile favorite you want to change, then click **Properties**. On the **Download** tab, specify 0 or 1 for the number of linked pages you want to download.

Windows Live

Windows Live includes support for the following:

- **Live Hotmail Mobile**
You can read, write and send e-mail, delete e-mail and manage your Hotmail folder.
- **Live Messenger Mobile**
See who's online. Send and receive instant messages. Subscribe to status update for selected contacts so you are notified when they are online.
- **Live Sync**
You can sync contacts and e-mail between your device and Windows Live.
- **Live Search bar**
Launch a personalized browser that offers e-mail access and a portal that allows access to customized stock lists, weather, sports, entertainment and news headlines.

To open Windows Live:

- 1 Tap  > **Programs**  > **Windows Live** .

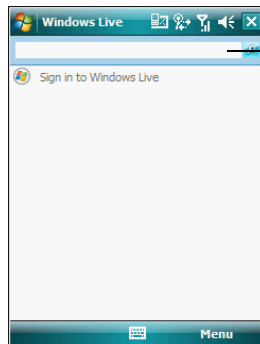

Enter query in the
Live search bar.

6 Using the Windows Mobile Programs

Windows Live

To sign in to Windows Live:

Signing in to Windows Live helps to maintain a secure access to your Live Hotmail and Live Messenger accounts.

- 1 On the Today screen, tap  **Sign in to Windows Live.**

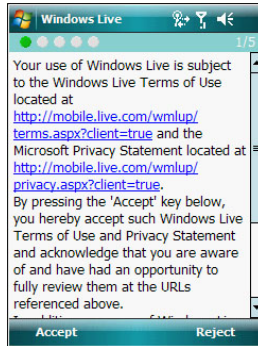

- 2 Tap **Accept** to agree to Terms of Use.

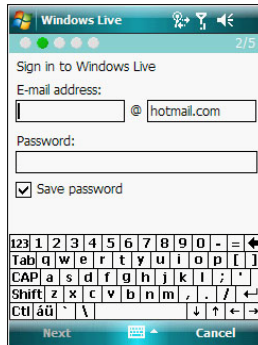

- 3 Enter your sign-in e-mail address and password.
Select the "Save password" option so you need not enter these information again the next time you sign in.

- 4 Tap **Next**.

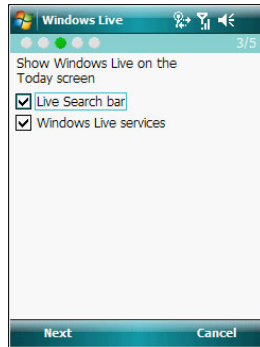

- 5 Follow the on-screen instructions to complete sign-up.
After completing the sign-up, your Windows Live display name, display picture, and connection status appears on the Today screen.

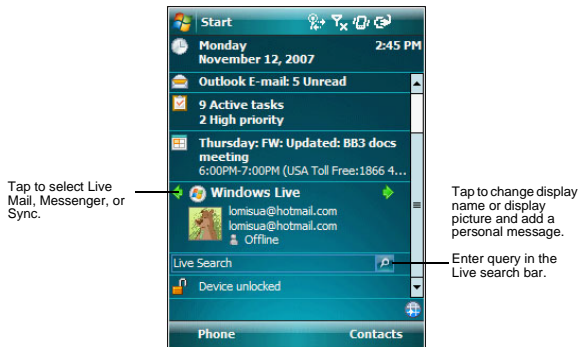

For more information on how to use Windows Live, visit <http://support.live.com>.

Live Hotmail



Windows Live Hotmail on your device lets you access your Live Hotmail Inbox.

NOTE: Make sure you create a connection to the internet before using Windows Live Mail.

To view your Windows Live Mail Inbox:

- 1 Sign in to Windows Live. See previous section for instructions.

6 Using the Windows Mobile Programs *Windows Live*

- 2 On the Today screen, tap  and select **Mail** .

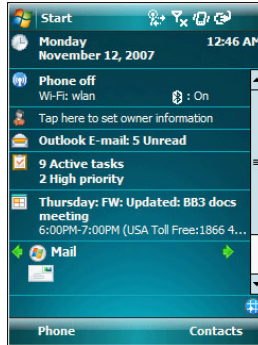

- 3 To synchronize your Windows Live Inbox so you see your latest e-mail messages, tap **Menu > Send/Receive**.



To create an e-mail message:

- 1 On the Windows Live Inbox screen, tap **Menu > New**.

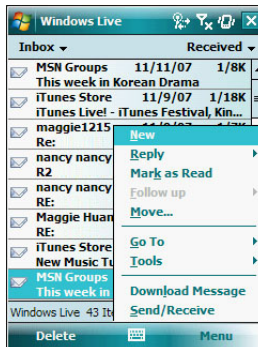

- 2 Enter the e-mail add of your intended recipients in the "To" box.
- 3 Enter the subject in the Subject line.
- 4 Compose your message.
- 5 Tap **Send** when you have finished the message.

Live Messenger



Live Messenger on your device is an instant messaging program that lets you:

- See who is online
- Send and receive instant messages
- Conduct instant message conversations with groups of contacts

Requirements to use Live Messenger

- For Windows Live Messenger Service, a Passport. If you have a Hotmail® or MSN account, you already have a Passport.
- Sign up for a Microsoft Passport account at <http://www.passport.com>. Get a free Microsoft Hotmail e-mail address at <http://www.hotmail.com>.
- For Exchange Instant Messaging Service, an Exchange account.
- To set up an Exchange account, see your network administrator.

To open Live Messenger:

- 1 Sign in to Windows Live.
- 2 On the Today screen, tap  and select **Messenger** .

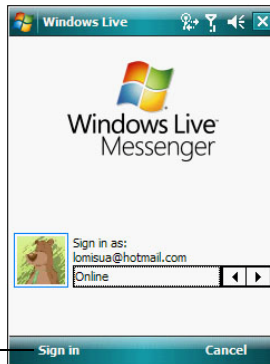

Tap to sign in. —

6 Using the Windows Mobile Programs

Windows Live

3 Tap **Sign In**.

If you already use Live or MSN Messenger on your computer, your contacts will show up on your device without being added again.

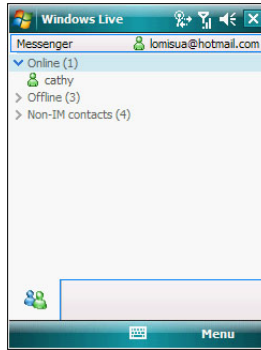

NOTE: To sign in after connecting to a wireless network, tap **Menu > Options > Messenger**, then follow the directions on the screen.

To work with contacts:

The Live Messenger screen shows all of your messenger contacts at a glance, divided into Online and Not Online categories. From this view, while connected, you can chat, send an e-mail, block the contact from chatting with you, or delete contacts from your list using the pop-up menu.

- To see others online without being seen, tap **Menu > Change Status > Appear Offline**.

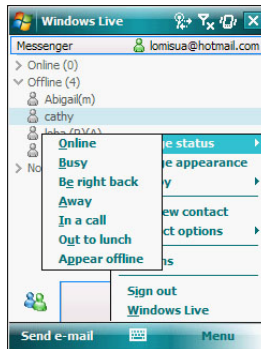

- If you block a contact, you appear offline but remain on the blocked contact list.
- To unblock a contact, tap and hold the contact, then tap **Unblock** on the pop-up menu.

To chat with contacts:

- 1 To open a chat window, tap a contact name.
- 2 Enter your message in the text entry area at the bottom of the screen.

- 3 Tap **Enter**.

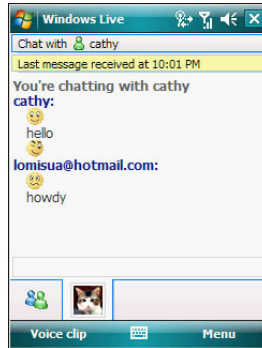

Tips when chatting with contacts

- To invite another contact to a multi-user chat, tap **Menu > Chat**, then tap the contact you want to invite.
- To return back to your chat window, tap **Menu > Chat**, then select the person with whom you were chatting.
- To see if the contact you are chatting with is responding, look for the message under the text entry area.

To sign out of your account:

- Tap **Sign Out**.

Live Sync

Windows Live Sync lets you synchronize Windows Live contacts, they will appear in your mobile device address book, allowing you to call, e-mail, or send instant messages to all your contacts more easily. You will also see your contact's online status, Spaces updates, and pictures in the address book. If you choose not to sync Windows Live contacts with your mobile device address book you will still be able to find your Windows Live contacts in Messenger.



NOTE: Make sure you create a connection to the internet before using Windows Live Sync.

To synchronize e-mail using Live Sync:

- 1 Sign in to Windows Live.

6 Using the Windows Mobile Programs

Windows Live

- 2 On the Today screen, tap  and select  **Sync**.

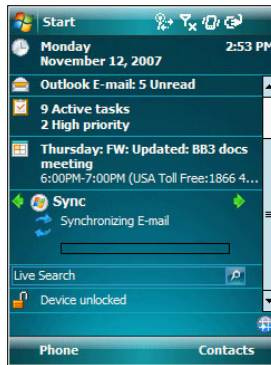

7 Using Phone

The phone function of your MC35 EDA boasts of standard cell phone features—such as mailbox and text messages—as well as several handy call features including Speed Dial, Caller ID, Conference Call, Call Forwarding, Call Waiting, Voice Mail and Text messages, Fixed Dialing, Call Barring, Call History, speakerphone, note taking, voice mail, and emergency number setting.

The Phone program is integrated with both Microsoft Contacts and Messaging. This means you can make a call and send e-mail/text messages from any of these three programs. This fully integrated functionality of Phone also makes sharing contact information between programs an easier task.

This chapter shows you how to install a SIM (Subscriber Identity Module) card on your device. It also describes basic phone operations and features, as well as ways of customizing the phone function based on your preferences.

- Phone setup
- Dialer screen
- Phone operation
- Making phone calls
- Phone features
- Phone profiles
- Phone preferences

Phone setup

Installing the SIM card

If you wish to use the phone function, you need to first install a valid SIM card.

A SIM card is a small printed circuit board that must be installed when signing on as a subscriber in a GSM-based mobile phone like your MC35. It contains subscriber details, security information and memory for a personal directory of numbers.

To install the SIM card:

- 1 If the device is switched on:
 - (a) Press the **Power** button  to turn off the device.
 - (b) Wait for five seconds to allow the device to completely enter sleep mode.
- 2 Remove the battery pack. See “To uninstall the battery pack” on page 2 for instructions.
- 3 With the rear panel facing you, slide the SIM card holder to the right.
- 4 Lift the holder halfway from the recess area.

7 Using Phone

Phone setup

- 5 Insert the SIM card into the SIM card holder.

Note the proper position of the SIM card—the card connector (i.e., gold area) should be facing downward with the beveled corner fitting the lower-left corner of the recess area.

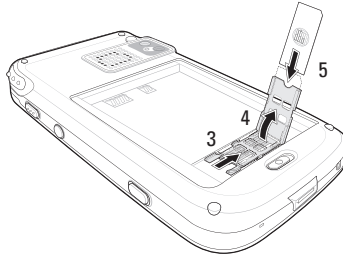

- 6 Press the SIM card holder down.

- 7 Slide the SIM card holder to the left to lock it into place.

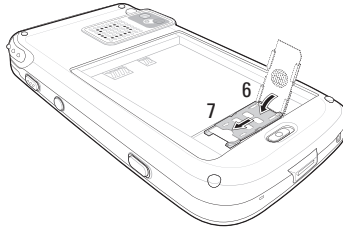

- 8 Reinstall the battery pack. See "To install the battery pack" on page 2 for instructions.

The default settings for your device are programmed on the assumption that you'll be using the phone function once you've properly installed a SIM card (and in some cases, entered a PIN), you can then proceed to establishing a connection to your mobile service provider's network.

NOTE: If you're not going to install a SIM card on your device, keep the Phone program closed or turn the program off using Wireless Manager to minimize power consumption.

Entering your PIN

After installing the SIM card you'll be able to activate your mobile service connection. In most cases, SIM cards are preset with a PIN (Personal Identity Number), provided by your mobile service provider.

To enter your PIN:

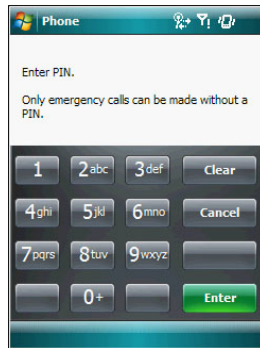

- 1 Tap  > **Phone** .
- 2 On the Dialer screen, enter the preset PIN from your mobile phone service provider.



- 3 Tap **Enter**.

If you consecutively enter a wrong PIN for three times, the SIM card is blocked. If that happens, you can unblock it with the PIN Unblocking Key (PUK code) also provided by your mobile phone service provider.











Dialer screen

To launch the Dialer screen, tap  > **Phone**  or press the **Send** button .



Dialer buttons

The list below shows the actions of the Dialer screen buttons.

Icon	Description
	Tap to erase the number you entered.
	Tap to view the Speed Dial list.
	Tap to see all received, made, and missed calls.
	Tap to call the displayed number.
	Tap to enable speakerphone mode.
	Tap to view Contacts.
	Tap to mute a call.
	Tap to hold a call.
	Tap to end a call.
	Tap during a call to create a note or recording for a particular call.

Phone status icons

The list below shows the Phone-related status icons.

Icon	Name	Description
	Network search	Indicates that the device is attempting to establish mobile service connection.
	No network	Indicates that the device is not able to establish mobile service connection.
	Phone off	Indicates that the phone is off.
	In network service	Indicates that the phone is connected to a network.
	Signal status	The number of bars indicates the strength of your connection signal. As the strength of the signal diminishes the number of bars in the icon diminishes, with no bars indicating no signal.
	Active call	Indicates that a call is being made or there is an incoming call.
	Speakerphone	Indicates that the speakerphone mode is enabled. See "Using the speakerphone" on page 109 for more information on how to activate the speakerphone.
	Missed call	Indicates that you have a missed call.
	Unread message	Indicates that you have unread text or e-mail message(s), as well as voice mail notification(s).

Phone operation

Turning the phone function on and off

If you have turned the phone function off, removed and then reinstalled the SIM card, the connection to your mobile service provider's network is not automatically enabled. You have the option to just use the device's EDA features or you can re-establish the mobile service connection.

IMPORTANT: In many countries it is required by law to turn off cell phones when boarding commercial flights. Turning off your MC35 does not turn off the device's phone function; you must use the Wireless Manager to turn off the phone.

7 Using Phone *Phone operation*

To turn on the phone function:

- 1 Launch the Wireless Manager application:

- On the Today screen, tap **Wireless Manager** .

Tap to launch the
Wireless Manager.

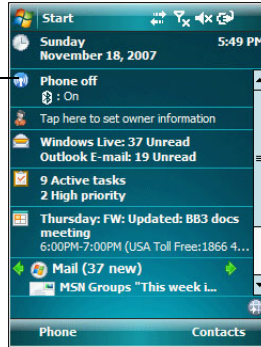



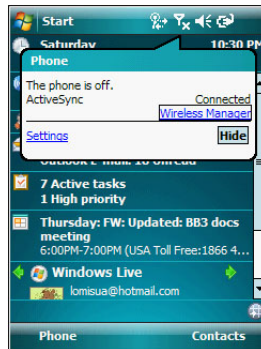

-or-

- On the Today screen, tap the **signal** icon  on the upper right corner of the screen, then from the Phone callout, tap **Wireless Manager**.

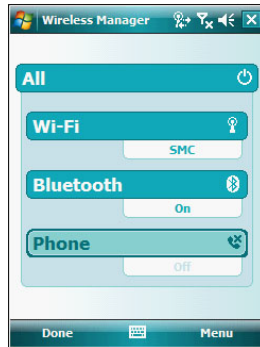



- 2 On the Wireless Manager screen, tap **Phone** to turn on phone function.



The signal icon  changes indicating the MC35 is searching for a mobile connection. This may take a few seconds. The signal icon  changes to , and to  once a mobile connection is established.

To turn off the phone function:

- 1 Launch the Wireless Manager application.
 - On the Today screen, tap **Wireless Manager** .
 - or-
 - On the Today screen, tap the **signal icon**  and select **Wireless Manager**.
- 2 On the Wireless Manager screen, tap **Phone** to turn off phone function.

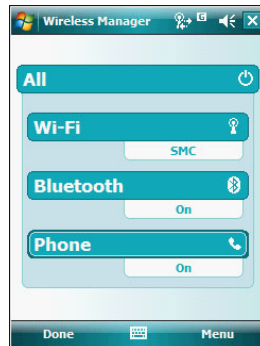

Erasing number input

If you entered a wrong phone number when dialing, you can either backspace to erase individual digits or you can delete the entire phone number

- Tap  to backspace over digits.
- Press the Backspace key on the keypad.



Answering a call

- On the Call Notification callout, tap **Answer** or press the **Send**  button.

Rejecting a call

- On the Call Notification callout, tap **Ignore** or press the **End**  button.
Depending on your mobile service subscription, either a busy tone is sent out, or the call is forwarded to your voice mailbox.

Ending a call



- Tap **End**  or press the **End**  button.

Adjusting the phone volume

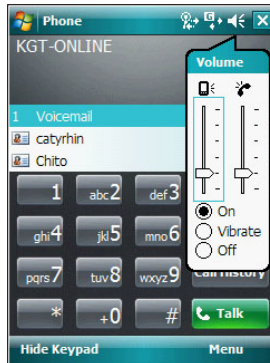
To adjust the phone volume, you must do so during a call. If you adjust the volume at another time it only affects the level of the system sounds (i.e., ring and notification alerts, .wmv/MP3 playback).





To adjust the phone conversation volume:

- 1 Tap  on the navigation bar or press the volume key down to bring up the Volume drop-down box.
- 2 Drag the  slider to adjust the phone volume.



Using the speakerphone

To attend to phone calls, attach the single earbud headset or activate the speakerphone mode. The speakerphone function allows you to talk hands-free and/or let other people listen to the caller.

To enable speakerphone mode:

- Press and hold the **Send**  button or tap the **Speaker On**  screen button until the speakerphone turns on as indicated by the appearance of the **Speakerphone** icon  on the navigation bar.

To disable speakerphone mode:

- Press and hold the **Send**  button or tap the **Speaker On**  screen button again until the **Speakerphone** icon  disappears from the navigation bar.

Muting a call

During a call you can mute the microphone so that the person with whom you are speaking cannot hear you, but you can still hear him or her. This is useful if, for example, you do not want the other person to hear a conversation or background noise on your side of the call.

To mute a call:

- During a call, tap **Mute**  to toggle the mute function on and off.

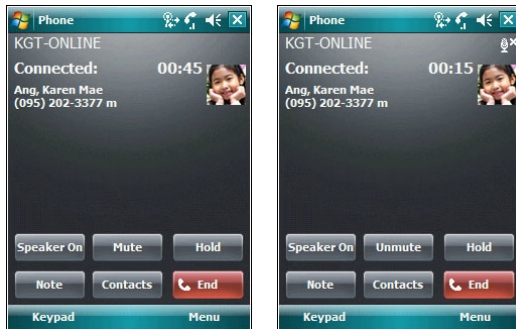

The mute icon  is displayed on the Dialer screen's entry area to indicate that the mute function is enabled.



Making phone calls

The integrated nature of your device's phone function lets you make calls in a variety of ways across different applications. You can make a call by:

- Manually entering a phone number using the Dialer keypad.
- Accessing numbers using Speed Dial, Call History, Microsoft Contacts or SIM Manager.

Once a call has been initiated the signal icon  changes to  indicating an active call.

To make a call using dialer:

- 1 On the **Dialer** keypad, tap the phone number you want to call.
- 2 Tap **Talk**  or press the **Send**  button.





7 Using Phone

Phone operation

To make a call using Microsoft Contacts:

There are several ways to make a call in Contacts. In this section, only the method using the hardware buttons is described. See "Calling a contact" on page 69 for instructions on other methods.

- 1 Tap  > **Contacts** .

Contacts opens to the contact list.

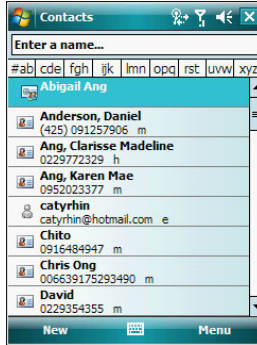

- 2 Type a name or number, or move the joystick up or down to scroll through the contact list and select the contact you want to call.
- 3 Press the **Send**  button twice—once to launch Phone and another to make the call. The call will be made to that contact's priority number.

To make a call using Speed Dial:

Speed Dial is a list you create for numbers you call regularly. Only numbers stored in Microsoft Contacts can be added to this list.



You can make a call in two ways:

- By memorizing a phone number's position in the Speed Dial list, you can dial the number by entering its location number.



In the picture above, Clarisse Madeline Ang is at position 2. To dial her number, tap and hold 2 on the Dialer keypad until you hear a beep.

If a number holds a position of 10 or higher tap the first number, and then tap and hold the second to dial. For instance, to call the number in position 12, tap 1 then tap and hold 2.

- Alternatively, if you don't remember the position of a number in the Speed Dial list follow the steps below:
 - (a) Tap **Speed Dial** .
 - (b) On the **Speed Dial** screen, press the joystick to go through the list to find the number you want to call.
 - (c) Once the number is selected, you can either press the joystick or the **Send**  button to initiate the call.

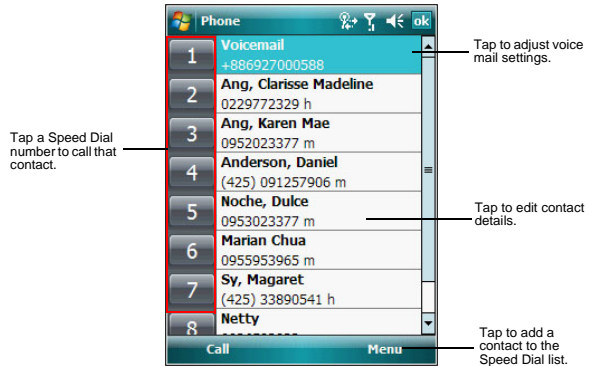

To make a call using Call History:

Call History is a record of all incoming, outgoing, and missed calls.

- 1 Tap **Call History** .
- 2 Find the number you want to call. You can select a call category—All Calls, Missed, Outgoing, Incoming, and By Caller—by tapping the pick list in the top-left corner of the screen.
- 3 Once the number has been selected press the joystick or the **Send** button to make the call.

Tap the **category** icon on the left of the selected number.

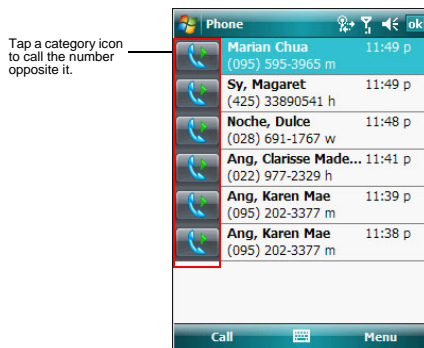



7 Using Phone

Phone operation

To make a call using SIM Manager:

SIM Manager is a program you can use to view and manage the contents of your SIM card.

- 1 Tap  > **Settings** .
- 2 On the **System** tab, tap **SIM Manager** .
Wait for the SIM card contents to load.

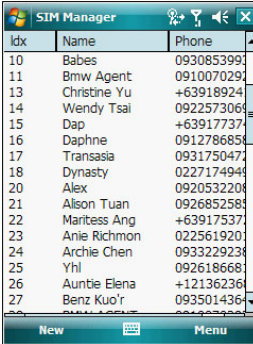



Idx	Name	Phone
10	Babes	0930853991
11	Bmw Agent	0910070291
13	Christine Yu	+63918924
14	Wendy Tsai	0922573069
15	Dap	+63917737
16	Daphne	0912786858
17	Transasia	0931750471
18	Dynasty	0227174949
20	Alex	0920532208
21	Alson Tuan	0926852588
22	Maritess Ang	+63917537
23	Anie Richmon	0225619201
24	Archie Chen	0933229238
25	Yhl	0926186688
26	Aunbie Elena	+12136236
27	Benz Kuo'r	0935014368

- 3 Scroll to the SIM contact you want to call and perform any of the following:
 - Press the joystick.
 - Press the **Send**  button.
 - Tap and hold the SIM contact, then select Call from the pop-up menu.

To make a call from a Bluetooth-enabled headset:

You can use a Bluetooth-enabled headset with your device when you create a partnership between your device and the headset.

- 1 Make sure that the two devices are turned on, discoverable, and within close range.
- 2 Tap  > **Settings** .
- 3 On the **Connections** tab, tap **Bluetooth** .
- 4 On the **Devices** tab, tap **Add new device**.

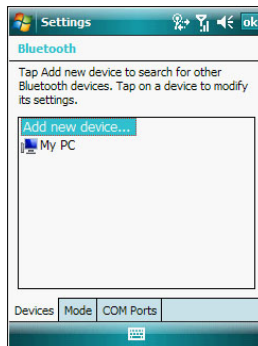



Your device will search for other Bluetooth devices and displays them in the device list.

- 5 Tap the name of the Bluetooth-enabled hands-free device in the list, then tap **Next**.

- 6 If you want to use a passcode, enter the alphanumeric passcode for the Bluetooth-enabled hands-free device, then tap **Next**.
You can find the passcode in the manufacturer's documentation for your hands-free device.
- 7 Tap **Finish**.
- 8 Select the check box for the Hands Free service, and tap **Finish**.
Once the headset is paired with the device, it acts as your device's microphone and speakers. You can use Gain Adjust, a noise reduction software, to reduce background noise to provide better sound quality during a call. See "Gain Adjust" on page 158 for more information.

To make an International call:

For making a call to an overseas number that is not stored either in your SIM card or on your device, follow the steps below.

- 1 Tap and hold the Backlight/0 key until the plus (+) sign appears.
This sign replaces the international number prefix "00".
- 2 Enter the full phone number you want to dial.
It includes the country code, area code (without the leading zero), and phone number.
- 3 Tap **Talk**  or press the **Send**  button.



Making an emergency call

MC35 supports the international emergency number 112, and for US/Canada residents, the emergency number 911 as well. You can call these numbers for emergency police, fire, and medical assistance.

NOTE: In some cases, additional local emergency numbers may be provided by your mobile phone service provider.

Generally, you can make a call to these emergency numbers, with or without a SIM card installed on your device, as long as a mobile phone service network is available in your area. However, some mobile phone service providers may require that a SIM card is inserted, and in some cases that the PIN has been entered as well, before an emergency call can be made. Contact your mobile service provider for the requirements applicable to your mobile subscription.

To make an emergency call:

- 1 Dial the emergency number by using Dialer.
 - For international emergency calls, dial 112.
 - For US/Canada emergency calls, dial 911.
- 2 Tap **Talk**  or press the **Send**  button.

Phone features

Flexibility is a hallmark of your device's phone function. This is best exemplified in such features as Call Notification, Call Hold and Conference Call, which allows you to attend to more than one call simultaneously—all with a simple tap of your stylus.

Variety is another hallmark of your device's phone function. This is implemented in such range of features as Call Notes, text/e-mail messaging, Voice Mail, and Contacts Integration.

NOTE: The availability of some of the phone features described in this section may depend on your mobile service subscription. Contact your mobile service provider for information.

Call notification and identification

The Call Notification feature lets you know if another person is trying to call you when you are talking on the phone. When this happens the following callout appears.



The Caller Identification feature matches the incoming call number with those stored in Contacts so you know who is calling you.

Call hold

After being notified of an incoming call while already on the phone, you can choose to reject a call by tapping the Ignore button on the Call Notification callout, or you can use the Call hold feature to attend to both calls.

To put a call on hold:

- On the **Call Notification** callout, tap **Answer** to take the incoming call and put the original one on hold.

To swap between calls:

- To shift between two callers tap **Menu > Hold**.

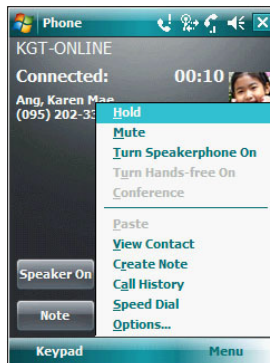

Conference call

With the Conference Call feature you can create a conversation line between several callers. You can either, put a call on hold, then dial another number and wait for it to be picked up; or accept an incoming call when you already have one in progress.

To set up a conference call:

- During a call with two active numbers, tap **Menu > Conference**.
If the conference connection is successful the word "Conference" will appear in the input area of the Dialer screen.

To add additional people to a conference call:

You can connect up to six (6) callers at a time in a conference call.

- 1 During an active conference call, tap **Menu > Hold**.
- 2 Key in the new number.
- 3 Tap **Resume** to return and continue with the conference call.
- 4 Repeat steps 1-3 to add more people in the conference call.

Call notes

The Call Notes feature allows you to create a written or recorded note during a call. The call note will be saved as an attachment to your call as viewed in Call History.

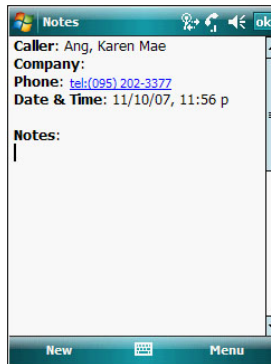

To create a call note:

- 1 During an active call, tap **Note** .
- 2 On the **Notes** screen, use any of the input methods to compose your call note.



- 3 After you finished your call note, tap **ok**.

To add a recording to a call note:

- 1 During an active call, tap **Note** .
- 2 On the **Notes** screen, tap **Menu > View Recording Toolbar**.
- 3 Position your device's built-in microphone near your mouth or other source of sound.
- 4 On the Recording toolbar, tap .
- 5 Tap  to stop recording.

7 Using Phone

Phone features

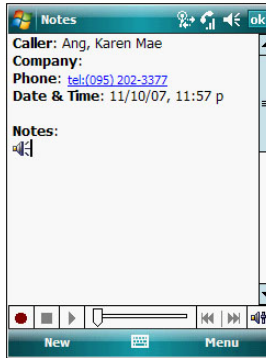

The new recording appears as an embedded icon.



6 Tap **ok**.

To view a call note:

You can view call notes either from the Call History screen or from the Notes program.

- On the **Call History** screen:
 - (a) Tap **Call History** .
 - (b) Select a log item marked with this .
 - (c) Tap and hold the selected log item, then tap **View Note** from the pop-up menu.

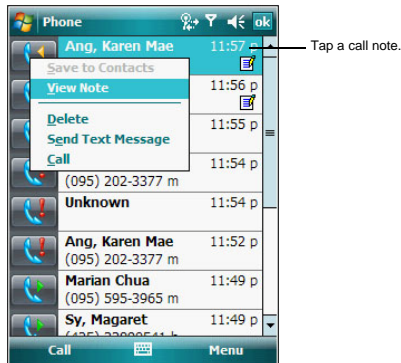

- On the **Notes** screen:
Tap the call note from the list.
A call note's label corresponds to the name or phone number of the related contact.

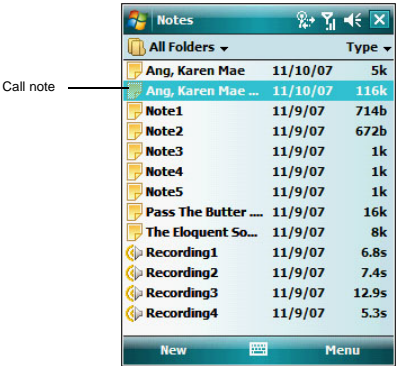

Text messaging service

Just like a regular mobile phone, you can send and receive text messages using your device. Your account is automatically setup in Inbox when you activated your mobile service subscription.

To view a text message:

You can view a text message whether the phone function is on or off.

- When the phone function is on, you can view a text message from its notification callout:
Tap the **text message notification** icon  on the navigation bar to display the message.





7 Using Phone

Phone features

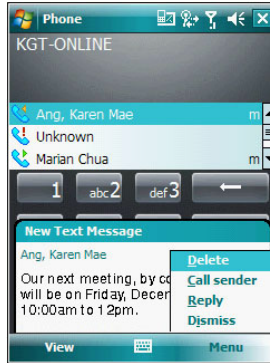
The Caller Identification feature matches incoming text message numbers with those stored in Contacts so you know who is sending you a message. Furthermore, the "New Text Message" callout gives you the option to call the sender or save, dismiss, or delete the message.



- When the phone function is off, you can still view received text message in Messaging:
 - (a) Perform one of the following:
 - Tap  > **Messaging**  > **Text Messages**.

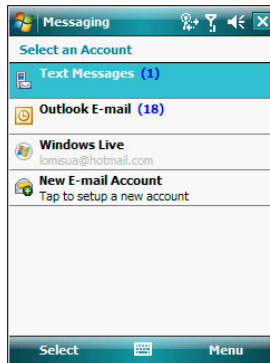

-or-

- On the Today screen, tap **Text Messages**.

Tap Text Messages.

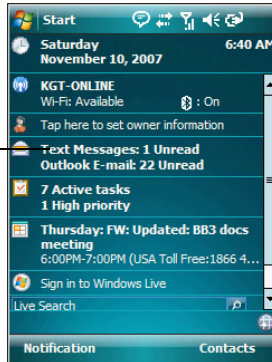

- (b) In the message list, tap a text message.

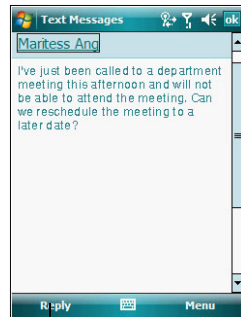
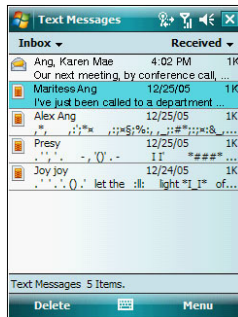

Tap to reply the message.

NOTE: If the phone function is turned off and you tried to call the sender, send a reply, or forward the message, you will be prompted to turn the phone function on.

7 Using Phone

Phone features

To create a text message:

- 1 On the **Dialer** screen, select a contact name that you want to send a message to.
- 2 Tap **Menu > Send Text Message**.



- 3 Compose your message.



The auto-correct feature automatically fixes common spelling errors as you type so your messages are more accurate.

The character counter lets you see and control the size of the message as you compose.

If you want to know if your text message was received, tap **Menu > Message Options**, then select the Request SMS text message delivery notification check box.

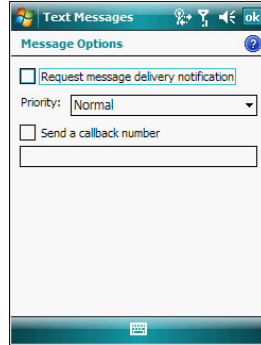

- 4 Tap **Send** when you've finished the message.

If the phone function is turned on, your text message will be sent out. If it's off, you will be prompted to turn on the phone function. If you do so, the message will be sent out; otherwise when you tap **ok**, the message will be saved in the Drafts folder and you can send it out later.

Voice mail

With the voice mail service you need not miss a message when you miss a call. Unattended calls (i.e., no answer, phone function is turned off or is out of network service) or a busy line will automatically forward callers to your voice mailbox where they can leave their messages.

When you insert your SIM card into your device, it will automatically detect and set as default the voice mailbox number provided by your mobile service provider. By default, the first Speed Dial location is assigned to your voice mailbox.

To retrieve your voice mails:

- Tap and hold the  button on the Dialer keypad.
Your voice mail retrieval number is automatically dialed.

7 Using Phone

Phone features

- Tap the **New Text Message Notification** icon  informing you of the new voice mail, then tap **Menu > Call sender** from the “New Text message” callout.

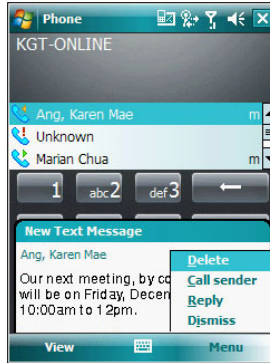

Contacts integration

Your device's phone function is integrated with other applications making it easy for you to share contacts—phone numbers—between programs. Listed below are the places where contacts can be stored on your device:

- **Microsoft Contacts**
Your contact list contains phone numbers that you can use in Phone.
- **Your SIM card**
You interchange your SIM card between your MC35 and another device; while using the other device you can create new contacts on the SIM card.
- **Call History**
New contact numbers can be found in incoming or missed calls.

Sharing contacts in Microsoft Contacts

Below are several advantages for exporting contact information to Microsoft Contacts:

- As a backup in case you lose your SIM card while using it with another device.
- If you are using your SIM with another device, you may need the numbers stored in Microsoft Contacts.
- Exporting phone numbers to Microsoft Contacts allows you to create a more detailed record.

To add contacts to Microsoft Contacts:

You can choose to create new contacts or add contacts from SIM Contacts or from Call History.

- See "To create a contact" on page 68 for more information on creating new contacts.
- See "Sharing contacts in call history" on page 109 for more information on adding Call History items.
- See "Sharing contacts in SIM Contacts" on page 109 for more information on adding SIM contacts.

To export contacts from Microsoft Contacts:

- 1 Perform one of the following:
 - Tap and hold a contact to display the pop-up menu.
 - Tap a contact to select it, then tap **Menu**.If you do not select a contact, the first entry on the list will be exported.
- 2 Select the location where to export the contact.

To export a contact to Speed Dial:

- 1 Tap a contact to select it, then tap **Menu > Add to Speed Dial**.

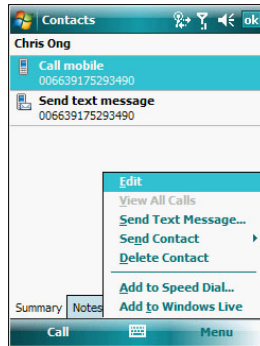

- 2 In the next screen add the contact details.
- 3 Select a location. You can either:
 - Accept the default location which is the first available position in the Speed Dial list.
 - Use the up and down arrows in the **Location** field to scroll and select the desired location. If you want to put a number in a position that is already occupied, the new number will overwrite the number already there.
- 4 Tap **ok**.

Sharing contacts in SIM Contacts

SIM Contacts enable you to manage all contacts stored in your SIM card with the option to export this information to Microsoft Contacts.

To export SIM contacts:

You can choose to export individual or all SIM Manager contacts to Microsoft Contacts.

Sharing contacts in call history

Call History is a record of all incoming, outgoing, and missed calls. You have the option to export new numbers under the Incoming and Missed categories to Microsoft Contacts.

To export Call History entries to Microsoft Contacts:

- 1 On the **Dialer** screen, tap **Call History**.
The Incoming or Missed categories appear.
- 2 Tap and hold the number you want to export.

7 Using Phone

Phone features

- 3 In the pop-up menu that appears select **Save to Contacts**.

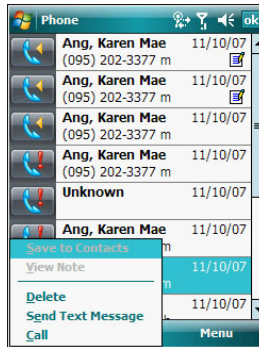

- 4 On the Contact screen add additional contact details.

- 5 Tap **ok** or press the joystick.

The call details in the **Call History** for the transferred number will change to display the contact name specified.

Call History

All calls made on your device are recorded in Call History. It provides the time and duration of all incoming, outgoing, and missed calls, and a summary of total calls. You can refer to it to access any notes taken during a call. You can also set a limit on the number of entries or delete them as necessary to save memory space.

To view Call History:

- On the Dialer screen, tap **Call History**.

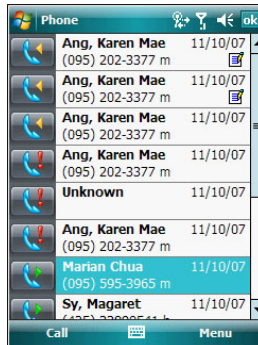

To change the Call History view:

You can limit the number of entries that appear on the Call History list according to specific criteria, such as All Calls, Missed, Outgoing, Incoming, or By Caller.

- 1 On the **Dialer** screen, tap **Call History**.
- 2 Tap **Menu > Filter**, then select a different view. For example, you can view only missed or incoming calls.

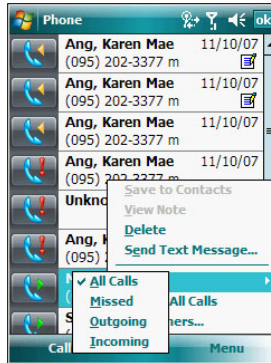

The Call History list can be filtered according to the following criteria.

Category	Description
All Calls	Shows all calls made to and from your device in a chronological order.
Missed	Shows calls made to your device that were not answered.
Outgoing	Shows all calls made from your device.
Incoming	Shows all calls made to your device.

7 Using Phone

Phone features

Call details

Call History allows you to check the date and time a call was made, as well as the duration.

To view call details:

- Find the call you are interested in, then tap it once.

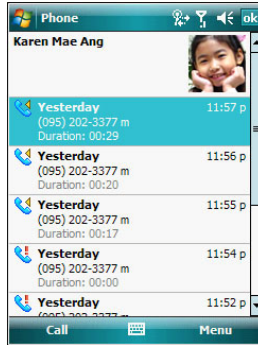

Call history limit

To minimize the memory space occupied by the Call History items, you can set a limit for the number of entries retained after a specific period of time. You can also delete items that you no longer need.

To set the Call History limit:

- 1 On the command bar, tap **Menu > Call Timers**.

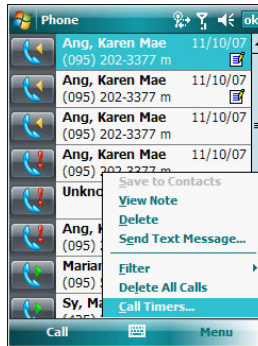

- 2 On the Call Timers screen, tap the "Delete call history items older than" pick list, then, tap a time period option.

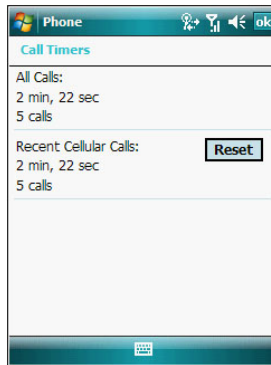

- 3 Tap **ok**.

To delete individual Call History entries:

- Tap and hold the entry you want to delete, then from the pop-up menu, select **Delete**.



To delete all Call History entries:

- From the command bar, tap **Menu > Delete All Calls**.

Phone profiles

Your device supports five types of preset profiles. These preset profiles allow you to personalize the ring tone, image, and profile expiration time settings of your device, and to activate a profile for different events and environments.

To activate a pre-defined phone profile:

- 1 Tap  > **Settings** .
- 2 On the System tab, tap **Phone Profiles** .
- 3 Select a profile setting.
- 4 Tap **Menu > Active**.

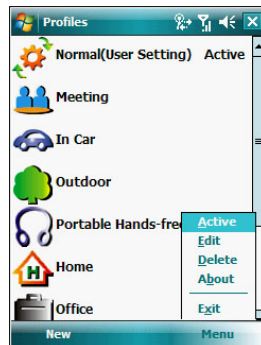

7 Using Phone

Phone profiles

To create a new phone profile:

- 1 Tap **Settings**.
- 2 On the **System** tab, tap **Phone Profiles**.
- 3 Tap **New** > **Yes**.

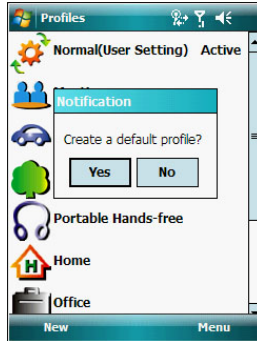

- 4 Define the phone profile settings.
- 5 Tap **OK** > **ok**.

To change a phone profile setting:

- 1 Tap a profile setting that you want to change.
- 2 Tap **Menu** > **Edit**.

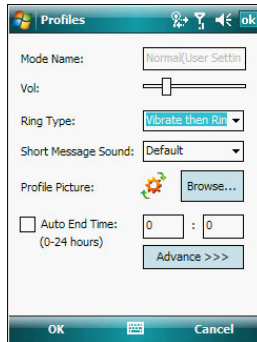

- 3 Enter a profile name.
- 4 Set the ring volume for incoming voice calls and messages by pressing the **Volume** key up or down.
- 5 Select a ringing option for incoming voice calls in the **Ring Type** list.
- 6 Select a ringing option for incoming messages; tap the **Short Message Sound** list.
- 7 Select a picture to add to your profile by tapping **Browse**.
- 8 Set the duration of the alerting signal prior to an incoming voice call or SMS message.
- 9 Tap **Advance**.
- 10 On the **Incoming**, **Reminders**, and **Message** tab, define settings for an incoming voice call or SMS message.
- 11 Tap **Save** > **OK**.
- 12 Tap **OK** > **Yes**.



To delete a phone profile:

- 1 Tap a profile setting.
- 2 Tap **Menu > Delete**.
- 3 Tap **Yes > OK**.

To activate the HAC profile:

MC35 is compliant with the FCC HAC (Hearing Aid Compatibility) requirements. When some wireless devices are used near hearing devices (such as hearing aids and cochlear implants), a buzzing, humming, or whining noise may be detected. Some hearing devices may be more immune than others to this interference, and wireless devices also vary in the amount of interferences they generate. MC35 has a predefined HAC profile that optimizes the audio performance for some hearing aids.

NOTE: Some hearing aids may be more immune than others are to interference. Consult your hearing health-care professional to determine the rating of your hearing aid and whether the hearing aid will work with this device.

- 1 Tap  > **Settings** .
- 2 On the **System** tab, tap **Phone Profiles** .
- 3 Tap **HAC**.
- 4 Tap **Menu > Active**.

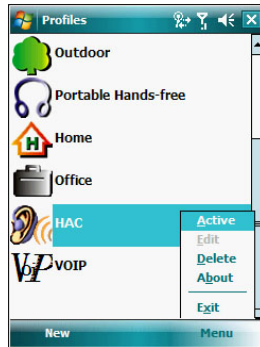

Phone preferences

You can configure most features of the phone function to suit your preferences. You do this by accessing the Phone option under Settings.

To access Phone settings:

- On the **Dialer** screen, tap **Menu > Options**.
- or -

From any other screen, tap  > **Settings**  > **Personal** tab > **Phone** .

The **Phone Settings** screen has five tabs—Phone, Services, Network, Band, and PPP Auth. Refer to the following sections for the configuration options available for each tab.

Phone tab

Configure sound and security settings in this tab.

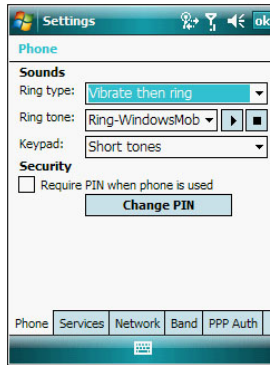

NOTE: Before proceeding with the configuration, make sure Phone  is turned on.

To configure ring type, ring tone, and keypad sounds

- 1 Turn on Phone .
- 2 In the **Sounds** option, tap the pick list for each field, then select your choice from the drop-down list.

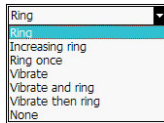

Ring Type

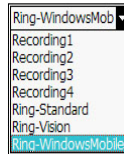

Ring Tone



Keypad Sounds

To listen to a ring tone:

- Select the ring tone file you want to play, then tap the **Play** button. To stop ring tone playback, tap the **Stop** button.

To customize the ring tone options:

To have a more personalized batch of ring tones to choose from, you can download additional sound files to your device. File formats supported include .wav, .wma, .mp3, and .mid.

- 1 To add more ring tone options to your device, you can:
 - Synchronize sound files from your computer using ActiveSync.
 - Download sound files from a network using a GPRS or Wi-Fi connection
 - Received sound files from other IR- or Bluetooth enabled devices.

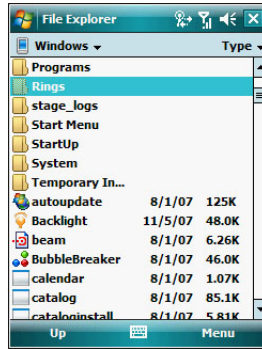

- After receiving the sound files in your device, use **File Explorer**  to make sure that they are located in the My Device | Windows | Rings folder. Only then will they be listed as ring tone options.



- Create customized ring tone options by creating stand-alone recordings in Notes. These recordings are automatically copied to the **My Device | Windows | Rings** folder. See "To set a voice recording as ringtone" on page 30 for related instructions.

To associate a ring tone with a contact:

Rings tones can be set to be triggered by a contact to let you know at once when an incoming call is from that contact without looking at the display.

- Tap  > **Contacts** .
- Tap a contact in the contact list (or select it using the joystick), a summary screen displays. This is referred to as a contact card.
- Tap **Menu > Edit**.
- On the **Ring tone** list, select a voice recording.

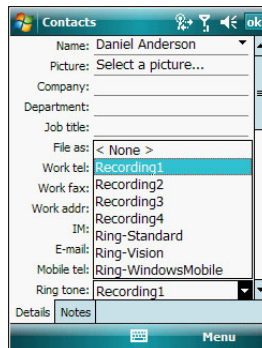

- Tap **ok**.

Configuring your PIN

Under the Security options, you can change your PIN and have it enabled or disabled.

To enable your PIN:

- Select the "Require PIN when phone is used" check box.

7 Using Phone

Phone preferences

To disable your PIN:

- Deselect the "Require PIN when phone is used" check box.

To change your PIN:

- 1 Tap the **Change Pin** button. The Dialer screen displays.
- 2 Enter the old PIN, input a new one, then retype it for confirmation.

Services tab

Configure the different phone services in this tab—Call Barring, Caller ID, Call Forwarding, Call Waiting, Voice Mail and Text Messages, and Fixed Dialing.

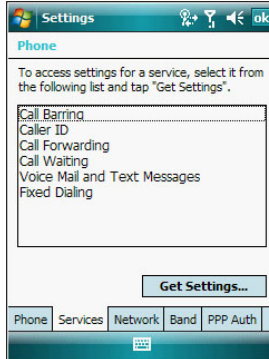

NOTE: The availability of some of the phone services described in this section may depend on your mobile service subscription. Contact your mobile service provider for information.

Call barring

You have the option to block calls in specific situations.

To enable or disable call barring:

- 1 On the **services** list, tap **Call Barring**.
- 2 Tap the **Get Settings** button (retrieving settings may take a few minutes).

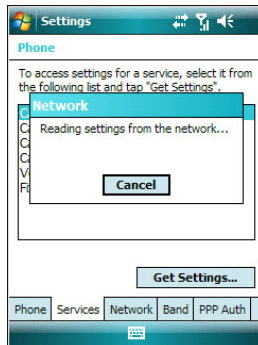

- 3 On the next screen, define the call barring settings.
 - Block incoming calls
 - All calls - to prevent any calls from coming through
 - When roaming - to block incoming calls when in phone service is in roaming status
 - Off - to accept all incoming calls
 - Block outgoing calls
 - All calls - to prevent any calls from being made from your device
 - International - to block outgoing international calls
 - International except to home country - to block all outgoing international calls other than those being made to the set home country
 - Off - to disable call barring for all outgoing calls

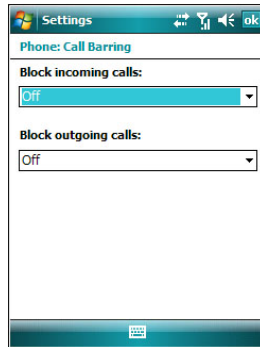

- 4 Tap **ok**.

To confirm the call barring function on your device is activated, repeat step 1 and 2. The Settings screen displays with the new setting.

Caller ID

When this service is enabled and you make a call, your phone number will be displayed on the phone screen of the person you're calling.

To enable or disable Caller ID:

- 1 On the [services](#) list, tap **Caller ID**.
- 2 Tap the **Get Settings** button (retrieving settings may take a few minutes).
- 3 On the next screen, define the caller ID settings.
 - Everyone - to enable Caller ID
 - No one - to disable Caller ID

7 Using Phone

Phone preferences

- Only to contacts - to enable caller ID for selected phone numbers only

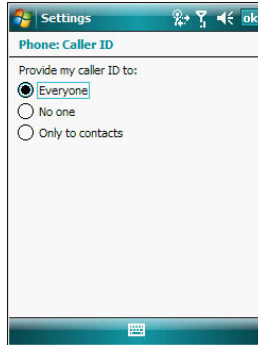

- 4 Tap **ok**.

To confirm the caller ID function on your device is activated, repeat step 1 and 2. The Settings screen displays with the new setting.

Call forwarding

This service allows you to forward incoming calls to another phone number. You can choose to forward all calls to the same number or specify a number based on the following conditions:

- Unavailable - the phone function is turned off or is out of network service
- Busy - when you are attending to a phone call
- No answer - when you are not answering your phone calls

To enable or disable call forwarding:

- 1 On the services list, tap **Call Forwarding**.
- 2 Tap the **Get Settings** button (retrieving settings may take a few minutes).
- 3 On the next screen, follow these steps to enable or disable call forwarding:
 - To enable call forwarding:
 - Tap the "Forward all incoming phone calls" check box, then specify the call forward phone number on the "To" field.
 - or -
 - To forward incoming calls to a different number based on the following conditions, then specify the call forward phone number on the box opposite it:
 - No answer - forward calls to a specific phone number when you can't answer your phone
 - Unavailable - forward calls to a specific phone number when the phone is turned off or you are unreachable
 - Busy - forward calls to specific phone number when the line is busy

- To disable call forwarding, deselect all the check boxes.

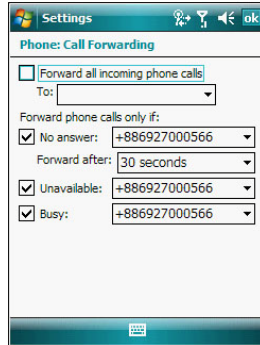

4. Tap **ok**.

To confirm the call forwarding function on your device is activated, repeat step 1 and 2. The Settings screen displays with the new setting.

Call waiting

This service allows you to receive another call during an active call.

To enable or disable call waiting:

- 1 On the services list, tap **Call Waiting**.
- 2 Tap the **Get Settings** button (retrieving settings may take a few minutes).
- 3 In the next screen, define the call waiting settings.
 - Notify me - to enable call waiting, or
 - Do not notify me - to disable call waiting

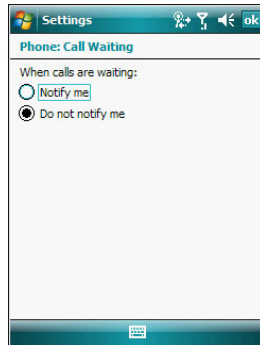

4 Tap **ok**.

To confirm the call waiting function on your device is activated, repeat step 1 and 2. The Settings screen displays with the new setting.

7 Using Phone

Phone preferences

Voice mail and text messages

By default your device will automatically detect and set the voice mail and text messages access numbers provided by your mobile service provider. You can view these numbers for your reference.

To view voice mail and text messages numbers:

- 1 On the [services](#) list, tap **Voice Mail and Text Messages**.
- 2 Tap the **Get Settings** button (retrieving settings may take a few minutes).
- 3 Enter the voice mail or text message phone number.

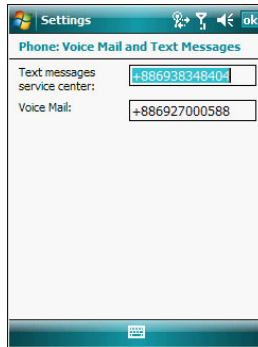

- 4 Tap **ok**.
To confirm the voice mail and text messages function on your device is activated, repeat step 1 and 2. The Settings screen displays with the new setting.

Fixed dialing

This service allows you to set predefined numbers or prefixes that you would like to call.

To create fixed number entries:

- 1 On the services list, tap **Fixed Dialing**.
- 2 Tap the **Get Settings** button (retrieving settings may take a few minutes).

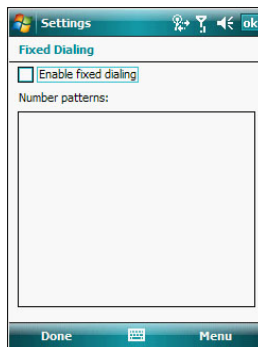

- 3 Tap the "Enable fixed dialing" check box, then tap **Done**.
- 4 To add a number to the list, tap **Menu > Add**.
- 5 Enter the phone number or area code you want to be restricted, then tap **Done**.
- 6 Repeat steps 4 and 5 to add more numbers, then tap **Done**.

- 7 Enter the unblock (PUK2) code.
- 8 Enter the PIN2, then tap **Done**.
- 9 Tap **ok**.

To confirm the fixed dialing function on your device is activated, repeat step 1 and 2. The Settings screen displays with the new setting.

To edit entries:

- 1 On the services list, tap **Fixed Dialing**.
- 2 Tap the **Get Settings** button (retrieving settings may take a few minutes).
- 3 Select the number pattern, then tap **Menu**.
- 4 Tap **Edit**, then enter PIN2 and tap **Done**.
- 5 Enter the new number, name, and position, then tap **Done**.

Network tab

This tab allows you to configure settings related to mobile service networks. The currently activated network is indicated on the first line of this tab.

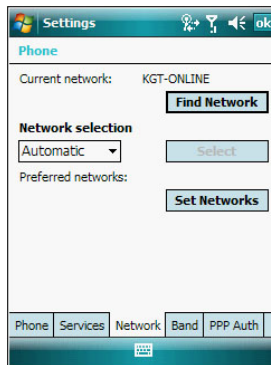

To find a network:

Do this when the network status is currently out of network service and you want to conduct a search.

- Tap the **Find Network** button (search process may take a few minutes).

To select a network:

Set the mode for conducting a network search.

- In the Network selection drop-down list, tap either **Automatic** or **Manual**. Retrieving network settings may take a few minutes if you select **Manual**.

7 Using Phone

Phone preferences

To set preferred networks:

If there are many mobile phone service providers available in your area, you can configure this function to select your preferred ones and set its priority level.

- 1 Tap the **Set Networks** button (search process may take a few minutes).

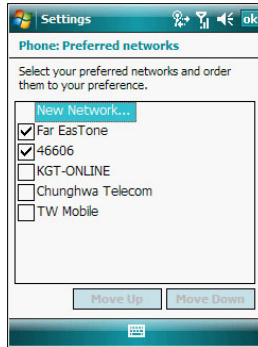

- 2 To include a listed network as a preferred network, tap the check box opposite it.
- 3 To set the priority level, tap a preferred network, then tap the **Move Up** or **Move Down** buttons.
- 4 Tap **ok**.

Band tab

MC35 operates on the GSM 850/900/1800/1900 bands. Use the Band tab to select a GSM band for your device to operate on.

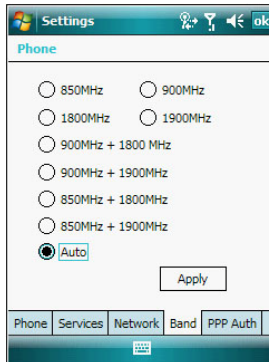

To set your device's roam mode:

- 1 On the **Band** tab, select a GSM band.
- 2 Tap **Apply**.

PPP Auth tab

The PPP Auth tab provides option for setting up PPP authentication to provide secure communications over the network. With PPP authentication protocols such as Challenge Handshake Authentication Protocol (CHAP), Microsoft Challenge Handshake Authentication Protocol (MS-CHAP), and Password Authentication Protocol (PAP), the integrity and privacy of sensitive data is ensured.

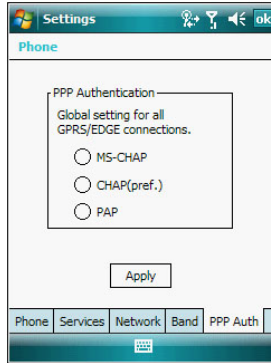

To set the global settings for your network connection:

- 1 On the **PPP Auth** tab, select a PPP authentication protocol.
- 2 Tap **Apply > ok**.

8 Using GPS Navigation

- GPS antenna
- Unpacking the MC35 vehicle mount kit
- Setting up MC35 on your vehicle
- Using MC35 safely

GPS antenna

MC35 has an internal micro-antenna for the GPS (Global Positioning System) receiver. This antenna, located beneath the top left of the device, receives radio signals and process position information between the device receiver and the satellite signals. GPS accuracy and signal availability and quality may be affected by your location, buildings, canyon walls, hard ground, and weather conditions. Use your device outdoors to allow reception of GPS signals.

Unpacking the MC35 vehicle mount kit

The vehicle mount kit includes:

- Vehicle mount
- Cradle plate
- Auto charger cable
- Headset

Setting up MC35 on your vehicle

WARNING! Some countries prohibit the mounting of any electronic device in any location on the vehicle dashboard. Be sure to check your local laws acceptable mounting areas before installing the auto mounting kit.

Installation reminders

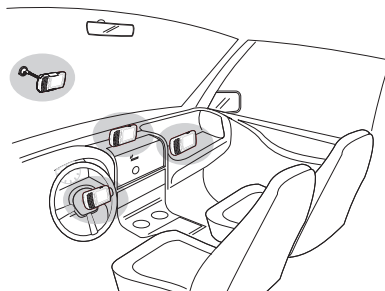

- Do not mount the device where it will obscure the driver's view of the road.
- Do not mount the device near the driver seat air bag deployment area.
- Do not place the device on top of the dashboard or anywhere without securing the device on the vehicle mount.
- Do not mount the device near the passenger seat air bag deployment area.

8 Using GPS Navigation

Setting up MC35 on your vehicle

- Install the vehicle mount on the surface of your vehicle that is reasonably flat and free of dirt and oil

Device mounting precautions

- Some countries prohibit the mounting of any electronic device in any location on the vehicle dashboard. Be sure to check your local laws acceptable mounting areas before installing the auto mounting kit.
- Some newer vehicle models may have a heat reflective shield embedded in the windshield. This may in some cases obstruct the GPS signal reception. In some cases, poor GPS signal are caused by:
 - Indoors and GPS cannot receive satellite positioning signal
 - Pylon or mobile phone base station
 - Bad weather, thunder, lightning, cloudy sky, fog, or rain
 - Driving at high speed
- The heating and cooling cycle of a vehicle's interior will in some cases loosen the adhesion of the suction cup. Check the vacuum seal of the vehicle mount kit for adequate adhesion each time you use the unit, and reinstall if necessary.
- If the vehicle mount kit has problems staying on, clean the plastic suction cup with alcohol, then reinstall.

To set up the device on your vehicle:

Install the vehicle mount on the surface of your vehicle that is reasonably flat and free of dirt and oil

- 1 Clean the mounting surface with a glass cleaner and a clean cotton cloth.
- 2 Install the vehicle mount on the windshield or other flat car surface.
 - (a) Fix the suction cup mount to the selected area with the suction lever facing up.
 - (b) Flip the lever down to create a vacuum between the suction cup and the mounting surface.

Make sure that the suction bond is strong enough before proceeding to the next step.
 - (c) Insert the vehicle mount's cradle plate to the holes on the back of the cradle.
 - (d) Move the car cradle until both parts are engaged.

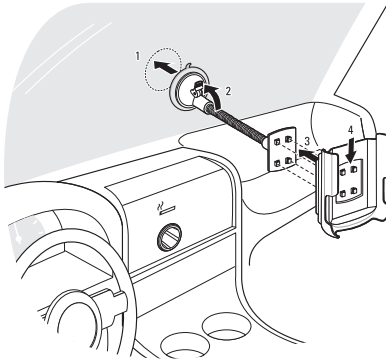

8 Using GPS Navigation

Setting up MC35 on your vehicle

- 3 Slide the device into the cradle.

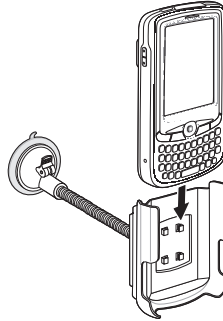

IMPORTANT: Before you start to use your device for GPS navigation, download the LTO (Long Term Orbits) first to update the Ephemeris data (current satellite position and timing information) onto your device. This data is needed to determine the GPS position of your current location.

- 4 The internal GPS receiver of your device is located as shown, for best GPS reception, make sure to mount your device in the correct position as shown in the illustration.

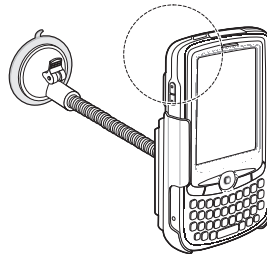

- 5 Connect the charger cable to the device and connect the other end of the charger cable to the cigarette lighter socket.

The LED indicator on the right side of the touch screen lights up orange during charging.

Downloading the LTO satellite data

Global Locate LTO satellite data provides guidance information about your current location and the distance and duration of travel. After the final location and time are calculated, the coordinates in the GPS are expressed in specific coordinate system, degrees and decimal degrees format, using the WGS 84 coordinate system.

The MC35 includes an Express GPS Connection application that makes use of the LTO satellite data, which can be downloaded using a GPRS/EDGE wireless data service connection or obtained from a server on the Internet through WLAN network. As an alternative to GPRS/EDGE or WLAN download, you can retrieve the LTO satellite data from a server on the Internet and transfer it to your MC35 when you connect it to your PC via ActiveSync or Bluetooth. After downloading the satellite orbit data, Express GPS Connection stores the data into the device's GPS chipset.

8 Using GPS Navigation



Setting up MC35 on your vehicle

For your first location fix, it is best to be outdoors under an open sky, with no tall buildings or other obstructions close by. It should take one to two minutes to compute the first position fix. After obtaining the first fix, Express GPS Connect operates at the optimum GPS performance level. If the data has expired, you should check your Express GPS Connect settings.

You have two options to download LTO—from the Today screen, using the **Express GPS Connect** icon  or the Express GPS Connect option under the **Settings > Connections** preferences.

NOTE: Be sure the current date is displayed on the MC35. If the date and time are not current, tap the **Clock** icon  on the Today screen.

To download the LTO satellite data file using Settings:

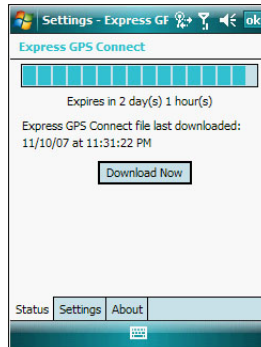

- 1 Start a remote connection to the server using a GPRS/EDGE or Wi-Fi connection.
- 2 Tap  > **Settings** .
- 3 On the **Connections** tab, tap **Express GPS Connect** .
- 4 Tap **Download Now**.

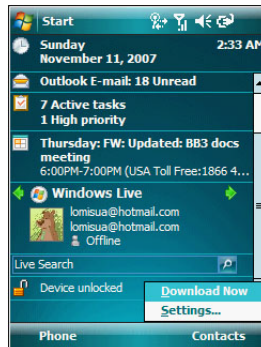

To download the LTO satellite data file using the Express GPS Connect icon:

- 1 On the **Today** screen, tap the **Express GPS Connect** icon , located on the lower right corner of the screen.
- 2 Tap **Download Now**.



Once activated, Express GPS Connect icon on the Today screen turns from gray  to blue .

See "Express GPS Connect" on page 171 for more information on how to use Express GPS Connection.

Using MC35 safely

For your safety, observe the following precautions carefully.

Driving precautions

- Do not attempt to enter information or configure the device while driving. If you need to do so, pull out of traffic and come to a stop in a legally permissible and safe location before using your device.
- Vehicle operators must maintain full surveillance of pertinent driving conditions at all times. Minimize the need to view the device screen while driving and use voice prompts to guide you.
- Never place the device on the passenger seat or any place else in the car where it can become projectile during a collision or stop.
- An air bag inflates with great force, DO NOT mount the device in the area over the air bag or in the air bag deployment area.

9 Using MC35 Companion Programs

- Phone management programs
- Wireless communication programs
- Media-related programs
- Product download-related programs

Phone management programs

These programs help you manage the contents of your SIM card.

- Use SIM Manager to manage contacts stored in your SIM card
- Use SIM Toolkit to access the mobile content and data services, such as news, weather, banking, and traveling information; offered by the mobile operators
- Use Gain Adjust to reduce ambient noise that a Bluetooth headset may have during a call



SIM Manager

SIM Manager enables you to manage all contacts stored on your SIM card. This program complements your device's phone function by enabling not just the addition of new phone numbers on your SIM card, but more importantly, exporting such contact information to Microsoft Contacts. This eliminates the need to manually enter these new contact information in your device.

To open SIM Manager:

- 1 Tap > **Settings** .
- 2 On the System tab, tap **SIM Manager** .

To copy SIM contacts to your device:

- 1 Tap > **Settings** .
- 2 On the System tab, tap **SIM Manager** .

Wait for SIM card contents to load. This may take a few seconds.



Idx	Name	Phone
10	Babes	0930853993
11	Bmw Agent	0910070292
13	Christine Yu	+639189241...
14	Wendy Tsai	0922573069
15	Dap	+639177374...
16	Daphne	0912786858
17	Transasia	0931750472
18	Dynasty	0227174949
20	Alex	0920532208
21	Alison Tuan	0926852585
22	Maritess Ang	+639175372...
23	Anie Richmon	0225619201
24	Archie Chen	0933229238
25	Yhl	0926186681
26	Auntie Elena	+1213623689
27	Benz Kuo'r	0935014364

9 Using MC35 Companion Programs

Phone management programs

- 3 Tap **Menu > Tools > Save All to Contacts**.

To copy a SIM contact to your device:

- 1 Tap  > **Settings** .
- 2 On the System tab, tap **SIM Manager** .

Wait for the SIM card contents to load. This may take a few seconds.



Idx	Name	Phone
10	Babes	0930853993
11	Bmw Agent	0910070292
13	Christine Yu	+639189241...
14	Wendy Tsai	0922573069
15	Dap	+639177374...
16	Daphne	0912786858
17	Transasia	0931750472
18	Dynasty	0227174949
20	Alex	0920532208
21	Alison Tuan	0926852585
22	Maritess Ang	+639175372...
23	Anie Richmon	0225619201
24	Archie Chen	0933229238
25	Yhl	0926186681
26	Auntie Elena	+1213623689...
27	Benz Kuo'r	0935014364

- 3 Tap and hold a SIM contact, then select **Save To Contacts**.

To view SIM information:

The SIM Manager also provides view of the settings, such as the service provider, phone book size, phone book used, maximum length of contact name, maximum length of phone numbers, and SMS message storage capacity.

- On the SIM Manager screen, tap **Menu > Tools > SIM Information**.

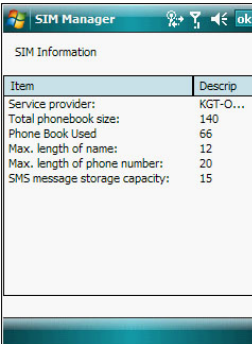

Item	Descrip
Service provider:	KGT-O...
Total phonebook size:	140
Phone Book Used:	66
Max. length of name:	12
Max. length of phone number:	20
SMS message storage capacity:	15

To export SIM text messages to the Inbox folder:

- On the **SIM Manager** screen, tap **Menu > Tools > Export All Messages to Inbox**.



To create a new SIM contact:

- On the **SIM Manager** screen, tap **New**.

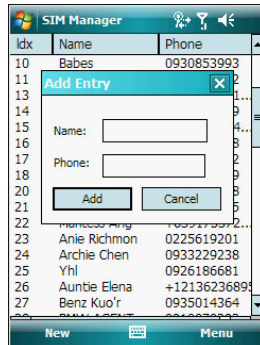

- Enter the contact name and phone number.
- Tap **Add**.

Procedures on how to perform the various SIM Manager operations is integrated on "Chapter 7 Using Phone" on page 109.

SIM Toolkit

SIM Toolkit enables you to access the online services offered by your mobile operator. This feature is dependent on your mobile operator. Online services, such as news, weather, banking, and traveling information can be accessed from your MC35. Check the availability of services with your mobile phone service provider.

To open SIM Toolkit:

- Tap  > **Programs**  > **SIM Toolkit** .

Wait for data contents to load. This may take a few seconds.

9 Using MC35 Companion Programs



Wireless communication programs

Gain Adjust

Gain Adjust is designed to provide better sound quality or noise reduction quality on your Bluetooth headset. You can adjust the headset's earphone and microphone signal levels to minimize unwanted background noise during a call.

NOTE: In order to reduce background noise to a minimum, the Receiving (Ear) and Sending (MIC) levels should be kept as low as possible.

To reduce noise during a call:

- 1 Ensure that the Bluetooth headset is paired and connected to the device.
- 2 Tap  > **Programs**  > **Gain Adjust** .

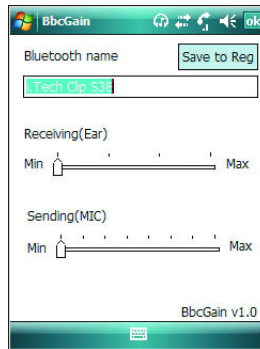

- 3 Drag the slider to adjust the earphone and microphone signal level. The noise source and the volume will increase as signal levels are maximized. You can also use the Volume up/down button on the Bluetooth headset or device to adjust the volume.
- 4 Tap the **Save to Reg** button to save current settings.
- 5 Tap **Yes** to reset the device immediately. Or, tap **No** to perform a manual reset of your device.

Wireless communication programs

- Internet Sharing
- Push to Talk
- Remote Desktop Mobile
- Express GPS Connect

Internet Sharing

Internet Sharing enables your computer to use the device as a modem for connecting to the Internet.

To use MC35 as a modem using a USB cable:

- 1 Ensure that the device is not connected to your computer.

- 2 Tap  > **Programs**  > **Internet Sharing** .

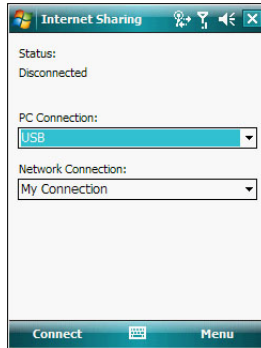



- 3 In the PC Connection list, select USB.
- 4 In the Network Connection list, select the connection type.
Select the network connection that the device should use to connect to the Internet.
- 5 Tap **Connect**.
- 6 Connect your device to your computer using a USB cable. The computer connects to the internet. In the Device Manager window "Windows Mobile-based Internet Sharing Device" displays in the Network adapters section.



The computer uses this new Network Connection to connect to the internet. If for some reason the MC35 loses internet connection, unplug the USB cable and repeat steps 2 through 6.

To use MC35 as a modem using Bluetooth:

- 1 Ensure that the device is not connected to your computer.
- 2 Tap  > **Programs**  > **Internet Sharing** .
- 3 In the PC Connection list, select Bluetooth PAN.
- 4 In the Network Connection list, select the connection type.
Select the network connection that the device should use to connect to the Internet.
- 5 Tap **Connect**.

9 Using MC35 Companion Programs

Wireless communication programs

- 6 On your computer, setup a Bluetooth PAN with your device.
 - (a) Select **Start > Control Panel > Network Connections**.
 - (b) Under **Personal Area Network**, select **Bluetooth Network Connection** icon.
 - (c) Under **Network Tasks**, select **View Bluetooth network devices**.
 - (d) In the **Bluetooth Personal Area Network Devices** window select your device.
 - (e) Click **Connect**.

The computer connects to the device via Bluetooth.

NOTE: If your computer is Bluetooth-enabled and you select Bluetooth as the PC connection, you must initiate and complete the Bluetooth PAN partnership before Internet Sharing will work. For more information, refer to Windows Help and Support.

Push to Talk

NOTE: Push to Talk application is not available on all configurations.

Push to Talk (PTT) is a walkie-talkie style service that provides simple communication with one person or with a group of people having compatible devices. With PTT, conversations are sent over cellular networks and only one person can talk at a time and then only by pressing the Push to Talk button. Calling a group of people can be conducted within set groups already established or created just before the session, by sending invitation messages among individual PTT participants or for users already involved in one PTT session. While using PTT, you can use the other functions of the MC35.

Before you can use PTT, you must define the required PTT service settings. See "Configuring the PTT Settings" on page 168 for more information.

PTT menu



The PTT menu lets you easily view PTT contacts, create an individual contact or a group, create a PTT name, configure auto accept invitations feature, or switch PTT on or off.

To open PTT:

- Tap  > **Programs**  > **Push to Talk** .

Using PTT

To initialize your PTT service:

- 1 Begin initializing your PTT service by performing one of the following:
 - Press the **Push to Talk** button on your device.
 - Tap  > **Programs**  > **Push to Talk** .

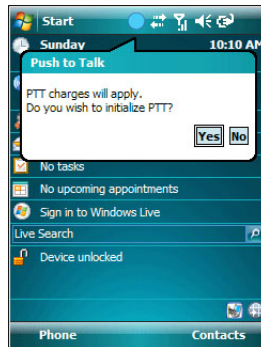

9 Using MC35 Companion Programs

Wireless communication programs

2 Tap **Yes**.

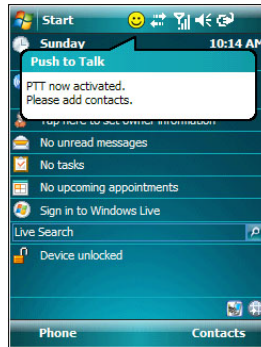

When activation is complete, notification prompt is displayed and the **User Presence** icon ☺ appears on the navigation bar.

The PTT Menu window appears.

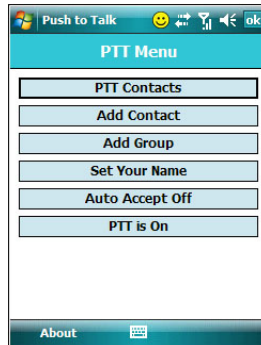

The PTT Menu window includes the following menu commands or parameters:

- PTT Contacts - Displays the PTT Contacts screen.
- Add Contact - Lets you create an individual PTT contact.
- Add Group - Lets you create a PTT group.
- Set Your Name - Lets you create a PTT user name.
- Auto Accept Off - Toggles the auto accept invitation feature.
- PTT is On - Toggles PTT on or off.

9 Using MC35 Companion Programs *Wireless communication programs*

To create an individual PTT contact:

- 1 Perform one of the following:
 - On the PTT Menu screen, tap **PTT Contacts > Menu > Add Contact**.



- On the PTT Menu screen, tap **Add Contact**.
- 2 Enter the name and mobile number of your contact.
-or-
Open **Contacts**, then select a contact to add to PTT.

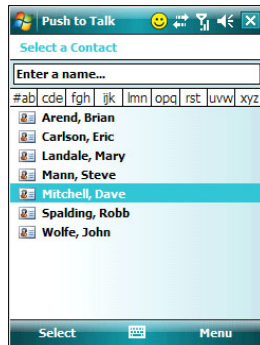

9 Using MC35 Companion Programs

Wireless communication programs

3 Tap **ok**.

The newly added contact, Dave Mitchell, appears in the list next to the Invitation in progress icon .

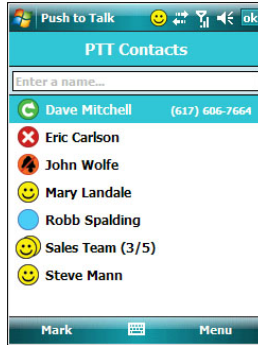

To rename a PTT contact:

1 Perform one of the following:

- On the PTT Menu screen, tap **PTT Contacts** > a **contact** > **Menu** > **Rename**.



- Tap and hold a contact in the PTT Contact list, then tap **Rename**.
- 2 Enter a new name for the contact, then tap **ok**.

The number in the screen is read only and cannot be modified.

To delete a PTT contact:

- On the PTT Menu screen, tap **PTT Contacts** > a **contact** > **Menu** > **Delete**.
- Tap **Yes**.

To create a PTT group:

1 Perform one of the following:

- On the PTT Menu screen, tap **PTT Contacts** > **Menu** > **Add Group**.
- On the PTT Menu screen, tap **Add Group**.

- 2 Enter a name for the new group and tap **ok**.

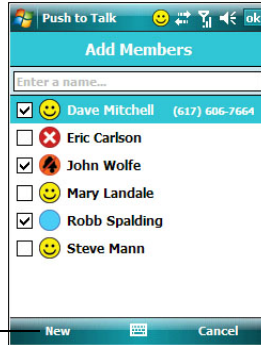

Tap to create new PTT contacts.

- 3 Select a contact to add in the group, then tap **ok**.

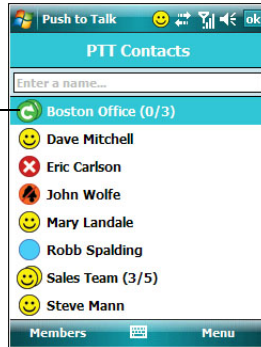

New group appears with the Invitation in progress icon.

To delete a PTT group:

- 1 On the **PTT Contacts** screen, select a group name.
- 2 Tap **Menu > Delete Group**.
- 3 Tap **Yes**.

To rename a PTT group:

- 1 On the **PTT Contacts** screen, select a group name.
- 2 Tap **Menu > Rename Group**.
- 3 Enter the new group name, then tap **ok**.

To leave the talk group:







- 1 On the **PTT Contacts** screen, select a group name.
- 2 Tap **Menu > Leave Group**.
- 3 Tap **Yes**.

9 Using MC35 Companion Programs

Wireless communication programs

PTT Contacts status icons

The list below shows the status icons that appear next to the individuals in PTT Contacts.

Icon	Name	Description
	Invitation in Progress	Displays when you have sent an invitation to join a group or you are waiting for an individual to accept your invitation. Once a member accepts, this status will change to Available.
	Do Not Disturb	Displays when a contact has changed their availability to Do Not Disturb. PTT calls cannot be placed.
	Silent/Vibrate	Indicates a contact has set their ringer to either Silent or Vibrate.
	Available (Individual)	Indicates the contact can receive a PTT call.
	Available (Group)	Indicates the group can receive a PTT call.
	Unavailable (Individual)	Contact has turned PTT off, powered down their device, or moved out of coverage.
	Unavailable (Group)	Group has turned PTT off, powered down their device, or moved out of coverage.

To change the availability status:

- 1 Press the **Push to Talk** button.
- 2 Tap **Menu > My Availability**, then select a status.

PTT calls

PTT calls can only be made to individuals or groups established in your PTT Contacts.

To make an individual or a group call:

- 1 Press the **Push to Talk** button.
- 2 Navigate to the individual or group you want to call, then press the **Push to Talk** button.



- 3 Tap **Speaker On** to turn on speaker.
- 4 Tap **To Cellular** to convert to Cellular call.

To receive an incoming PTT call:

- If your status is **Available**, PTT calls are automatically accepted, a **PTT call tone** is played and then **caller's voice** can be heard.
- If your status is **Silent/Vibrate**, the phone vibrates prompting you to accept or reject the call.
- If you receive a call while a call is in progress, a message box appears on the screen.

To view PTT Call History:

Perform one of the following:

- Press and hold the **Push to Talk** button.
- During an incoming call, tap **Menu > PTT History**.

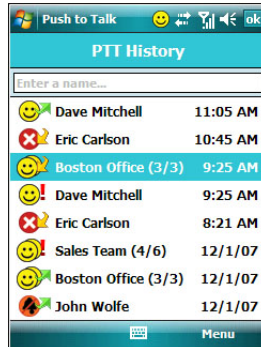

- On the **PTT History** screen, perform the following:
 - Make a PTT call by selecting a contact and pressing the **Push to Talk** button. Initiating PTT calls to dynamic or quick groups is not allowed.
 - Delete all or select items in the list by tapping **Menu > Delete All Calls**.
 - View all incoming and outgoing items by tapping **Menu > Filter > All, Incoming, or Outgoing**.

To send a Call Me Alert:

Call Me Alert is a message displayed across the receiver's screen

- 1 Press the **Push to Talk** button.
- 2 Select the individual you wish to alert.
- 3 Tap **Menu > Call Me Alert**.

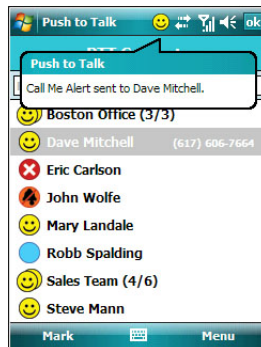

- 4 Tap **ok**.

9 Using MC35 Companion Programs

Wireless communication programs

Configuring the PTT Settings

You can configure most features of the PTT to suit your preferences. You do this by accessing the Set Your Name, Auto Accept Off, or PTT is On commands in the PTT menu.

To change your presence status:

- 1 Press the **Push to Talk** button.
- 2 Tap **Menu > My Availability** > turn it on or off.

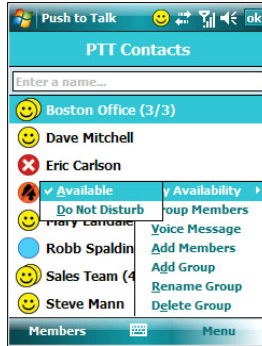

To auto accept invites:

- 1 On the PTT Menu screen, tap **Auto Accept Off**.

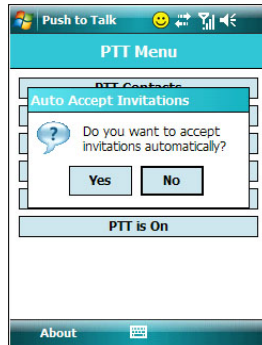

- 2 Tap **Yes**.

To turn off PTT:

- 1 On the PTT Menu screen, tap **PTT is On**.

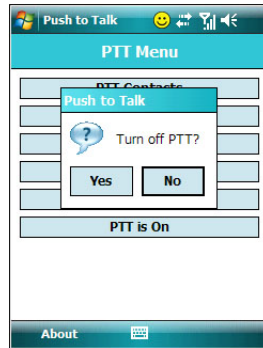

- 2 Tap **Yes**.





Remote Desktop Mobile

Remote Desktop Mobile is based on Terminal Services Technology. Use Remote Desktop Mobile to log onto a Windows Terminal Server type computer and use all of the programs that are available on that computer from your device. For example, instead of running Word Mobile, you can run the PC version of Microsoft Word and access all of the .doc files on that computer from your device.

NOTE: Procedures described in this section applies to computers using the Windows 2000 or later version operating system.

To create a remote connection to a computer:

- 1 Start a remote connection to the server using a GPRS or Wi-Fi connection.
- 2 Tap  > **Programs**  > **Remote Desktop Mobile** .

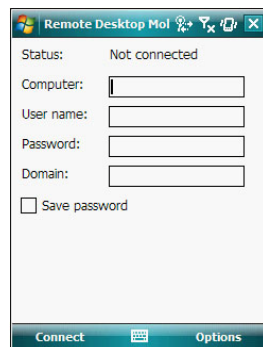

- 3 Enter a server name.
- 4 Enter the user name and password.
- 5 If a domain is required, enter the domain address.

9 Using MC35 Companion Programs

Wireless communication programs

6 Tap **Connect**.

Once connected to the server, the computer's screen may more than fill your device's screen. If scroll bars are displayed on the server's screen, you will see more than one set of scroll bars on your device—one to scroll information on the computer, and the other one to scroll the Remote Desktop Mobile screen. To ensure you are scrolling the PC window contents, use the five directional buttons at the bottom of the screen.

7 For more information on Remote Desktop Mobile, tap > **Help** .

To improve display performance:

Display performance is improved by decreasing the time it takes for the screen to be refreshed on the PC.

- 1 On your PC, select **Start > Settings > Control Panel**.
- 2 Double-click **Display**.
- 3 On the **Appearance** tab, click **Effects**.
- 4 Clear the "Use the following transition effects for menus and tool tips" check box.
- 5 Click **Apply**, then **OK**.

To improve browser performance:

The performance of Internet Explorer on your PC is improved by decreasing the time it takes for Web pages to be refreshed.

- 1 In Internet Explorer on your PC, select **Tools > Internet Options > Advanced** tab.
- 2 Under **Browsing**, clear the "Use smooth scrolling" check box.

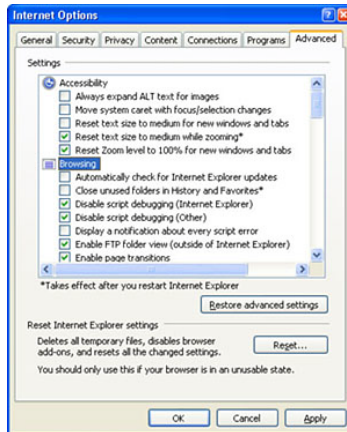

- 3 Click **Apply**, then **OK**.

To disconnect and end a session:



- 1 In the Remote Desktop Client PC window, click **Start > Shut Down**.
- 2 On the **Shut Down Windows** dialog box, click **Log Off [user name]**.
- 3 Click **OK**.

NOTE: If the network administrator has configured Remote Desktop Client to reconnect to disconnected sessions, you will be reconnected to this session the next time you connect to this server.

Express GPS Connect

MC35 is integrated with the latest GPS (Global Positioning System) technology to quickly compute positions in locations where GPS signals are barely detectable. Optimum GPS performance can be achieved with Express GPS Connect. This program operates by transferring GPS satellite data (ephemeris information) from the Internet to your device, where it is stored in memory. Express GPS Connect can get satellite data when your MC35 is connected to your PC or the Internet. This process occurs in the background, ensuring the GPS functions are ready to use at all times.

To open Express GPS Connect:

- 1 Start a remote connection to the server using a GPRS or Wi-Fi connection.
- 2 Tap  > **Settings** .
- 3 On the Connections tab, tap **Express GPS Connect** .

Using Express GPS Connect

Use Express GPS Connect for the first time

The first time you use your MC35 EDA, make sure your Express GPS Connect satellite data is current. For your first location fix, it is best to be outdoors under an open sky, with no tall buildings or other obstructions close by. It should take one to two minutes to compute the first position fix. After obtaining the first fix, Express GPS Connect operates at the optimum GPS performance level. If the data has expired, you should check your Express GPS Connect settings.

Express GPS Connect position fix times

- The time it takes for Express GPS Connect to get a position fix varies with signal reception conditions. In open and nearly open sky conditions, the MC35 typically can get a position fix in just a few seconds. In blocked signal conditions Express GPS Connect will start in one minute or less if the GPS signals are sufficiently strong.
Using your MC35 near a window gives it a better view to the sky and improves the chance of a successful position fix.
- Express GPS Connect starts searching for signals based on the most recent position fix. When traveling to a new location your MC35 will need extra time and more open signal conditions to obtain a location fix. After your first fix in the new location full performance is restored.
- When traveling to a different time zone, you can change the time zone settings to tell Express GPS Connect you have traveled.

Satellite reception

- GPS receivers work best when they have a direct line of sight to the satellites. For example, somebody turning on a GPS receiver in the middle of the Gobi Desert will obtain a position fix much sooner than a GPS user trying to get a position fix in the middle of Wall Street. The reason for this is simple: the Gobi Desert is a huge, flat expanse. It has no tall buildings and very few natural obstructions that could block GPS signals. GPS is ideal for an "open sky" environment like the Gobi Desert.
- In contrast, Wall Street represents an "urban canyon" environment, where tall buildings on both sides of the street block, reflect, and scatter incoming GPS signals. These conditions also apply when trying to use a GPS receiver indoors. A traditional GPS receiver simply may not be able to compute a position in an urban canyon or indoor environment.
- When you are getting your first GPS position fix with the MC35, try to do it in an environment that is as close to "open sky" as possible. The first position fix is crucial because it includes a calibration process that helps subsequent position fixes to be computed more rapidly. After getting the first position fix, you will be able to enjoy the benefits of the Express GPS Connect's high-sensitivity technology, which, when coupled with Express GPS Connect satellite data, allows you to get position fixes in places where traditional GPS receivers can't.

9 Using MC35 Companion Programs

Wireless communication programs



How to improve GPS performance

Your MC35 computes your position faster and more accurately, provided the following are adhered to:



- Always operate with current Express GPS Connect data.
- Configure your MC35 to automatically update Express GPS Connect data.
- Keep the MC35 away from other electronic devices that may emit radio waves (such as laptop computers and USB devices).
- Protect your MC35 from extreme temperature variations and violent shocks.
- If you are indoors and do not get a position after one minute, move to a window to give the MC35 a better view of the sky.
- If you have traveled more than 500 miles since you last used your MC35, or if the unit has been reset, the next position computation should be performed under open sky conditions, and extra time should be allowed.
- When traveling to a different time zone, be sure to change the MC35's time zone settings.
 - If you have traveled more than 500 miles from the location where you last used the MC35's GPS capability, the device will need extra time to compute a position fix. Here are a few ways to reduce the time to obtain a position in your new location.
 - If traveling by plane, it is best to wait until you leave the terminal building before trying to obtain your first position fix.
 - After the device obtained the first position fix in a new region, optimum Express GPS Connect performance is restored.
 - If you have traveled to another time zone, you can speed up the GPS position computation by changing the time zone settings on your device. This causes Express GPS Connect to proceed immediately to a global satellite search.
 - If you do not change the time zone, Express GPS Connect will initially search for satellites based on your previous position, increasing the time required to obtain a position fix.

Express GPS Connect status icons

The Express GPS Connect icon  located on the lower right corner of the Today screen indicates the expected level of GPS performance and the amount of time until the Express GPS Connect data expires.

Icon	Description
	Indicates satellite data is valid and current
	Indicates satellite data is valid and is due to expire within 24 or fewer hours
	Indicates satellite data has expired

Downloading the Express GPS Connect Data File

You have two options to download satellite data—from the Today screen, using the Express GPS Connect icon ; or the Express GPS Connect option under the Settings > Connections preferences. Once activated, Express GPS Connect icon on the Today screen turns from gray  to blue .

NOTE: Be sure the current date is displayed on the MC35. If the date and time are not current, tap the **Clock** icon  on the Today screen.

To download the satellite data file using Settings:

- 1 Tap **Settings**.
- 2 On the **Connections** tab, tap **Express GPS Connect**.
- 3 Tap **Download Now**.

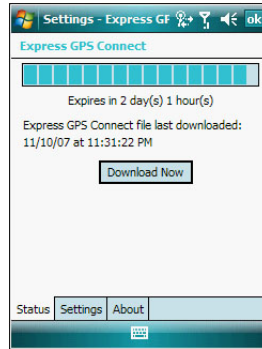

To download the satellite data file using the Express GPS Connect icon:

- 1 On the **Today** screen, tap the **Express GPS Connect** icon, located on the lower right corner of the screen.
- 2 Tap **Download Now**.

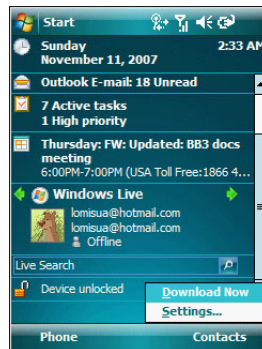

- 3 Tap **ok**.

To refresh satellite data:

Your device can refresh satellite data through the following:

- PC with Internet connectivity using ActiveSync or Bluetooth.
- GPRS/EDGE wireless data service connection.
- ActiveSync to obtain Express GPS Connect data files already stored on your PC. This method requires you to install the supplied PC utility that retrieves Express GPS Connect data through the Internet.
- With any of these methods, your MC35 can be configured to refresh Express GPS Connect satellite data automatically, or you can manually refresh the data by tapping **Download Now**.

9 Using MC35 Companion Programs



Wireless communication programs

Configuring the Express GPS Connect

You can set preference settings on how to use Express GPS Connect. You can perform the following configuration options in Express GPS Connect:

- Specify Express GPS Connect to obtain satellite data updates.
- Specify Express GPS Connect to automatically update using a GPRS connection.
- Specify Express GPS Connect to show expiration reminders and warnings.
- Specify Express GPS Connect to display an icon on the lower right corner of the Today screen.

To configure the Express GPS Connect settings:

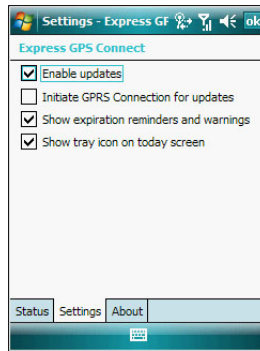

- 1 Tap  > **Settings** .
- 2 On the **Connections** tab, tap **Express GPS Connect** .
- 3 On the **Express GPS Connect** screen, tap the **Settings** tab.



- 4 On the **Settings** tab, set the following options:
 - Tap "Enable updates" check box to enable Express GPS Connect to obtain satellite data. If disabled, ActiveSync must be used to obtain data.
 - Tap "Initiate GPRS connection for updates" check box to allow Express GPS Connect to automatically update data on the device using a GPRS connection.
 - Tap "Show expiration reminders" check box to receive notifications when a satellite data has expired before you start a location application. If disabled, the device operates without the benefit of Express GPS Connect and GPS performance is unfavorable.
 - Tap "Show tray icon on Today screen" check box to display an icon on the lower right corner of the Today screen.
- 5 Tap **ok**.

To perform an Express GPS Connect factory reset:

MC35 Express GPS Connect saves information related to GPS operation that reduces the time required to compute positions. If there is a problem with the MC35's memory, this information might be corrupted.

- 1 Tap  > **Settings** .
- 2 On the **Connections** tab, tap **Express GPS Connect** .

- 3 On the Express GPS Connect screen, tap the **About** tab.



- 4 Tap **Advanced > Factory Reset**.

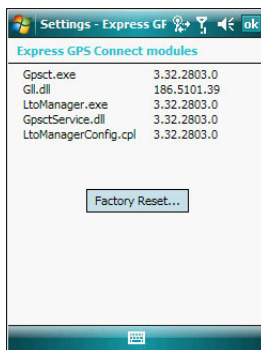

- 5 Tap **OK**. This removes all of the Express GPS Connect internal operating information and restores the factory default settings.

Media-related programs

- Pictures & Videos
- Camera
- Camera Wedge

Pictures & Videos

Pictures & Videos extends your device's function to the visual scene with its image management, viewer and editing functions. It supports BMP, GIF and JPEG image formats, as well as record and launch video clips stored on your device or on a storage card. Now you can keep those images of your favorite moments as mobile as you are.

To open Pictures & Videos:

- Tap  > **Programs**  > **Pictures & Videos** .

Tap to launch the Camera application.

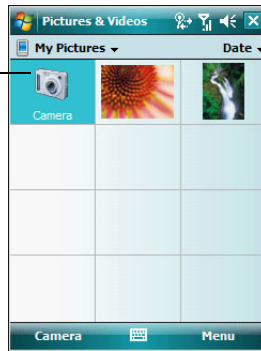

Pictures & Videos opens to a thumbnail view of all image files stored on the My Pictures folder on your device and/or on a storage card attached to your device.

You can use Pictures & Videos to perform any of the following:

- View images in thumbnail, full screen or slide show mode
- Edit BMP, GIF and JPEG images
- Set a BMP, GIF and JEG image as the background of the Today screen, similar to using a wallpaper on your computer's desktop screen.
- Send an image file or video clip via infrared or using Inbox
- Record a video clip
- Launch video clips stored on your device.
- Launch the Camera application.

Copying image files or video clips to your device

To view your image files and video clips in Pictures & Videos, copy the files to the My Pictures folder of your device or on a storage card folder.

To copy image files or video clips from your computer to your device:

- 1 Connect your device to your computer.
- 2 In ActiveSync on your computer, click **Explore** .
Windows Explorer opens the Mobile Device window for your device.
- 3 Locate then select the file(s) that you want to copy on your device.
- 4 Right-click the selected file(s), then click **Copy**.

- 5 Place the cursor on the My Pictures folder of the Mobile Device window, right-click, then click **Paste**.

In Pictures & Videos, tap to view image files stored in the My Pictures folder.

To copy image files from a storage card to your device:

- 1 Install the storage card to your device's SD/MMC expansion slot.
- 2 Perform steps 1-4 of the procedure above.
- 3 Locate the Storage Card folder under the My Windows Mobile-Based Device directory.
- 4 Open the folder under the Storage Card folder where you want to save your image file(s).
- 5 Place the cursor on the selected folder, right-click, then click **Paste**.
In Pictures & Videos, tap to view image files stored in an attached storage card.

Organizing photos and videos

You can use Pictures & Videos to organize and search for images stored on your MC35 or on a storage card. You can also edit images and send them as an e-mail attachment, view a slide show of your pictures or set a picture as a background on the Today screen. Pictures & Videos display images in any of the three view modes—thumbnail (default), full screen, and slide show.

Thumbnail mode

Thumbnail mode is the default view mode every time you open Pictures.

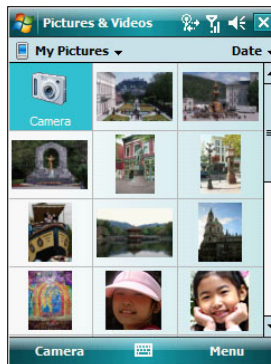

You can perform the following while in thumbnail mode:

- Tap and hold a thumbnail to display a pop-up menu of available actions.
- Place your stylus within the edge at the far left or far right of the screen and then drag the stylus over the images to perform multiple selections useful in deleting images by batch rather than by thumbnail.
- Move the joystick up or down to select the previous/next thumbnail.

9 Using MC35 Companion Programs

Media-related programs

To perform image management tasks:

It is only in thumbnail mode can you perform most of the image management tasks.

- 1 Tap and hold a thumbnail to display a pop-up menu of available actions.

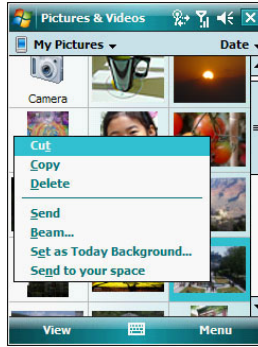

- 2 Perform any of the following:
 - Tap **Cut** to move image file to the Storage Card folder.
 - Tap **Copy** to create a duplicate image file. This is useful when you want to edit an image but still want to retain an original copy of the image.
 - Tap **Delete** to remove the selected thumbnail from its location. You are prompted to confirm the deletion.
 - Tap **Send** to attach image as an attachment to an e-mail.
 - Tap **Beam** to send the thumbnail to another Bluetooth or IR-enabled device.
 - Tap **Set as Today Background** to set image as background of the Today screen.
 - Tap **Send to your space** to upload image to Windows Live Space.

Full screen mode

It is only in full screen mode can you perform any editing action on an image.

To view image in full screen mode:

- Tap a thumbnail or press the joystick while a thumbnail is selected. In this view, the selected image is maximized so that it fits the entire screen (with the navigator and command bars still visible) used to display it.

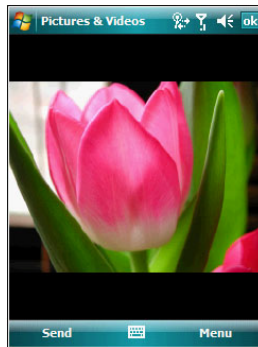

Tap **ok** or press the joystick to return to thumbnail mode.

To change the image orientation:

You can change the display orientation of an image.

- On the command bar, tap **Menu > Edit > Rotate** to rotate the image 90° counter-clockwise.

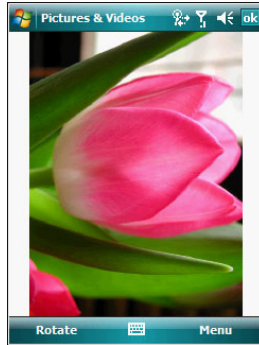

To crop part of an image:

You have the option to specify a portion of an image and then save that portion as a new JPEG file.

- 1 Tap **Menu > Edit**.
- 2 Tap **Menu > Crop** to enable the Crop tool.
- 3 Drag your stylus across part of the image you want to crop.
- 4 Tap inside the selection.

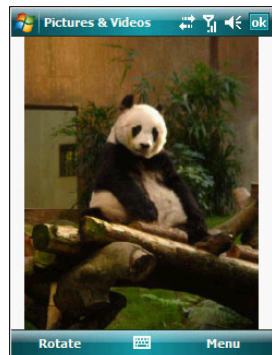
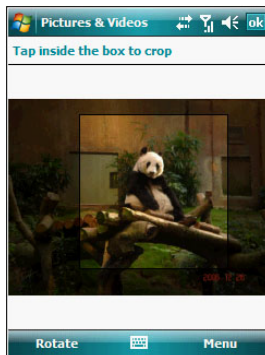

- 5 Tap **Menu > Save As**.

9 Using MC35 Companion Programs

Media-related programs

- 6 Fill out the fields in the **Save As** screen.



- 7 Tap **ok**.

To zoom in/zoom out the image:

To view images in a larger or smaller scale use the Zoom tool.





- 1 Tap the image.
- 2 Tap **Menu > Zoom**.

A zoom selection panel appears on the lower right corner of the screen.

- 3 Tap the **Magnify** button  to enable the zoom selection tools.

The full screen image zooms in and a red selection border automatically appears on the image inside the zoom selection panel.



- 4 Perform any of the following:
 - Tap  to magnify the size of the image.
 - Tap  to reduce the size of the image.
 - Tap  to zoom into an image.
 - Tap  to return the image to its original view size.
 - Drag the red box within the small frame to pan the image in any direction you want.
- 5 Tap **Menu > Zoom** to hide the zoom selection panel.

To set an image as a Today wallpaper:

To add a custom look to the Today screen of your device; apply a wallpaper of your choice using any image.

- 1 Tap and hold a **thumbnail**, then tap **Set as Today Background**.

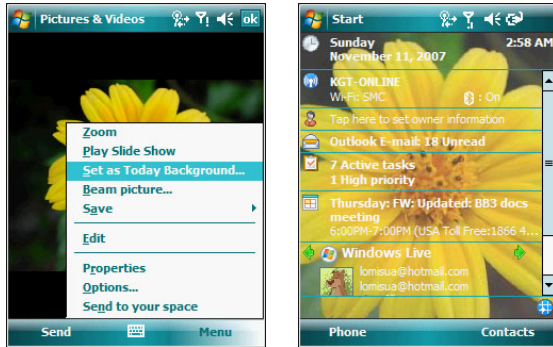

- 2 Tap the **up or down** arrows to set the transparency level.
- 3 Tap **ok**.

Slide show mode

You can view images in a slide show much like viewing a PowerPoint presentation in your computer. Images are adjusted to fit the entire display area and are shown in a five seconds interval (default).

To view image in slide show mode:

- In **thumbnail** mode, tap **Menu > Play Slide Show**.
During the slide show, you can use hardware buttons to control the image display. Move the joystick up or down to display the previous image; rotate down to display the next image.

To view the Slide Show toolbar:

- During the slide show, tap anywhere on the screen or press the joystick.

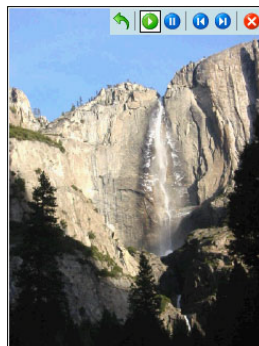





The icons in the Slide Show toolbar lets you control the pace of the slide show, as well as change the orientation of the images.

- Tap  to rotate the images counterclockwise.

9 Using MC35 Companion Programs

Media-related programs

- Tap  to continue the slide show after pausing it.
- Tap  to pause the slide show.
- Tap  to display the previous image.
- Tap  to display the next image.
- Tap  to stop the slide show. Screen returns to thumbnail mode.

Customizing Pictures & Videos

Using the Options command you can set preference settings on how to use Pictures & Videos.

To customize Pictures & Videos:

- 1 On either thumbnail or full screen mode, tap **Menu > Options**.
- 2 On the General tab, set the following options:

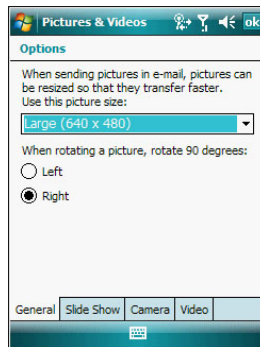

- Select the size of the pictures you want to send through e-mail. Only pictures sent through an e-mail message is resized, the original picture remains unchanged.
 - Resize pictures for faster e-mail transfer
 - Rotate pictures towards left or right.
- 3 On the Slide Show tab, set the following options:

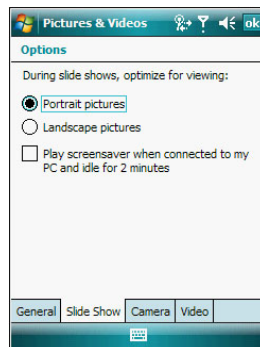

- Select the "Portrait pictures" or "Landscape pictures" radio button to set slide show orientation.
 - Select the "Play a screensaver when connected to my PC and idle for 2 minutes" check box to set the image files in the My Pictures folder as a screensaver whenever your device is connected to the USB sync cable and is idle for 2 minutes.
- 4 On the Camera tab, set the following options:

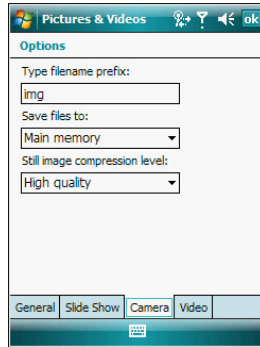

- In the Type filename prefix box, enter the prefix to be used as a default title for the image file.
 - In the Save files to list, select to save image files to onboard memory or built-in storage.
 - In the Still image compression level list, set a compression level when saving the image. The high quality setting provides the best image quality but more memory is required.
- 5 On the Video tab, set the following options:

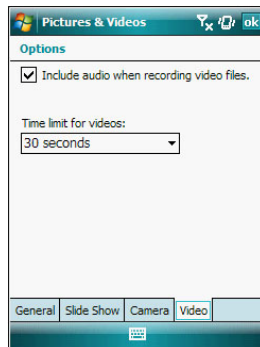

- Select the "Include audio when recording video file" check box, to include audio when recording video files.
 - In the Time limit for videos list, select the length for video clips recorded with the camera.
- 6 Tap **ok**.

You can take photos and videos and capture bar code data with the device's built-in camera. The camera lens is located on the rear of the device. Images can be stored on the device's onboard memory or a memory card. Once you take photos or video clips, you can associate the image with a name in the phone book, e-mail it to friends, or send it to other Pocket PCs or phones. You can also send images to your computer via Bluetooth or IR.

9 Using MC35 Companion Programs





Media-related programs

NOTE: The image capture application must be installed and enabled in order to operate the data capture. For more information on the type of image capture application compatible with your device, refer to the Zebra website.

Camera

With the Camera application you can take pictures and shoot videos, and modify settings with Camera while you are on mobile. The images and video clips are automatically saved in the Pictures & Videos application, where you can view and edit them. By default captured images or videos are saved as JPEG or WMV file.

To open Camera:

- 1 Perform one of the following:
 - Press the **Camera** button located on the lower-right side of the phone, to activate the camera.
 - Tap  > **Programs**  > **Pictures & Videos**  > **Camera** .
 - Open Pictures & Videos, then tap **Camera** on the command bar.

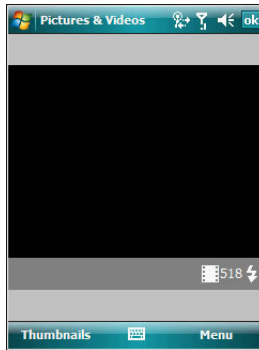



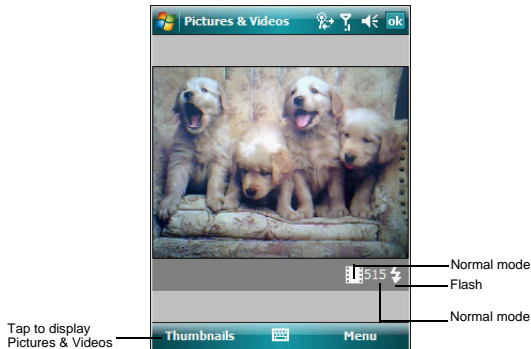

Camera screen

The Camera screen displays the view finder. Information about the current settings or the remaining number of images that can be saved to your device are displayed on the lower right corner of the screen. This screen also provides an option to toggle shooting mode between camera and video mode.



To switch shooting mode from camera mode to video mode:

- 1 Launch Camera, by performing one of the following:
 - Press the **Camera** button located on the lower-right side of the phone, to activate the camera.
 - Tap  > **Programs**  > **Pictures & Videos**  > **Camera** .
 - Open Pictures & Videos, then tap **Camera** on the command bar.
- 2 Tap **Menu > Video**.

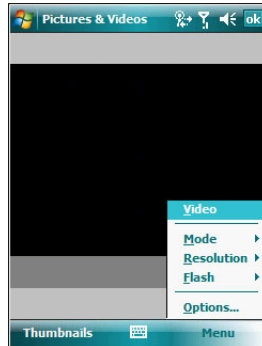



To switch back to camera mode, tap **Menu > Still**.

Camera capture mode





The MC35 offers two types of camera capture mode:

- Camera - for taking pictures and recording videos
- Bar code - for capturing a bar code data

To select a camera capture mode:

- Slide the Camera/Bar Code switch to the **Camera** icon  or the **Bar code** icon  to switch from one capture mode to another.

To take a photo:

- 1 Launch the Camera application by performing one of the following:
 - Press the **Camera** button located on the lower-right side of the phone, to activate the camera.
 - Tap  > **Programs**  > **Pictures & Videos**  > **Camera** .
 - Open Pictures & Videos and tap **Camera** on the command bar.
- 2 Check the image on the view finder, adjust if necessary.

9 Using MC35 Companion Programs

Media-related programs

- 3 Press the **Camera** button to take the picture.

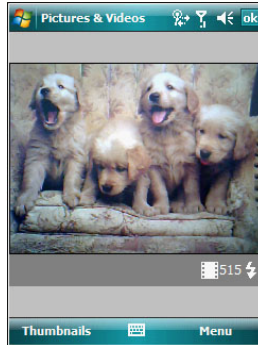

To take photos using burst mode:

Burst mode is a way to take a series of quick pictures.

- 1 Launch the Camera application.
- 2 Tap **Menu > Mode > Burst**.
- 3 Press the **Camera** button to take the picture.

To stop a burst of pictures before all pictures have been taken, close Camera.

To take photos using timer:

Using the timer, you can take a self-portrait. Just place the device on a stable support and press the camera button, then get into position.

- 1 Launch the Camera application.
- 2 Tap **Menu > Mode > Timer**.

NOTE: By default, the self timer delay is set at five seconds.

To record a video clip:

- 1 Launch the Camera application.
- 2 Tap **Menu > Video** to set shooting mode to video.

The available recording time displays on the screen.

NOTE: By default, the time limit for recording videos is set at 15 and 30 seconds.

- 3 Press the **Camera** button to begin recording.

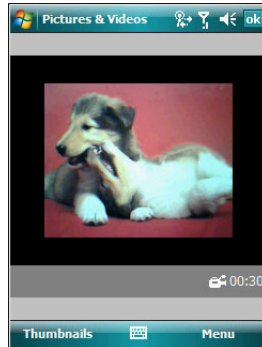

Recording stops when you press the **Camera** button again.

To select video quality:

You can specify the quality (video resolution and sound fidelity) and size of the video clips you record. Video clips of higher quality require more memory.

- 1 On the Camera screen, tap **Menu > Video**.
- 2 Tap **Menu > Quality**.

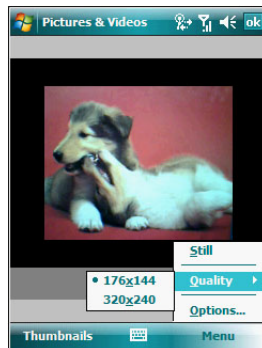

- 3 Select a video quality.
- 4 Tap **ok**.

To select picture compression:

You can set the compression level for the pictures you take. Note that selecting a high quality picture increases the size of the file significantly.

- 1 On the Camera screen, tap **Menu > Video**.
- 2 Tap **Menu > Options > Camera** tab.
- 3 In the Still Image compression level box, tap the desired compression level.

To set default location where photos are saved:

You can set the default location where pictures are saved. If you select main memory, pictures are saved to permanent storage on your device, which may require that you consider the storage needs of other programs.





- 1 On the Camera screen, tap **Menu > Video**.
- 2 Tap **Menu > Options > Camera** tab.
- 3 In the "Save files to" list, select main memory or storage card.

9 Using MC35 Companion Programs

Media-related programs

4 Tap **ok**.

To capture bar code data:

- 1 Start the CamWedge application.
 - Tap  > **Programs**  > **CamWedge** .
- 2 On the Today screen, tap and hold the **CamWedge** icon  located on the lower right corner of the screen, select **Test** from the CamWedge menu.
- 3 Place the **Camera/Bar Code** switch to the **Bar Code**  position.
- 4 Press and hold the **Camera** button.
- 5 Point the MC35 toward the **bar code** and align if necessary. A small window appears on the screen. Align the bar code in the window.
- 6 Press the **Camera** button to capture the bar code data. The device beeps when the bar code data is captured.

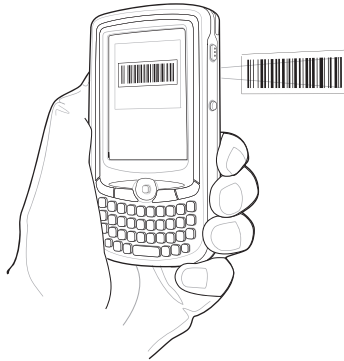

- 7 Tap the **x** button to exit the CamWedge Test screen.
- 8 Exit the CamWedge application.
 - On the Test screen menu bar, tap **Exit** > **Exit**.

To view photos and video clips:

- 1 Tap  > **Programs**  > **Pictures & Videos** .

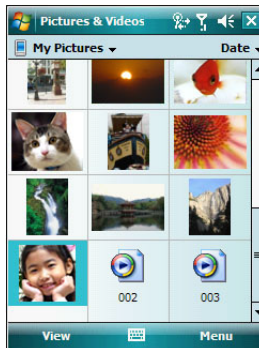

- 2 Tap the picture or video clip that you want to see.





To configure the camera settings of your device:

- 1 Launch the Camera application.
- 2 Tap **Menu**, then configure the device settings.
 - Video - Tap to switch to video or still (camera) mode.
 - Mode - Select from the following modes to take your picture:
 - Normal - Takes picture using the default settings.
 - Burst - Takes picture consecutively in continuous mode.
 - Timer - Takes picture five seconds after pressing the Camera button.
 - Resolution - The default resolution setting is 650 x 152 pixels.
 - Flash - Turns flash on and off.
 - Options - Displays the camera options screen.
- 3 Tap **ok** to exit.





CamWedge

CamWedge enables bar code data capture with the MC35.

To open CamWedge:

- Tap  > **Programs**  > **CamWedge** . Once activated, the CamWedge icon  appears on the lower right corner of the Today screen. Bar code data capture is enabled by default when CamWedge is launched. A check mark appears alongside Barcode in the menu when it is enabled.

To view the CamWedge menu:

- Tap  > **Programs**  > **CamWedge** .
- On the Today screen, tap and hold the **CamWedge** icon  located on the lower right corner of the screen.

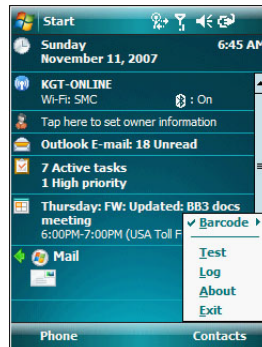

The CamWedge menu includes the following:

- Barcode - Displays the status of CamWedge and allows you to view or modify a bar code configuration type.
 - Enable - Allows data capture when pressing the **Camera** button.
 - Disable - Prevents data capture from occurring when pressing the **Camera** button.
 - Prefix/Suffix - Allows modification of the bar code data.
 - Options - Allows you to set options for capturing bar codes.
- Test - Allows data capture operations to be tested locally.
- Log - Displays information logged by CamWedge.
- About - Displays the CamWedge info screen.
- Exit - Closes the application.

9 Using MC35 Companion Programs

Media-related programs

Configuring the CamWedge settings

Use the CamWedge menu to set preference settings on how to use CamWedge. You can perform the following configuration options in CamWedge:

- Enable or disable the bar code data capture
- Specify the bar code prefix or suffix options
- Set the options for capturing bar codes

To enable or disable bar code data capture:

- On the CamWedge menu, select **Barcode > Enable**.
- On the CamWedge menu, select **Barcode > Disable**. The **CamWedge** icon on the Today screen changes from  and .

To specify the bar code prefix/suffix options:

- 1 On the CamWedge menu, select **Barcode > Prefix/Suffix**.

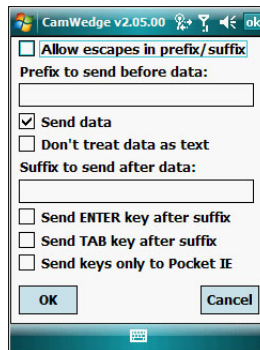

- 2 Set the following options:

- Tap the "Allow escapes in prefix/suffix" check box to enable escape sequences to be embedded in prefix and suffix strings. Escape sequences allow non-textual data to be transmitted as part of the prefix or suffix string. All escape sequences begin with the backslash "\" character. The supported escape sequences include:
 - \b Backspace
 - \f Form feed
 - \n New line (line feed)
 - \r Carriage return
 - \t Tab
 - \xHH ASCII character represented in Hexadecimal notation. Consult a standard ASCII chart for suitable values.
 - \vHH Virtual key code represented in Hexadecimal notation.
- In the "Prefix to send before data" box, enter the string to be sent before the captured data.
- Tap the "Send data" check box to disable this option. By default, this option is enabled to allow transfer of the captured bar code data to the device. Disabling this option prevents the actual data from being transmitted. The prefix and suffix strings, if present, are still transmitted even if this option is disabled.
- Tap the "Don't treat data as text" check box to read bar code data as binary data and transmit the data in hexadecimal format. By default, this checkbox is disabled. This option does not affect the Test function in CamWedge, which has its own mechanism to display Hex and text formats.
- In the "Suffix to send after data" box, enter the desired string to be sent after the captured data.
- Tap the "Send ENTER key after suffix" check box to transmit an ENTER key (VK_RETURN virtual key code) following all other data.

- Tap the "Send TAB key after suffix" check box to transmit a TAB key (VK_TAB virtual key code) following all other data.
- Tap the "Send keys only to Pocket IE" check box to enable the AutoPIE mode. The AutoPIE mode allows CamWedge to work correctly with Pocket Internet Explorer. AutoPIE mode enables bar code data capture when the cursor is on a field that can accept keyboard input. This allows for better power management and eliminates any confusion caused by capturing when there is no field to accept the data.

3 Tap **ok**.

To configure the options for capturing bar codes:

1 On the CamWedge menu, select **Barcode > Options**.

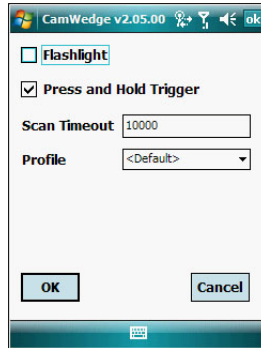

- 2 Tap the "Flashlight" check box to enable the flashlight when capturing bar code data.
- 3 Tap the "Press and Hold Trigger" check box causes the device to stop the bar code decoding session when the Camera button is released. If disabled, the bar code decoding session continues until a bar code is decoded or the Scan Timeout is reached.
- 4 In the "Scan Timeout" box, enter the scan timeout in milliseconds. If no bar code is decoded the scanner stops decoding after the given Scan Timeout elapses.
- 5 In the "Profile" drop-down box, select a bar code symbology. The profile selected determines which bar code type to decode.
- 6 Tap **ok**.

Test window

The Test window displays information processed from the data captured by the MC35. This window is typically used to ensure that the captured data is being transmitted as expected. When the CamWedge screen is closed, normal operation resumes sending any captured data to the foreground application.

9 Using MC35 Companion Programs

Media-related programs

To open the **Test** window:

- 1 On the **CamWedge** menu, select **Test**.

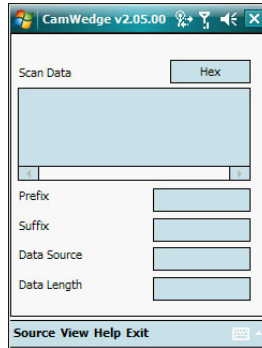

The Test window includes a button to toggle the data capture format between hexadecimal and text and a menu bar with all of the CamWedge functions.

Log window

The Log window displays a scrolling list of the actions performed. This does not include the captured data. The Log window is typically used to confirm the actions of the user.

To open the **Log** window:

- On the **CamWedge** menu, select **Log**.

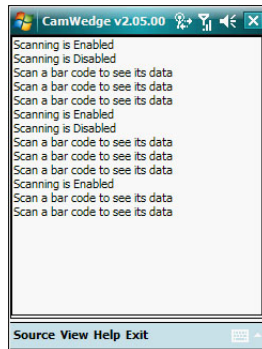

A menu bar with all of the CamWedge functions is available within the window.

Product download-related programs

- AirBEAM Smart
- Rapid Deployment Client
- MSP Agent
- Certificate Import

Air **BEAM** AirBEAM Smart

The AirBEAM Smart product allows specially designed software packages to be transferred between a host server and MC35. Before transfer, AirBEAM Smart checks and compares package version, so that only updated packages are loaded.

AirBEAM Smart resides on radio-equipped client devices and allows them to request, download and install software, as well as to upload files and status data. Both download and upload of files can be accomplished in a single communications session. The ability to transfer software over a radio network can greatly reduce the logistical efforts of client software management.

In an AirBEAM Smart system, a network-accessible host server acts as the storage point for the software transfer. The AirBEAM Smart Client uses the industry standard FTP or TFTP file transfer protocols to check the host system for updates and, if necessary, to transfer updated software.

NOTE: For more detailed information about AirBEAM, refer to the AirBEAM® Smart Windows® CE Client Product Reference Guide.

AirBEAM Package Builder

In a typical distributed AirBEAM system, software to be transferred is organized into packages. In general, an AirBEAM package is simply a set of files that are assigned attributes both as an entire package and as individual component files. The package is assigned a version number and the transfer occurs when an updated version is available.

An AirBEAM package can optionally contain developer-specified logic to be used to install the package. Installation logic is typically used to update client device flash images or radio firmware. Examples of common AirBEAM packages would include packages for custom client application software, radio firmware and AirBEAM Smart Client software.

Once these packages are built, they are installed on the host server for retrieval by the handheld device. The AirBEAM Package Builder is a utility used to define, generate and install AirBEAM packages to a server. The packages are then loaded from the server onto a client device equipped with an AirBEAM Smart Client executable.

For detailed instructions on how to define, generate and install AirBEAM packages to the server, refer to the *AirBEAM Package Builder Product Reference Guide*.

AirBEAM Smart Client

The AirBEAM Smart Client is installed on the handheld. It is configured with the server access information, the names of the packages to be downloaded and other controlling parameters. When the AirBEAM Smart Client is launched, the device connects to the specified FTP server and checks the packages it is configured to look for. If the package version was updated, the client requests the transfer.

AirBEAM License

The AirBEAM Smart Client is a licensed software product. The AirBEAM Smart Client's version synchronization functionality is enabled through a license key file that is stored on the client device. The license key file can be built into AirBEAM Smart Client's image, or downloaded in a special AirBEAM package.

The AirBEAM license key file contains a unique key and a customer specific banner that is displayed when the AirBEAM Smart Client version synchronization logic is invoked.

9 Using MC35 Companion Programs

Product download-related programs

To open AirBEAM:

- Tap  > Programs  > AirBEAM Client .

Configuring the AirBEAM Smart Client

Using the Configure command you can set preference settings on how to use AirBEAM. You can perform the following configuration options in AirBEAM:

- Specify the package name of the first four of eight packages that are to be loaded during the AirBEAM synchronization process. The specified package name must correspond to a package that is available on the specified package server.
- Specify the package name of the last four of eight packages that are to be loaded during the AirBEAM synchronization process. The specified package name must correspond to a package that is available on the specified package server.
- Specify the configurations of the server to which the client connects during the package synchronization process.
- Set various miscellaneous AirBEAM features.

To configure AirBEAM Smart Client:

- 1 Tap  > Programs  > AirBEAM Client .



- 2 Tap **File > Configure**.

The **Configuration** screen has seven tabs that you can modify - Packages(1), Packages(2), Server, Misc(1), Misc(2), Misc(3), and Misc(4).

NOTE: No inadvertent trailing spaces should be entered on the seven tabs. Information entered in these fields are case and space sensitive.

9 Using MC35 Companion Programs

Product download-related programs

- 3 On the Packages(1) tab, set the following options:

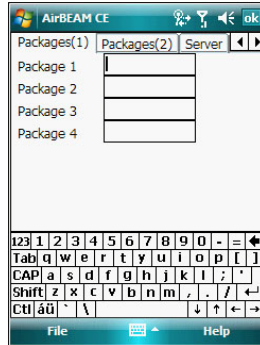

- In the Package 1 field, enter the package name of the first of eight packages.
- In the Package 2 field, enter the package name of the second of eight packages.
- In the Package 3 field, enter the package name of the third of eight packages.
- In the Package 4 field, enter the package name of the fourth of eight packages.

NOTE: Package 1 to Package 4 fields are optional fields.

- 4 Tap Packages(2) tab, then set the following options:

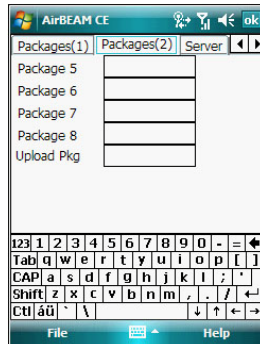

- In the Package 5 field, enter the package name of the fifth of eight packages.
- In the Package 6 field, enter the package name of the sixth of eight packages.
- In the Package 7 field, enter the package name of the seventh of eight packages.
- In the Package 8 field, enter the package name of the eighth of eight packages.
- In the Upload Pkg field, enter the name of a package that is to be processed for upload files during the AirBEAM synchronization process. The specified package name must correspond to a package that is available on the specified package server.

9 Using MC35 Companion Programs

Product download-related programs

NOTE: Package 5 to Package 8 and Upload Pkg fields are optional fields.

- 5 Tap **Server** tab, then set the following options:

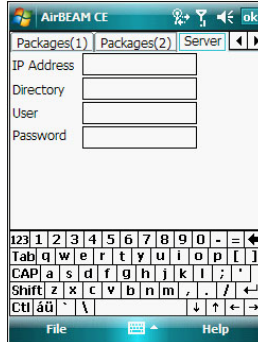

- In the **IP Address** field, enter the IP address of the server. It may be a host name or a dot notation format.
 - In the **Directory** field, enter the directory on the server that contains the AirBEAM package definition files. All AirBEAM package definition files are retrieved from this directory during the package synchronization process.
 - In the **User** field, enter the FTP user name that is used during the login phase of the package synchronization process.
 - In the **Password** field, enter the FTP password that corresponds to the FTP user specified in the User field. The specified password is used during the login phase of the package synchronization process.
- 6 Tap **Misc(1)** tab, then set the following options:

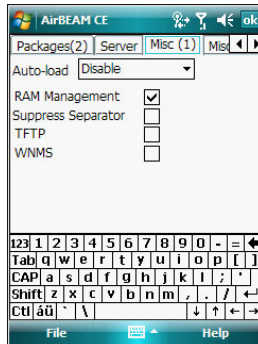

- In the **Auto-load** drop-down list, specify how the AirBEAM Smart Client is to be invoked automatically when the client device is rebooted. The selections include:
 - **Disable** - The AirBEAM Smart Client is not invoked automatically during the boot sequence.
 - **Interactive** - The AirBEAM Smart Client is invoked automatically during the boot sequence. The package synchronization process is started automatically. The Synchronization Dialog box appears and the user is required to press the OK button when the process is complete.

9 Using MC35 Companion Programs

Product download-related programs

- Non-interactive - The AirBEAM Smart Client is invoked automatically during the boot sequence. The package synchronization process is started automatically. The Synchronization Dialog box is displayed, but the user is not required to select OK when the process is complete. The Synchronization Dialog box terminates automatically.
- Background - The AirBEAM Smart Client is invoked automatically during the boot sequence. The package synchronization process is started automatically. Nothing is displayed while the synchronization process is occurring.

- Tap the "RAM Management" check box to specify whether the automatic RAM management is enabled during the package synchronization process.

If **enabled**, RAM management logic is invoked when there is not enough free disk space to download a package. The RAM management logic attempts to remove any disposable AirBEAM packages resident on the client.

- Tap the "Suppress Separator" check box to specify whether the automatic insertion of a file path separator character should be suppressed when the client generated server package definition file names.

When **enabled**, the parameter also disables the appending of .apd to the package. This feature is useful for AS/400 systems, in which the file path separator character is a period. When this feature is enabled, the server directory (Directory) and package name (Package 1, Package 2, Package 3 and Package 4) are appended "as is" when building the name for the server package definition file.

When this feature is **disabled**, a standard file path separator is used to separate the server directory (Directory) and package name (Package 1, Package 2, Package 3 and Package 4) when building the name for the server package definition file. In addition, an .apd extension is appended automatically.

- Tap the "TFTP" check box to specify whether the TFTP protocol is to be used to download files. By default, the AirBEAM Smart Client uses the FTP protocol.
- Tap the "WNMS" check box to specify whether the AirBEAM Smart Client uploads a WNMS information file at the end of each version synchronization.

- 7 Tap **Misc(2)** tab, then set the following options:



- In the Auto-retry field, specify whether the AirBEAM Smart Client automatically retries if there is a failure during the synchronization process.

If this feature is **enabled**, the AirBEAM Smart Client displays a popup dialog indicating the attempt of a retry. The popup dialog is displayed for the number of seconds specified in the Retry Delay field.

The valid values for this field are:

- -1: The AirBEAM Smart Client automatically retries indefinitely.
- 0: The AirBEAM Smart Client does not automatically retry.
- > 0: The AirBEAM Smart Client automatically retries up to the number of times specified.

9 Using MC35 Companion Programs

Product download-related programs

- In the **Retry Delay** field, specify the amount of time, in seconds, that the AirBEAM Smart Client delays before automatically retrying after a synchronization failure.
 - Tap the "In-use Test" check box to specify whether the AirBEAM Smart Client tests to determine if a file is in-use before downloading.
If the In-use Test feature is **enabled**, the AirBEAM Smart Client downloads a temporary copy of any files that are in-use. If any **temporary in-use files** are downloaded the AirBEAM Smart Client automatically resets the client to complete the copy of the in-use files. If the In-use Test feature is **disabled**, the synchronization process fails (-813) if any download files are in-use.
 - Tap the "Wait Welcome" check box to specify whether the AirBEAM Smart Client waits for the WELCOME windows to be completed before automatically launching the synchronization process after a reset.
 - Tap the "Close Apps" check box to specify whether the AirBEAM Smart Client automatically attempts to close non-system applications prior to resetting the mobile unit. If **enabled** the AirBEAM Smart Client sends a WM_CLOSE message to all non-system applications before resetting the mobile unit. This feature offers applications the opportunity to prepare (i.e. close open files) for the pending reset.
- 8 Tap **Misc(3)** tab, then set the following options:

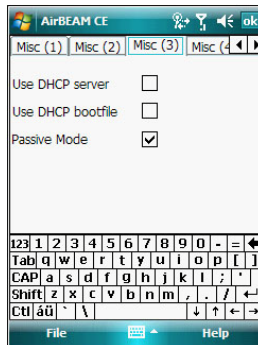

- Tap the "Use DHCP server" check box to specify whether the AirBEAM Smart Client uses the DHCP response option 66 to specify the IP address of the FTP/TFTP server.
- Tap the "Use DHCP bootfile" check box to specify whether the AirBEAM Smart Client uses the DHCP response option 67 to specify the Package and Package 1 parameters.
- Tap the "Passive Mode" check box to specify whether the Client uses passive mode FTP. This setting is ignored if TFTP protocol is used.

9 Using MC35 Companion Programs

Product download-related programs

- 9 Tap **Misc(4)** tab, then set the following options:

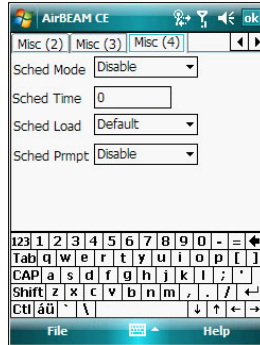

- In the **Sched Mode** drop-down list, specify whether (and how) the scheduled mode is enabled. If enabled, schedule mode causes the AirBEAM synchronization process to occur periodically. The selections include:
 - **Disable** - The schedule mode is disabled.
 - **Fixed time** - The schedule mode is enabled. The AirBEAM synchronization will be launched once per day at the time specified in the Sched Time setting. The synchronization will be launched every day Sched Time minutes past midnight.
 - **Fixed period** - The schedule mode is enabled. The AirBEAM synchronization will be launched at a period by the Sched Time setting. The synchronization will be launched every Sched Time minutes.
- In the **Sched Time** field, specify, in minutes, the period for the schedule mode. The Sched Mode setting specifies how the Sched Time value is used.
- In the **Sched Load** drop-down list, specify the load mode to be used for scheduled synchronization, if enabled. The selections include:
 - **Default** - Specifies that the load mode specified in the Auto-load setting is to be used for scheduled synchronization sessions.
 - **Interactive** - The Synchronization Dialog displays when a scheduled synchronization session occurs. The user is required to press the OK button to dismiss the dialog.
 - **Non-interactive** - The Synchronization Dialog displays when a scheduled synchronization session occurs. The dialog is automatically dismissed when the synchronization is complete, unless an error occurs. If an error occurs the user is required to press the OK button to dismiss the dialog.
 - **Background** - Nothing is displayed when the scheduled synchronization sessions occur.
- In the **Sched Prompt** drop-down list, specify whether the AirBEAM client prompts the user when updates are available in schedule mode. The settings include:
 - **Disable** - Updated packages are automatically downloaded. The user is not prompted.
 - **Alert** - Updated packages are not automatically downloaded. The user is prompted to warm boot the device to initiate the package downloads.
 - **Launch** - Updated packages are not automatically downloaded. The user is prompted to start the package download. The user can defer the package download by responding no to the prompt. The MAXNOPRESS registry setting can be used to limit the number of times the user can defer the update.
 - **Confirm** - Updated packages are not automatically downloaded. This value behaves the same as the Launch value, except that the user is required to confirm an additional prompt before the download starts.

Synchronizing with the server

When the synchronization process is initiated, the AirBEAM Smart Client attempts to open an FTP session using the AirBEAM Smart Client configuration. Once connected, the client processes the specified packages. Packages are loaded only if the server version of a given package is different from the version loaded on the client. Once the upload process is complete, the AirBEAM Smart Client closes the FTP session with the server.

The AirBEAM Smart Client can launch an FTP session with the server either manually, when initiated by the user, or automatically.

Manual synchronization

- 1 Configure the AirBEAM Smart Client. See "Configuring the AirBEAM Smart Client" on page 194 for more information.
- 2 From the main *AirBEAM CE* screen, tap **File**, then **Synchronize**.

Once connected, the AirBEAM Synchronize screen appears.

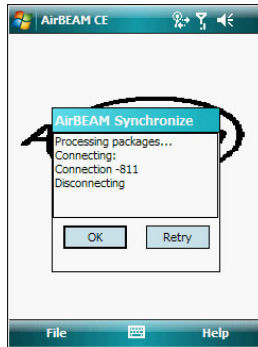

- The **Status List** displays status messages that indicate the progress of the synchronization process.
- Press **Enter** to return to the Main Menu. This button remains inactive until the synchronization process is complete.
- Select **Retry** and press **ENTER** to restart the synchronization process. This button is activated only if there is an error during the synchronization process.

Automatic synchronization

The AirBEAM Smart Client can be configured to launch automatically using the Misc(1) tab (see Misc(1) on page 196). When setting automatic synchronization, use the Auto-load drop-down list to specify how the AirBEAM Smart Client should be invoked automatically when the client device is rebooted. See Misc(1) on page 196 for instructions on enabling Auto Sync.



RD Client Version

The RD Client version enables simple and rapid provisioning of new (out of the box) mobile devices and simplifies the out-of-box provisioning by scanning bar codes or connecting to a profile server. The RD Client acts as a frontend for wireless radio configuration, automating the manual configurations that would normally be required to use these tools.

NOTE: The MSP 3.X Rapid Deployment Client enables staging by scanning staging profiles encoded into staging bar code sheets. It also enables staging to be performed without scanning bar codes through the use of On-Demand Staging. When using On-Demand Staging, the RD Client pulls staging profiles directly from an On-Demand Profile Server over some form of pre-configured or automatically-configured IP connection. For detailed information about the MSP 3.X, refer to the Mobility Services Platform 3.X User's Guide.

An MSP Administrator uses the MSP Console for the creation of an RD profile that contains all the wireless network and security information (for example, ESSID, WEP Keys, etc.) required to get a mobile device onto the wireless network. The profile also contains FTP server access information needed to connect to the provisioning MSP and the list of software packages to be provisioned to the mobile device from the provisioning MSP. The RD profile can then be encoded into an RD bar code sheet and printed from the MSP Console or loaded onto a profile server.

RD bar code print out sample

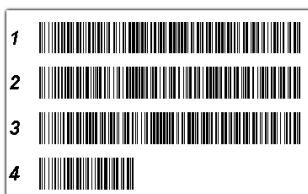

Bar code scanning

The Rapid Deployment window displays bar code scan status and provides features for resetting and exiting the application.

To access the Rapid Deployment window tap  > **Programs**  > **Rapid Deployment**

Client .

The Rapid Deployment window displays bar code scan status and provides features for resetting and exiting the application.

9 Using MC35 Companion Programs

Product download-related programs

To access the Rapid Deployment window:

NOTE: Ensure that the CamWedge 'Send ENTER key after suffix' option is enabled. Refer to step 2 on page 190.

1 Obtain the appropriate RD bar code sheet from the [MSP Administrator](#).

2 Tap  > **Programs**  > **Rapid Deployment Client** .

The SCAN BARCODES TO DEPLOY window displays.

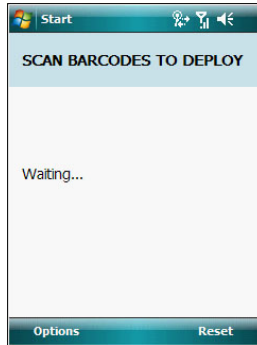

The RD Client waits for the first bar code scan.

3 Scan the first bar code. The window indicates which bar code to scan next.

NOTE: Multi-part linear bar codes (1-D bar codes) can require scanning several bar codes. Bar codes can be scanned in any order. The display indicate the bar code to scan.

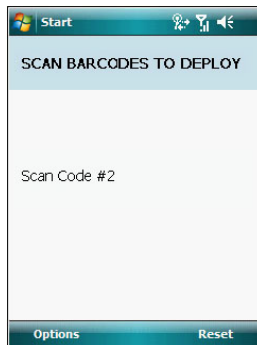

- 4 After all the bar codes are scanned successfully, the device connects to the server and the PROCESSING PROFILE window displays while network settings are configured.

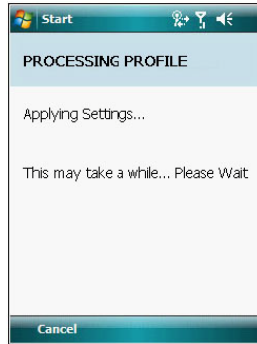

- 5 When staging is complete the STAGING COMPLETE window displays.

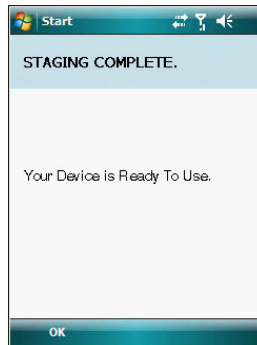

- 6 Press the **left** soft button to exit the RD Client.

On-Demand Staging

The MSP 3.X RD Client also enables staging without having to scan bar codes through the use of On-Demand Staging (Electronic Staging).

When using On-Demand Staging, the RD Client pulls staging profiles directly from an On-Demand Profile Server over some form of pre-configured or automatically-configured IP connection. The following types of IP connection modes are currently supported for Electronic Staging:

- ActiveSync connection mode - This mode uses the IP connection that is established when the device is directly connected (via a USB cable, serial cable or cradle) to a host computer running ActiveSync. The most common scenario would be where the On-Demand Profile Server is running on the host computer to which the device is connected via ActiveSync. It would, however, also work with the On-Demand Profile Server running on any other host computer that is on the same subnet as the host computer to which the device is connected via ActiveSync.

9 Using MC35 Companion Programs

Product download-related programs

- **Already existing IP connection mode** - This mode uses any IP connection that is already active on the device. This could be a direct Ethernet port (if available), or a WLAN connection that was configured and established before the RD Client was launched. It could also be any other form of IP connection that might be available on the device. The RD Client does not do anything to configure or establish such connections, but uses them if they exist. The On-Demand Profile Server must be running on a host computer that is on the same subnet that is accessible from the connection.
- **Well-known WLAN connection mode** - This mode works only on supported Zebra WLAN adapters. The RD Client attempts to configure and establish WLAN IP connections using pre-defined Zebra WLAN settings. If the RD Client is able to successfully configure and establish such a connection, and if an On-Demand Profile Server is running on a host computer that is on the same subnet that is accessible from the connection, then Electronic Staging proceeds using that connection.

To perform On-Demand Staging:

- 1 In the **App Launcher** menu, press the joystick to launch the RD Client. The **SCAN BARCODES TO DEPLOY** window displays.

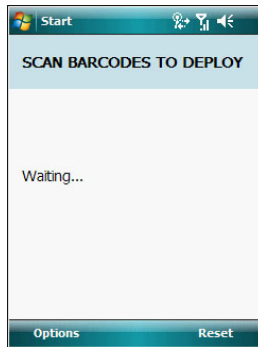

- 2 Press the left soft button to select **Options**. The **MAIN MENU** window appears.

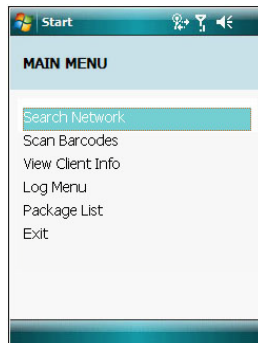

- 3 Move the joystick up/down to select **Search Network** and then press the joystick. The SEARCHING NETWORKS window appears.

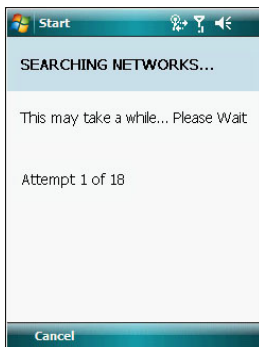

- 4 When complete, the STAGING COMPLETE window displays.

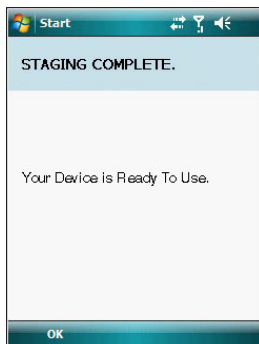

- 5 Press the left soft button to exit.

9 Using MC35 Companion Programs

Product download-related programs

RD Client Main Menu

The RD Client Main Menu contains the following options:

- Search Network. See "On-Demand Staging" on page 203 for detailed information.
- Scan Barcodes. See "Bar code scanning" on page 201 for detailed information.
- View Client Info
- Log Menu
- Package List
- Exit - Closes the RD Client application.

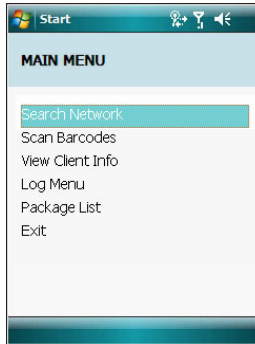

Client Info

Use the Client Info window to view the following information:

- RD Client version
- Product name
- Operating system type
- Plug-in type

- 1 On the **MAIN MENU**, tap the **View Client Info** option.

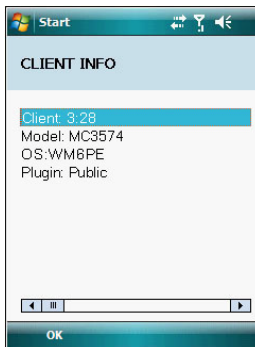

- 2 Tap **OK** to return to the **MAIN MENU**.

Log Menu

The Log Menu contains the following options:

- View Log
 - View Job Log
 - Set Log Level
 - Set Job Log Level
- 1 On the **MAIN MENU**, select the **Log Menu** option.

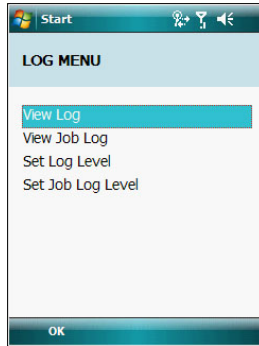

- 2 Tap **OK** to return to the **MAIN MENU**.

View Log

Use the View Log option to display a list of events that have occurred.

- 1 On the **LOG MENU**, select the **View Log** option.

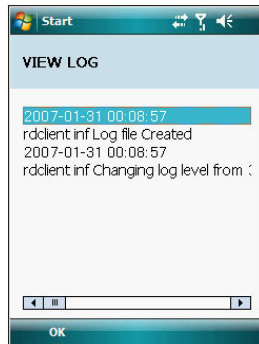

- 2 Tap **OK** to return to the **LOG MENU**.

9 Using MC35 Companion Programs

Product download-related programs

View Job Log

Use the View Job Log option to display a list of jobs that have been processed.

- 1 On the **LOG MENU**, select the **View Job Log** option.

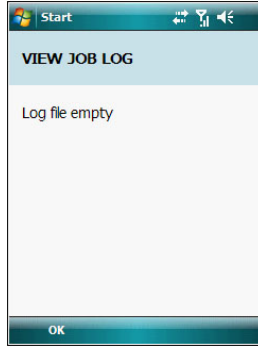

- 2 Tap **OK** to return to the **LOG MENU**.

Set Log Level

Use the Set Log Level option to set the level of the information that appears in the log.

- 1 On the **LOG MENU**, select the **Set Log Level** option.

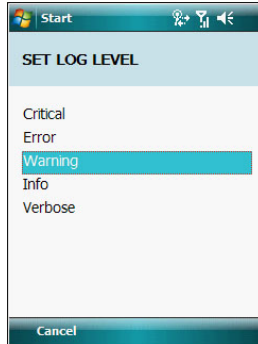

- 2 Select a level option.

Set Job Log Level

Use the Set Job Log Level option to set the level of the information that appears in the Job log.

- 1 On the LOG MENU, select the **Set Job Log Level** option.

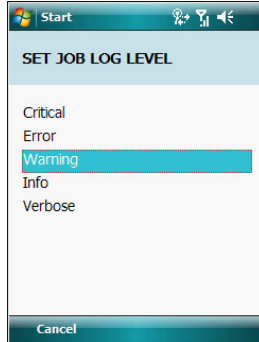

- 2 Select a level option.

Package List

Use the Package List option to display the packages that have been installed on the device.

- 1 On the MAIN MENU, select the **Package List** option.

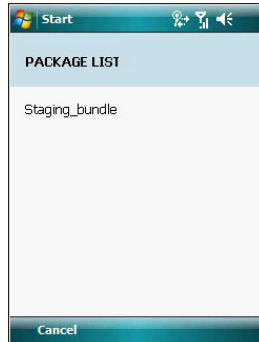

- 2 Tap **OK** to return to the MAIN MENU.

MSP Agent

NOTE: MSP Agent is also known as MSP 3.X Provisioning Client.

The Provisioning Client replaces AirBEAM Client and is responsible for implementing device-side provisioning activities as defined by a policy. A policy is evaluated on the MSP 3.X system and delivered to devices as job documents via relay servers.

The MSP 3.X Provisioning Client is 100% backward compatible to prior versions of the AirBEAM Client. Existing AirBEAM Smart users can use the MSP 3.X Provisioning Client as a 100% backward compatible replacement for prior versions of AirBEAM client, when used in Classic AirBEAM mode with existing FTP servers.

Existing MSP 2.X users can use the new Provisioning Client as a 100% backward compatible replacement for previous versions of AirBEAM Client, when used in Level 2 Agent and Level 3 Agent modes with existing MSP 2.X Appliances.

For more detailed information on MSP Agent (Provisioning Client), refer to the *MSP 3.X User's Guide* (p/n 72E-100158-xx).

To open MSP Agent:

- Tap  > **Programs**  > **MSP Agent** . The MAIN MENU window displays.

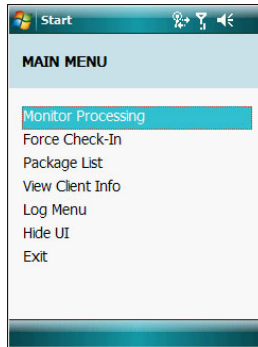

MSP Agent Main Menu

The MSP Agent Main Menu contains the following options:

- Monitoring Processing
- Force Check-In
- Package List
- View Client info
- Log Menu
- Hide UI
- Exit - Closes the MSP Agent application.

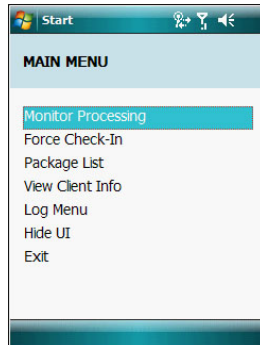

Monitor Processing

Use the Monitor Processing option to view the status of packages being processed.

- 1 On the **MAIN MENU**, select the **Monitor Processing** option.

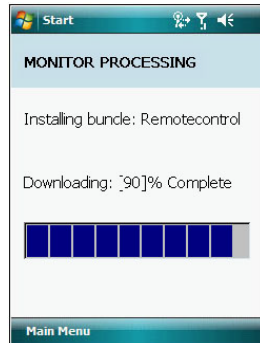

- 2 Tap **OK** to return to the **MAIN MENU**.

9 Using MC35 Companion Programs

Product download-related programs

Force Check-In

Use the Force Check-In option to check instantly for pending package downloads instead of waiting for the next automatic check that the client performs.

- 1 On the MAIN MENU, select the **Force Check-In** option.

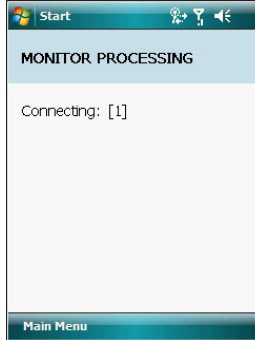

- 2 Tap **OK** to return to the MAIN MENU.

Package List

Use the Package List option to display the packages that have been installed on the device.

- 1 On the MAIN MENU, select the **Package List** option.

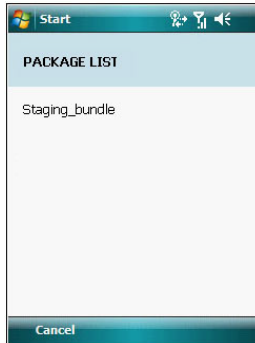

- 2 Tap **OK** to return to the MAIN MENU.

Client Info

Use the Client Info window to view the following information:

- RD Client version
 - Product name
 - Operating system type
 - Plug-in type
- 1 On the **MAIN MENU**, select the **View Client Info** option.

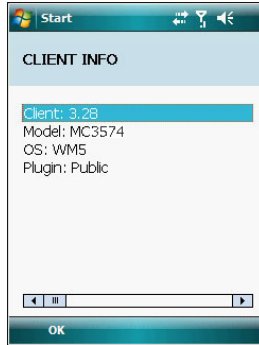

- 2 Tap **OK** to return to the **MAIN MENU**.

Log Menu

The Log Menu contains the following options:

- View Log
 - View Job Log
 - Set Log Level
 - Set Job Log Level
- 1 On the **MAIN MENU**, select the **Log Menu** option.

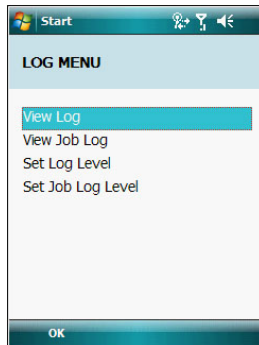

- 2 Tap **OK** to return to the **MAIN MENU**.

9 Using MC35 Companion Programs

Product download-related programs

View Log

Use the View Log option to display a list of events that have occurred.

- 1 On the **LOG MENU**, select the **View Log** option.

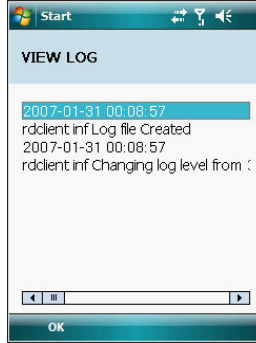

- 2 Tap **OK** to return to the **LOG MENU**.

View Job Log

Use the View Job Log option to display a list of jobs that have been processed.

- 1 On the **LOG MENU**, select the **View Job Log** option.

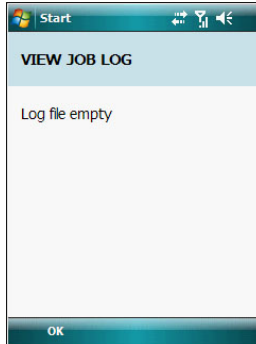

- 2 Press the left soft button to return to the **LOG MENU**.

Set Log Level

Use the Set Log Level option to set the level of the information that appears in the log.

- 1 On the LOG MENU, select the **Set Log Level** option.

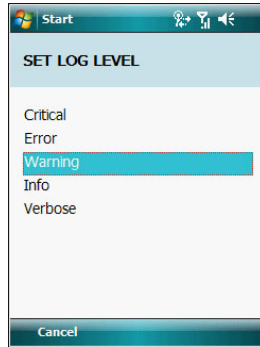

- 2 Select a level option.

Set Job Log Level

Use the Set Job Log Level option to set the level of the information that appears in the Job log.

- 1 On the LOG MENU, select the **Set Job Log Level** option.

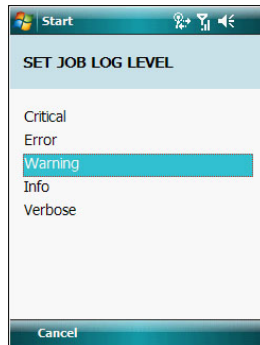

- 2 Select a level option.

9 Using MC35 Companion Programs

Product download-related programs

Hide UI

Use the Hide UI option to minimize the MSP Agent application. The MSP Agent application runs in the background while minimized.

To un-hide the application:

- On the Today screen, tap and hold the MSP Agent icon  located on the lower right corner of the screen and select the **UnHide UI** menu item.





Certificate Import

Use the Certificate Import utility to import personal certificates. Personal certificates need to be in PKCS#12 format and have the extension .pfx or .p12. PKCS#12 files typically contain a personal certificate and its corresponding private key, a root certificate and optionally a number of intermediate CA certificates. Digital certificates are used to encrypt SSL connections to websites and to allow you to use Exchange ActiveSync.

To open Certificate Import:

- Tap > **Programs** > **Certificate Import** .

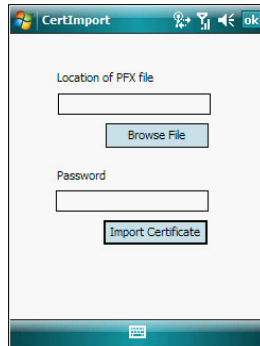

To install a digital certificate to your device:

- 1 Download the digital certificate to your computer.
- 2 Using ActiveSync, copy the digital certificate to your device.
- 3 Launch the **Certificate Import** application.
- 4 Tap **Browse File** to locate the file you want to import.
- 5 Enter the password that was used to encrypt the PKCS#12 file.
- 6 Tap **Import Certificate**.
- 7 Tap **ok**.

10 Customizing your MC35

- Adjusting system preferences
- Program management



Adjusting system preferences

You can adjust the settings of your device to suit the way you work. Adjusting certain settings, such as backlight, auto power off timer, system volume, and processor speed, from the factory default settings may decrease your standby time.

To access **Settings**:

- Tap  > **Settings** .

The Settings window has three tabs—Personal, System, and Connections, each of which has its own set of options.

The following sections show the configuration page for each Settings option. For detailed instructions on these pages, access the page from your device, tap  > **Help** .

Personal tab

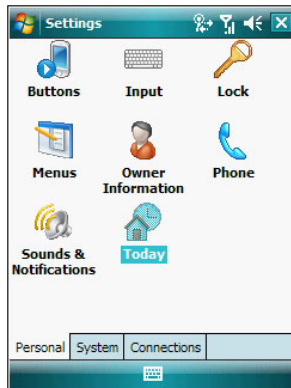

10 Customizing your MC35

Adjusting system preferences

Buttons

Assign the Send/End button on the stereo headset/single earbud headset to commonly-used programs. You can also adjust the on-screen scrolling speed here.

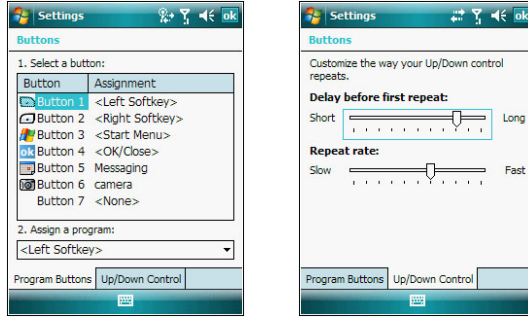

Input

Select an input method, options for word completion and other related settings.

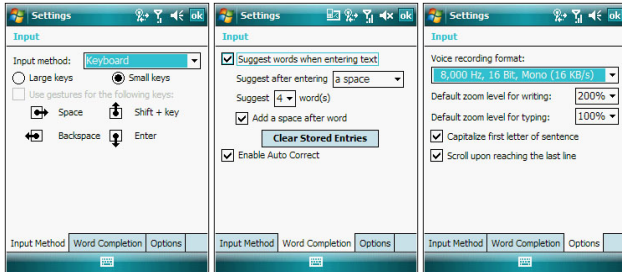

Lock

Set a password to prevent unauthorized access to your device. You also have the option to set a password hint to serve as a reminder in case you forget your password.

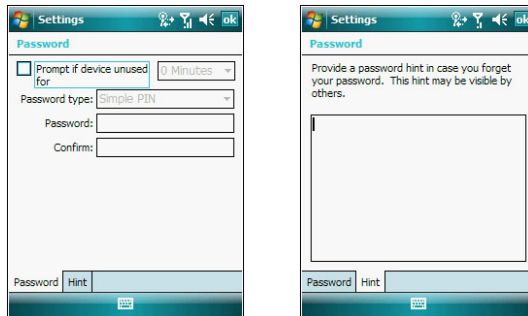

Menus

Customize what appears on the  menu.

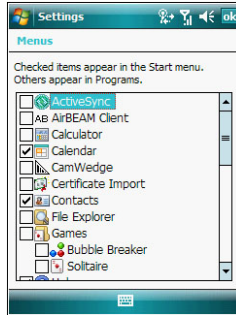

Owner Information

Enter personal information and customize text display when device is turned on.

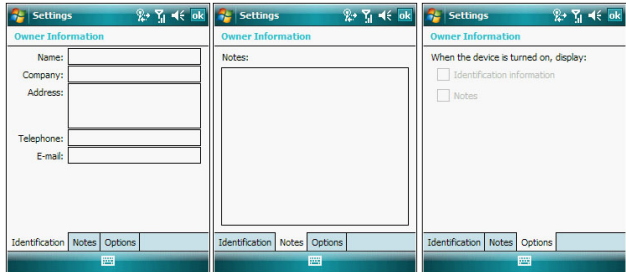

10 Customizing your MC35

Adjusting system preferences

Phone

Set up the phone function of your device. See "Phone preferences" on page 137 for more information.

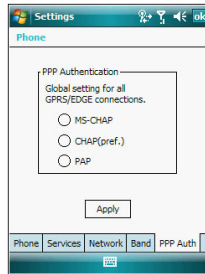
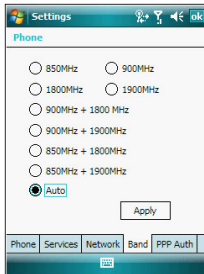
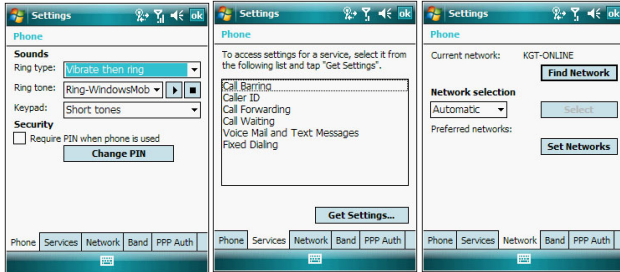

Sounds & Notifications

Set the volume level for system sounds and select the types of action you want to hear sounds for. You can also define how you want to be notified about different events. Options for personalizing sound notifications are also available.

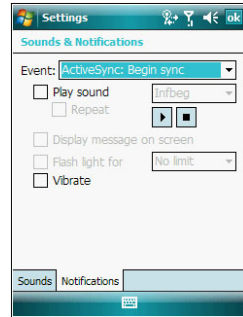
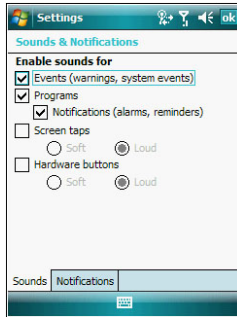

Today

Customize the look and the information that is displayed on the Today screen.

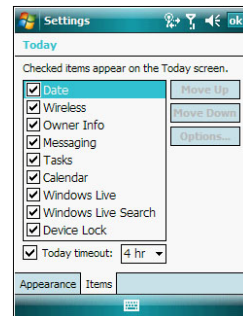
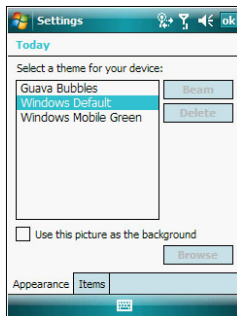

10 Customizing your MC35 *Adjusting system preferences*

System tab

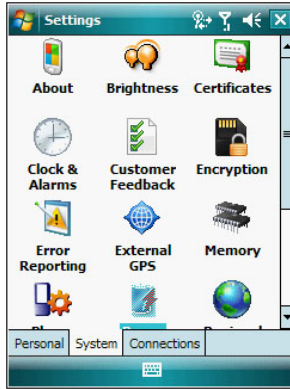

About

Displays your device's version and copyright information; includes an option to define a device ID.

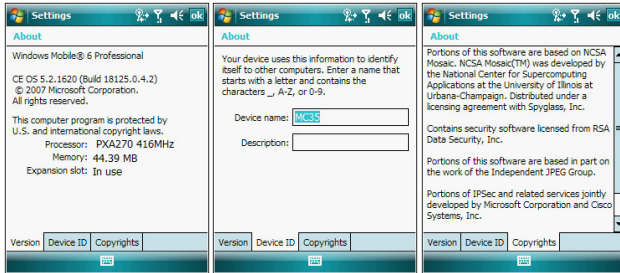

Brightness

Define settings for the display brightness and backlight control.

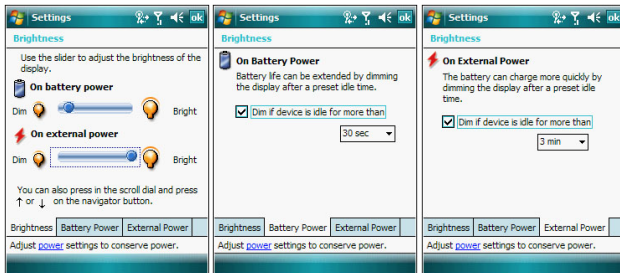

Certificates

View and manage the public key certificates available on your device.

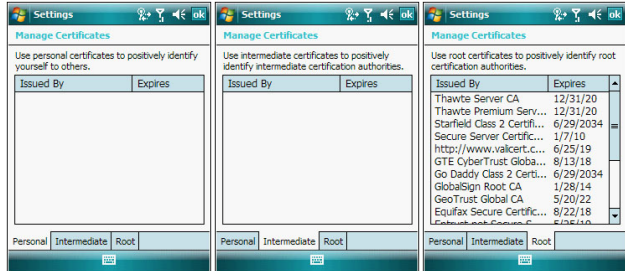

Clock & Alarms

Change the time or set alarms.

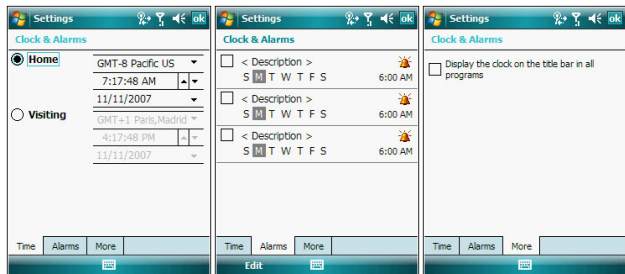

Customer Feedback

Submit your feedback on the Windows Mobile 6.0 software.

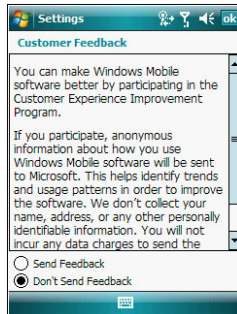

10 Customizing your MC35

Adjusting system preferences



Encryption

Enables or disables encrypting files stored in your memory card.

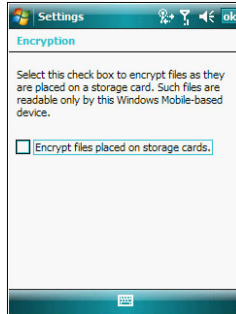

Error reporting

Enable or disable error reporting.

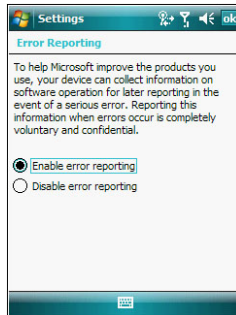

External GPS

Adjust the GPS settings.

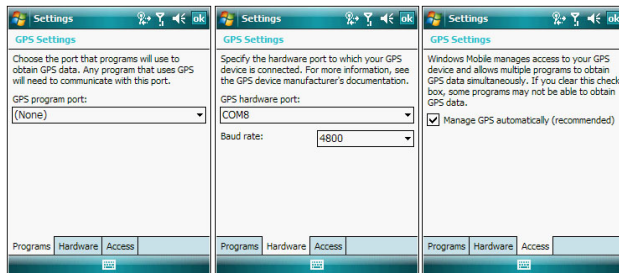

Memory

Adjust allocation of storage and main memory.

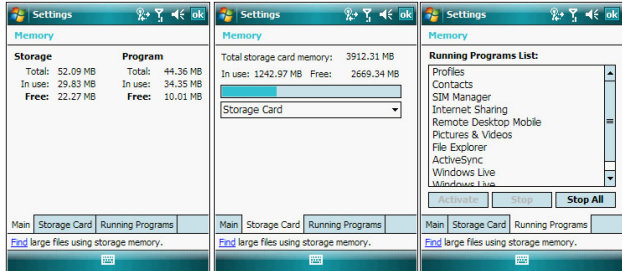

Phone Profiles

View and edit the Phone function's preset profiles for different operations mode.

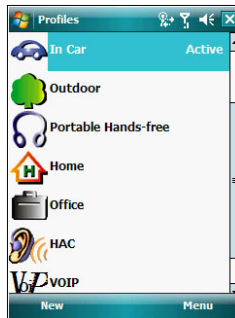

10 Customizing your MC35 Adjusting system preferences

Power

View power level for the main battery. To minimize power consumption, you can define settings for the auto-off function and the processor's operation speed.

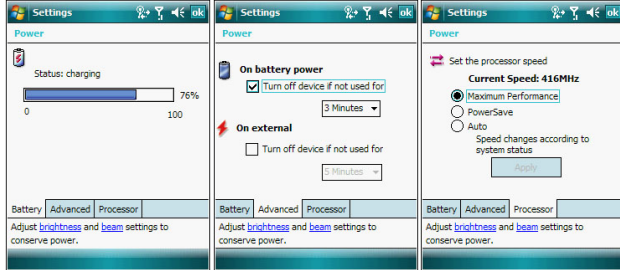

Regional Settings

Set default number and time display formats and other related options.

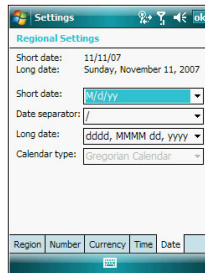
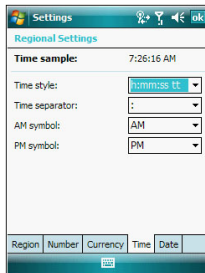
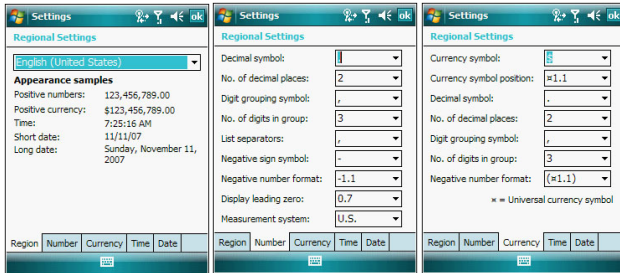

 **Remove Programs**

Remove programs from storage memory.

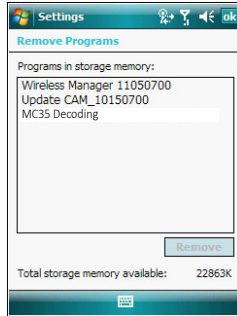

 **Screen**

Set the viewing orientation and text size setting. You can also recalibrate screen and enable the ClearType feature.

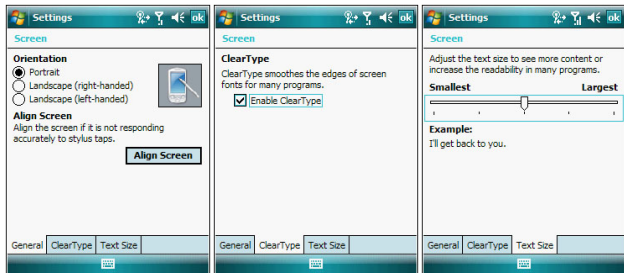

10 Customizing your MC35

Adjusting system preferences

SDSwitch

Switch between SDIO and SDMMC driver mode. When you want to run applications from an SD card, it is recommended to switch the SD driver mode from the default SDIO mode to SDMMC mode to improve the performance of the SD cards. If you are not going to launch applications from an SD card, keep the default SD driver mode settings to SDIO mode.

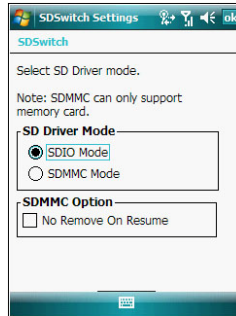

NOTE: The "No Remove On Resume" option in the SDSwitch Settings screen is primarily applicable when you select the SDMMC driver mode. It prevents the SDMMC driver to unload or reload when device resumes operation.

SIM Manager

Manage all contacts stored on your SIM card.



System Information

Displays your device's hardware and software information.

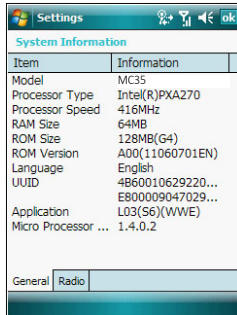

Windows Update

Keep your device up to date by downloading security fixes, critical updates, drivers, and latest Help files.

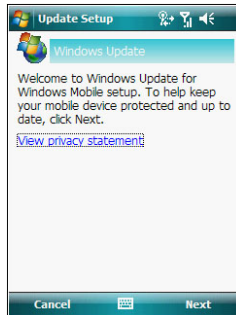

Connections tab

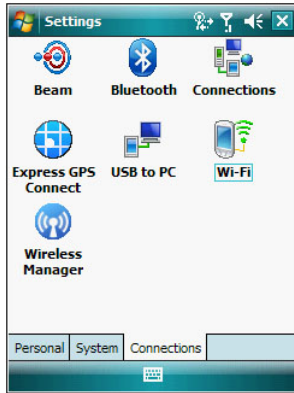

Beam

Define settings for the beam function.

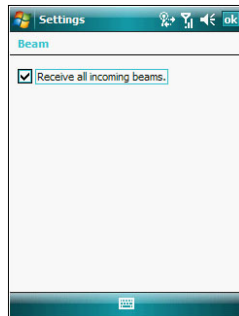

Bluetooth

Use this option to configure the device's Bluetooth settings.

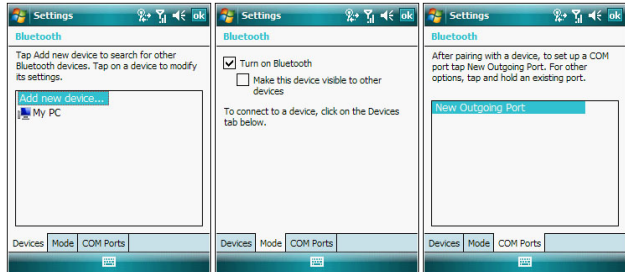

Connections

Adjust settings for connecting to your ISP or to a local network.

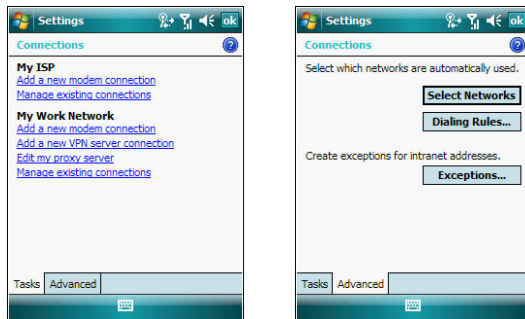

Express GPS Connect

Enable and customize settings for the GPS connection utility.

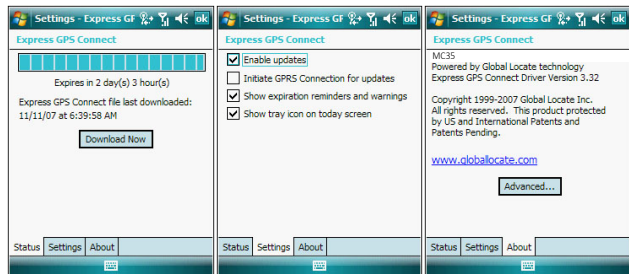

10 Customizing your MC35

Adjusting system preferences

USB to PC

Enable or disable the enhanced network connectivity.

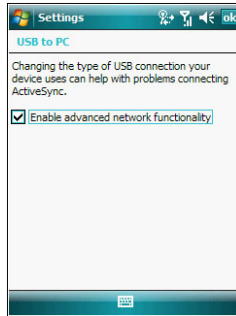

Wi-Fi/Network Cards

Setup wireless network connection or customize settings for your device's network adapter.

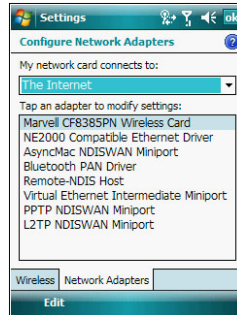
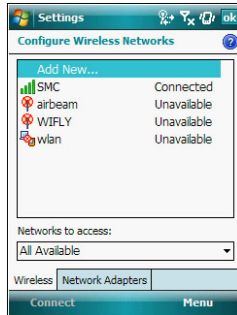

Wireless Manager

Enable or disable the device's wireless radios and customize Wi-Fi, Bluetooth, and Phone settings.

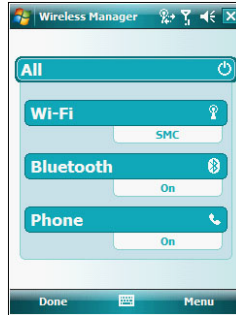



Program management

Adding programs to your device

Programs bundled with your device at the factory are stored in ROM (read-only memory). You cannot remove these programs, and you'll never accidentally lose ROM contents. ROM programs can be updated using special installation programs with a *.xip extension. All other programs and data files installed to your device after factory installation are stored in the Random Access Memory (RAM). You can install any program created for your device, as long as it has enough memory. The most popular place to find software for your device is on the Windows Mobile Web site <http://www.microsoft.com/windowsmobile/default.msp>. You can add programs to your device either by using ActiveSync or by downloading the program from the Internet.

To add programs using ActiveSync:

Before installing a program on your device, you must first install the appropriate software for your device on your computer.

- 1 Determine your device and processor type so that you know which version of the software to install.
 - (a) Tap  > **Settings** .
 - (b) On the System tab, tap **About** .
 - (c) On the Version tab, make a note of the processor information.
- 2 Download the program to your computer (or insert the CD or disk that contains the program into your computer).



You may see a single *.xip, *.exe, or *.zip file, a Setup.exe file, or several versions of files for different device types and processors. Be sure to select the program designed for a Pocket PC and your device's processor type.

NOTE: Read any installation instructions, Readme files, or documentation that come with the program. Many programs provide special installation instructions.

- 3 Connect your device to your computer.



10 Customizing your MC35

Program management

- 4 Double-click the *.exe file.
 - If the file is an installer, the installation wizard will begin. Follow the directions on the screen. Once the software has been installed on your computer, the installer will automatically transfer the software to your device.
 - If the file is not an installer, you will see an error message stating that the program is valid but it is designed for a different type of computer. You will need to move this file to your device. If you cannot find any installation instructions for the program in the Readme file or documentation, use the ActiveSync Explore button to copy the program file to the Program Files folder on your device. For more information on copying files using ActiveSync, see page 37.
- 5 Once installation is complete, tap  > **Programs** , then the program icon to launch it.

To add a program directly from the Internet:

- 1 Determine your device and processor type so that you know which version of the software to install.

- (a) Tap  > **Settings** .
- (b) On the System tab, tap **About** .
- (c) On the Version tab, make a note of the processor information.

- 2 Download the program to your device straight from the Internet using Internet Explorer Mobile.

You may see a single *.xip, *.exe or *.zip file, a Setup.exe file, or several versions of files for different device types and processors. Be sure to select the program designed for a Pocket PC and your device's processor type.



NOTE: Read any installation instructions, Readme files, or documentation that comes with the program. Many programs provide special installation instructions.

- 3 Tap the file, such as a *.xip or *.exe file. The installation wizard will begin.
- 4 Follow the on-screen instructions.

Adding a program to the Start menu



You can choose what program icons should appear on the menu based on which ones you use most often.

To add a program to the Start menu program using Settings:

- 1 Tap  > **Settings** .
- 2 On the Personal tab, tap **Menus** .
- 3 Select the check box for the programs you wish to add.

If you do not see the program you want, you can either use File Explorer on your device to move the program to the Start Menu folder, or use ActiveSync on your computer to create a shortcut to the program and place the shortcut in the Start Menu folder.

To add a program to the Start menu program using File Explorer on your device:

- 1 Tap  > **Programs**  > **File Explorer** .
- 2 Tap the **My Device** icon (tap the folder list, labeled My Documents by default, and then My Device to see a list of all folders on your device).
- 3 Open the path: **Windows > Start Menu > Programs**.
- 4 Tap and hold the program you want to add to the menu, then tap **Cut** on the pop-up menu.
- 5 Open the path: **Windows > Start Menu**.
- 6 Tap and hold a blank area of the window, then tap **Paste** on the pop-up menu.
- 7 The program will now appear on the  menu.







To add a Start menu program using ActiveSync on your computer:

- 1 In the **ActiveSync** on your computer, click **Explore** to explore your device's files and locate the program.
- 2 Right-click the program, and then click **Create Shortcut**.
- 3 Move the shortcut to the **Start Menu** folder in the Windows folder.
The shortcut now appears on the  menu.
For more information on using ActiveSync, see **ActiveSync Help** on your computer.

Running programs from the SD card

Store applications in the SD card and launch directly from the card.



To run programs from an SD card:

- 1 Launch the SDSwitch application.
 - (a) Tap  > **Settings** .
 - (b) On the **System** tab, tap **SDSwitch** .
- 2 Set the SD driver mode to SDMMC mode. See "To set the SD driver mode to SDMMC mode" on page 238 for more information.
- 3 Insert the SD card into your device.
- 4 Tap  > **Programs**  > **File Explorer** .
- 5 Run the application stored in the SD card.

Removing programs

You can only remove programs that you installed. Programs that come with your device cannot be removed.

To remove a program using Settings:

- 1 Tap  > **Settings** .
- 2 On the **System** tab, tap **Remove Programs** .

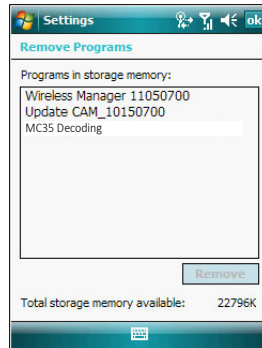



- 3 Tap the program you wish to remove.
- 4 Tap **Remove**.
- 5 Tap **Yes**. If another confirmation message appears, tap **Yes** again.

10 Customizing your MC35

SD driver management

To remove a program using File Explorer on your device:

If the program does not appear in the list of installed programs in Remove Programs, use File Explorer on your device to locate the program:



- 1 Tap  > **Programs**  > **File Explorer** .
- 2 Tap the **My Device** icon (tap the folder list, labeled My Documents by default, and then My Device to see a list of all folders on your device).
- 3 Open the path: **Windows > Start Menu > Programs**.
- 4 Tap and hold the program you want to remove, then tap **Delete** on the pop-up menu.

SD driver management

Setting the SD driver

The SDSwitch application supports two SD driver mode. The SDIO mode is enabled by default. Keep this setting when backing up or transferring files to a storage card. When you want to run applications from an SD card, you must set the SD driver mode to SDMMC mode to improve the performance of the SD card.

To set the SD drive mode to SDMMC mode:

- 1 Tap  > **Settings** .
- 2 On the **System** tab, tap **SDSwitch** .

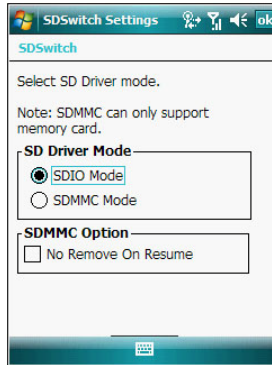

- 3 Select the **SDMMC Mode**.
- 4 Tap the "No Remove On Resume" check box.

- 5 Tap **ok**. A confirmation box is displayed.

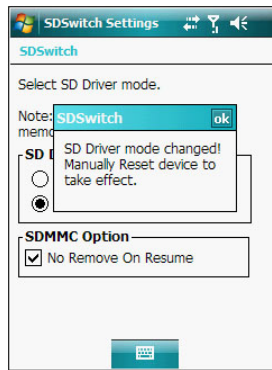

- 6 Tap **ok**, then perform a soft reset. See "To perform a soft reset" on page 251 for more information.

To set the SD drive mode to SDIO mode:



- 1 Tap > **Settings** .
- 2 On the System tab, tap **SDSwitch** .
- 3 Select the **SDIO Mode**.
- 4 Tap **ok**. A confirmation box is displayed.
- 5 Tap **ok**, then perform a soft reset. See "To perform a soft reset" on page 251 for more information.

11 User Support

- Customer support
- Protecting your MC35
- Troubleshooting

Customer support

Refer to following help resources on how to use your MC35.

For information on:	Refer to:
Operating instructions	This User Guide. It provides online reference for using your device. The guide is available for download. Visit http://www.zebra.com/support The MC35 Help. To view Help, tap  > Help  .
Programs on your device Additional programs that can be installed on your device	See "Program list" on page 40 for more information.
Up-to-date information regarding your device	For the latest information on the MC35 visit http://www.zebra.com/mc35
Technical assistance	Go to http://www.zebra.com/support to contact the Zebra Support for your region. If you purchased your Zebra product from a Zebra Business Partner, contact that Business Partner for service. Before contacting, have the model number and serial number at hand. If your problem cannot be solved by the Zebra Support, you may need to return your equipment for servicing and you will be given specific directions. Zebra is not responsible for any damages incurred during shipment if the approved shipping container is not used. Shipping the units improperly can possibly void the warranty.

Protecting your MC35

Your device is not just a financial investment but a wealthy source of personal information. It is then imperative that you protect your device from unauthorized access, as well as data loss.

Using system locks

There several ways that you can secure your MC35, both from accidental key presses and from unauthorized access.

- Locking the keypad
- Locking the touch screen
- Setting an access password lock

Locking the keypad/touch screen

Tapping the **Device unlocked** icon  on the Today screen prevents accidental data entry from both the keypad and the touch screen. When the device is locked, the command bar displays **Unlock**.

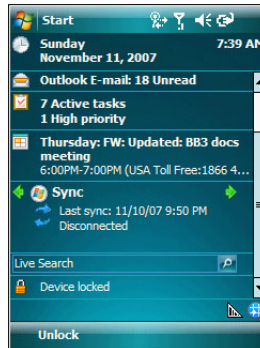

To unlock the keypad/touch screen:

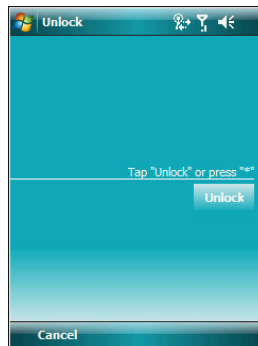

- 1 On the command bar, tap **Unlock**.
- 2 On the **Unlock** screen, tap **Unlock** or press the **orange** and **Q** keys on the keypad.



Locking the device

You have the option to create a lock password that will be required to access your device after a set period of inactivity.

To assign a lock password:

- 1 Tap  > **Settings** .
- 2 On the **Personal** tab, tap **Lock** .
- 3 On the **Password** tab, perform the following:

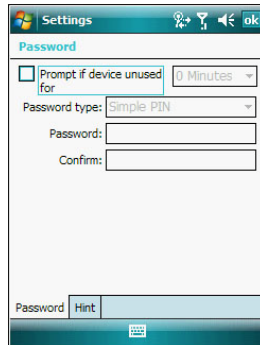

- (a) Select the "Prompt if device unused for" check box, then tap the pick list opposite it to set the period of inactivity before the lock password is required for access.
 - (b) Select a password type pick list. You have two options.
 - Simple PIN – This password mode requires a 4-digit password.
 - Strong alphanumeric – This password mode requires an alphanumeric password (i.e., a combination of upper- and lower case letters, numbers, and symbols) consisting of at least seven characters.
- 4 Type then confirm your lock password.
 - 5 If you want to set a keyword to serve as a password reminder in case you forget it, tap the **Hint** tab.
 - 6 Tap **ok**.

Creating backup files

Any additional programs or new data in your device are stored in the Random Access Memory (RAM). These items are lost if you have to perform a hard reset or your device loses all power for any other reason. Because of this, it is important that you regularly back up files to your computer via ActiveSync or to a storage card using the device's built-in SD/MMC expansion slot.

If you have access to your computer, use ActiveSync to synchronize files between your device and your computer. See "Synchronizing information with your computer" on page 31 for more information.

In instances where you are unable to access your computer, you can back up files to a storage card.

To back up individual files in a storage card:

- 1 Insert a storage card into the SD/MMC expansion slot on the top of your device. See "Using the SD/MMC expansion slot" on page 12 for more information.
- 2 Tap  > **Programs**  > **File Explorer** .
- 3 Select the file you want to back up.

11 User Support

Protecting your MC35

- 4 Tap **Menu > Edit > Copy**.

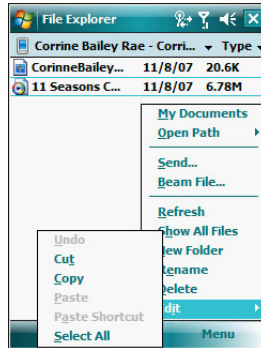

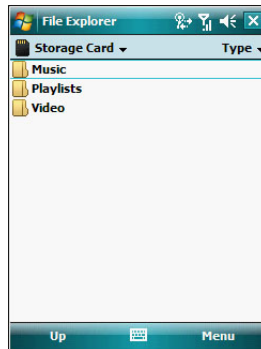

- 5 Tap the **My Device** icon (tap the folder list, labeled My Documents by default, and then My Device to see a list of all folders on your device), then select **Storage Card**.



- 6 Tap **Menu > Edit > Paste**.
- 7 After the backup process, remove the storage card from the SD/MMC expansion slot.

To back up several files in a storage card:

- 1 Insert a storage card into the SD/MMC expansion slot on the top of your device. See "Using the SD/MMC expansion slot" on page 12 for more information.
- 2 Tap  > **Programs**  > **File Explorer** .
- 3 Perform one of the following:
 - Locate the file folder containing the files you want to back up.
 - Create a new folder and move/copy the files you want to back up there.
- 4 Tap and hold the file folder you want to backup, then select **Copy** from the pop-up menu.
- 5 Tap the **My Device** icon (tap the folder list, labeled My Documents by default, and then My Device to see a list of all folders on your device), then select **Storage Card**.
- 6 Tap and hold a blank area, then select **Paste** from the pop-up menu.
- 7 After the backup process, remove the storage card from the SD/MMC expansion slot.

Troubleshooting

Troubleshooting reminders

When a troubleshooting procedure requires uninstalling the battery pack or resetting the device, note the following:

- If the procedure requires uninstalling the battery pack, first turn the device off. Once it is off, wait for five seconds to allow the device to completely enter sleep mode before removing the battery pack.

Troubleshooting procedures

The following sections describe a list of possible situations that may arise during the use of your device. Easy answers and solutions are provided for each one.

Battery problem

Battery loses power

When the battery is low, you see a battery icon  (See "Status icons" on page 18 for more information) in the navigation bar and a pop up screen that tells you to recharge the battery as soon as possible.

Your device uses a detachable and rechargeable main battery pack and an embedded battery cell. When the main battery pack is removed or is completely drained out, your device shuts down. The battery cell retains the system clock for three to five minutes while changing the main battery.

Tips on how to make battery charge last longer

To make your battery charge to last as long as possible, observe the guidelines listed below:

- Use external power whenever possible
Use the AC adapter to plug your device into external power whenever possible, especially when:
 - Establishing a remote connection
 - Using the backlight
 - Watching/listening to audio or video files
 - Connecting to a computer and/or server
- Shorten auto suspend time

While on battery power, your device automatically suspends operation if you haven't touched the hardware buttons or used the stylus for a specified period of time. Maximize battery life by shortening this time.

(a) Tap  > **Settings** .



(b) On the **System** tab, tap **Power** .

(c) On the **Advanced** tab, adjust the setting on the "On battery power" pick list.

If the device lapses into sleep mode, allow ample time before turning it back on to allow for a smoother power mode transition. The device wakes up from sleep mode when any of the following events occur:

- The Power button .
 - The device is connected to the USB sync cable.
 - A storage card is inserted into the SD/MMC expansion slot.
 - A call is received by your device.
 - A preset alarm event is activated.
- Turns off sounds you don't need.

Your device emits sounds in response to a number of events, such as warnings, reminders, and screen taps or hardware button actions. Optimize battery life, by turning off any sounds you don't need.

- (a) Tap  > **Settings** .
 - (b) On the Personal tab, tap **Sounds & Notifications** .
 - (c) Clear the check boxes on both Sound and Notifications tabs.
- Disable the phone function when no SIM card is installed on your device.

Password problem



Forgotten password

If you forget your password, you'll need to clear your device's memory by hard resetting it. See "To perform a hard reset" on page 251 for more information.

Memory problem

Memory on your MC35 EDA is shared between storage memory and program memory. Storage memory is used to store the information you create and programs you install. Program memory is used to run programs on your device. Your device automatically manages the allocation between storage and program memory.



To view memory allocation and availability:

- 1 Tap  > **Settings** .
- 2 On the System tab, tap **Memory** .



Device memory run out



If you receive a message stating that storage or program memory is unavailable, try the following solutions.

Finding space in storage memory



- Move data to an SD/MMC/SIO storage card.
 - (a) Insert a storage card to your device's expansion slot.
 - (b) Tap  > **Programs**  > **File Explorer** .
 - (c) Tap and hold the file you want to move, then tap **Cut** from the pop-up menu.
 - (d) Open the My Documents folder; tap **Menu, Edit**, then **Paste**.

NOTE: Files stored in folders other than My Documents or stored in folders within subfolders in My Documents may not show up in the list view of some programs.

- Move e-mail attachments.
 - (a) Insert a storage card to your device's expansion slot.
 - (b) Tap  > **Messaging** .
 - (c) On the Messaging tab, select the tap **Menu > Options**.
 - (d) On the Storage tab, select "When available, use this storage card to store attachments" check box.

All attachments are moved to the storage card, and new attachments are automatically stored on the storage card.
 - (e) Tap **ok**.
- Set programs such as Notes, Word Mobile, and Excel Mobile to automatically save new items on the storage card. In the program, tap **Menu > Options**.
- Delete unnecessary files.
 - (a) Tap  > **Programs**  > **File Explorer** .
 - (b) Locate the file for deletion.
 - (c) Tap and hold the file, then tap **Delete** on the pop up menu.

Finding space in program memory

- Stop programs you are not currently using.
In most cases, programs automatically stop to free needed memory. However, in some situations, such as when confirmation dialog boxes are waiting for a user response, the program may not be able to automatically stop. To check the state of your active programs:
 - (a) Tap  > **Settings** .
 - (b) On the **System** tab, tap **Memory**.
 - (c) On the **Running Programs** tab, tap the program you want to view, then tap **Activate**.
 - (d) Close any open windows or messages and return the program to list view.
If this doesn't work, you can stop the program manually.
 - (a) Close all open confirmation dialog boxes and return the program to list view.
 - (b) Stop the program by tapping **Stop** or **Stop All** on the **Running Programs** tab.
- Clear storage memory as described in the preceding section.
This frees some storage memory so that it can be allocated to program memory.
- Perform a soft reset on your device. See "To perform a soft reset" on page 251 for more information.

Screen problems

Screen freezes or responds slowly

Perform a soft reset on your device. See "To perform a soft reset" on page 251 for more information.

Screen is blank

Press and hold the Power button  for a full second. If that doesn't work:

- Remove the battery pack and check if the SIM card holder is closed properly.
- If you are using the device on battery power, shift the device to AC power.
- Perform a soft reset on your device. See "To perform a soft reset" on page 251 for more information.

Screen is dark and hard to see

The screen backlight has automatically turned off. Activate the backlight by tapping the screen or by pressing the Backlight/0 key.

If that doesn't work, the device's LCD screen may have deteriorated. Prolonged exposure to direct sunlight may have damaged the screen. Contact the Zebra Support for technical assistance. See "Customer support" on page 241 for more information.

Screen is hard to read

If you're having a hard time viewing a document in:

- Notes - try changing the size of the view. To do this, tap a zoom percentage on the **Menu**.
- Word Mobile and Excel Mobile - try changing the size of the view. Tap **View > Zoom**, then select a zoom percentage.
- Internet Explorer - try changing the font size. Tap **Menu > View > Text Size**, then select a size.

Screen flashes on then off when power button is pressed

This occurs when the screen backlight has automatically turned off but the device is still powered on.

- Tap the screen or press a key to light the display.
- Set the backlight off time to greater than or equal to the power off time.

Tapping and writing problems

Inaccurate response to stylus taps

Recalibrate the screen. See "Recalibrating the screen" on page 250 for more information.

Slow or no response

Perform a soft reset on your device. See "To perform a soft reset" on page 251 for more information.

IR connection problem

Failure to beam information

If you're having difficulty transferring information via IR, try the following:

- Transfer only one file or no more than 25 contact cards at a time.
- Align your device's IR port  with that of the receiving device so that they are unobstructed and within a close range.
- Adjust the room lighting. Some types of light interfere with IR connections. Try moving to a different location or turning off some lights.

Bluetooth connection problem

Failure to beam information

If you're having difficulty transferring information via Bluetooth, try the following:

- Transfer only one file or no more than 25 contact cards at a time.
- Turn on Bluetooth for MC35 and the receiving device.
- Make sure the devices are within close range.

Phone connection problem

If you have a problem using the phone function, try the following:

- Check if your device's wireless connection to your mobile service provider is switched on and the signal unobstructed.
- Contact your mobile phone service provider for assistance.

Internet connection problem

If you're having difficulty establishing Internet connection, try the following:

- Make sure you have properly set up a connection to your device ISP (Internet Service Provider).
- Check if your device's wireless connection to your mobile service provider is switched on and the signal unobstructed.

NOTE: When your device is connected to the USB sync cable while the GPRS function is on, you will not be able to browse web pages.

- Verify your user name and password with your device ISP.
- Verify with your device's ISP that the network you are trying to connect is available, or try to connect to it using another device or from a computer.

Network connection problem

If you're having network connection problems, try the following:

- Check if your device's wireless connection to your mobile service provider is switched on and the signal unobstructed.
- Verify that you have added necessary server information.

(a) Tap  > **Settings** .

(b) On the **Connections** tab, tap **Connections** .

Most networks use DHCP, so you need not change these settings unless your network administrator instructs you to do so.

- If the option Network Connection is not listed as a connection method in the ActiveSync dialog box when starting synchronization, wait for a few minutes and try again. Also, if synchronization does not start right away, the network is probably busy, and it may take a minute for your device to connect to the network.
- Verify your user name and password with your network administrator.
- Verify with your network administrator that the network you are trying to connect is available, or try to connect to it using another device or from a computer.
- You may need to change your device name if you are trying to connect to a network and cannot because another Pocket PC Phone with the same name is already connected. To change your device's name:

(a) Tap  > **Settings** .

(b) On the **System** tab, tap **About** .

(c) On the **Device ID** tab, enter a new name on the Device name field.

(d) Tap **ok**.

Additional troubleshooting information is available in **Connections Help** of your device and on the **ActiveSync Help** on your computer.

USB cable problem

The following solutions may help if you encounter problems when connecting to your computer.

- Make sure that your device is turned on.
- Plug the other end of the cable securely into the universal connector on the base of your device.

Additional troubleshooting information is available in **Connections Help** of your device and on the **ActiveSync Help** on your computer.

Recalibrating the screen

When you first startup your MC35, you are asked to calibrate the screen by tapping the center of a cross with your stylus as it moves around the screen. This process ensures that when you tap the screen with your stylus the item tapped is activated.

If, however, while using your device, you discover tapping an item does not bring up the appropriate response, it means the touch screen has lost its calibration.

To recalibrate the screen:

- 1 Open the **Align Screen** via software or hardware function.

- Software launching

(a) Tap  > **Settings** .

(b) On the **System** tab, tap **Screen** .

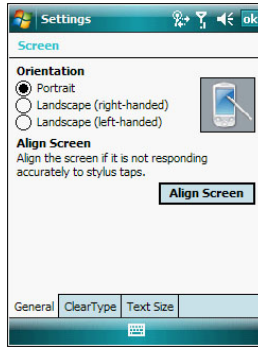

(c) On the **General** tab, tap **Align Screen**.

- Hardware launching

Simultaneously press the **Power** button  and the joystick.

- 2 Tap the center of the cross with your stylus as it moves around the screen.

Resetting your MC35

You may have to perform a reset if the device freezes (i.e., device no longer responds to the buttons on the screen).

To perform a soft reset:

A soft reset allows your device to get a fresh start, similar to rebooting a computer. This restarts your device and adjusts memory allocation. All records and entries are retained after a soft reset. Unsaved data in open programs may in some cases be lost.

- 1 Remove the stylus from its holder.

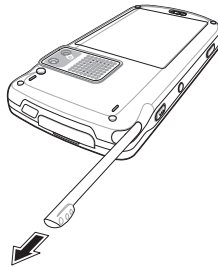

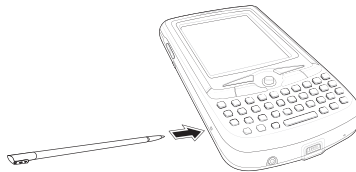

- 2 Lightly press the tip of the stylus to the reset button located on the lower-left side of the device.



To perform a hard reset:

A hard reset removes power to your device. This erases all records and entries, deletes all additional programs you have installed, and restores the device's default factory settings. Never perform a hard reset unless a soft reset does not correct your problem. When you perform your next ActiveSync operation, you can restore any data that you previously synchronized to your computer or you can restore data that you backed up to a storage card.



NOTE: When you perform a hard reset, the date and time settings are not retained. Formats, preferences, and other settings are restored to their default factory settings.

- 1 Hold down the **Power**  and **Push to Talk** buttons.
- 2 While holding down the **Power** and **Push to Talk** buttons, gently press the tip of the stylus to the **Reset** button.
- 3 Release the **Reset** button.
The message "To clear all data in the memory, press Volume Up Button. To cancel the operation, press Volume Down Button." appears.
- 4 Release the **Power**  and **Push to Talk** buttons.
- 5 Press the top key of the **Volume** button.
You will be prompted to confirm the hard reset.

Checking the OS version of your device

The MC35 operating system and software programs are stored in built-in Read Only Memory (ROM) chips. Data stored in the ROM are semi-permanent, it remains the same unless updated by a firmware updater. You may need to update the firmware of your device if new firmware patches are available. Visit <http://www.zebra.com/MC35> for software updates and hot fixes.

To check the OS version of your device:

- 1 Tap  > **Settings** .
- 2 On the System tab, tap **System Information** .

The device ROM version and application number is highlighted on the screen below.

NOTE: Zebra's MC35 OS versions are indicated by the combination of the ROM version and the Application version. For example, in the screenshot below, the MC35 OS is A00-L03S.

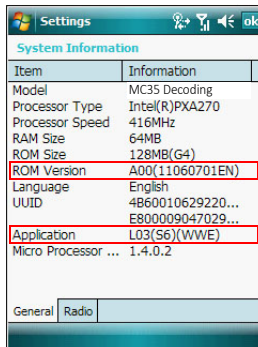

Battery pack information

CAUTION! DANGER OF EXPLOSION IF BATTERY IS INCORRECTLY REPLACED. REPLACE ONLY WITH THE SAME OR EQUIVALENT TYPE RECOMMENDED BY THE MANUFACTURER. DISPOSE OF USED BATTERIES ACCORDING TO THE MANUFACTURER'S INSTRUCTIONS.

This device is equipped with a removable and rechargeable Lithium polymer battery. When a replacement is needed, please request the dealer from whom your device was purchased to assist you. Use only manufacturer approved batteries.

Battery pack reminders

- Do not disassemble or open crush, bend or deform, puncture or shred.
- Do not modify or remanufacture, attempt to insert foreign objects into the battery, immerse or expose to water or other liquids, expose to fire, explosion or other hazard.
- Only use the battery for the system for which it is specified.
- Only use the battery with a charging system that has been qualified with the system per this standard. Use of an unqualified battery or charger may present a risk of fire, explosion, leakage, or other hazard.
- Do not short circuit a battery or allow metallic conductive objects to contact battery terminals.
- Replace the battery only with another battery that has been qualified with the system per this standard, IEEE-Std-1725-200x. Use of an unqualified battery may present a risk of fire, explosion, leakage or other hazard.
- Promptly dispose of used batteries in accordance with local regulations.
- Battery usage by children should be supervised.
- Avoid dropping the phone or battery. If the phone or battery is dropped, especially on a hard surface, and the user suspects damage, take it to a service center for inspection.
- Improper battery use may result in a fire, explosion or other hazard.

Index

A

- activate profile 135
- ActiveSync 31
 - install 3
 - requirements 3
 - synchronize Calendar 67
 - synchronize Contacts 71
 - synchronize Tasks 73, 75
 - synchronize with server 35
- add program 235
- AirBEAM 193
 - Client 193
 - configuration
 - Misc(1) tab 196
 - Misc(2) tab 197
 - Misc(3) tab 198
 - Misc(4) tab 199
 - Packages(1) tab 195
 - Packages(2) tab 195
 - Server tab 196
 - configure 194
 - package builder 193
 - synchronization with server 200

B

- back up 243
- Bluetooth
 - create partnership 48
 - send items 50

C

- Calendar 65
- call history 132
- call hold 122
- Call Me Alert
 - send 167
- call notes 123
- call notification 122
- caller identification 122
- Camera 184
 - camera screen 184
 - capture bar code data 188
 - capture mode
 - bar code 188
 - camera 184
 - record video clip 186
 - settings 189
 - take photo 185
 - view photos 188
 - view video clip 188
- CamWedge 189
 - configure 190
 - Log window 192
 - menu 189
 - Test window 191
- Certificate Import 217
- command interface 17
 - command bar 20
 - navigation bar 18

- notifications 21
- pop-up menus 20
- Today screen 17
 - command bar 20
 - navigation bar 18
 - Start menu 18
 - status icons 18

- companion programs 149, 155
 - media-related 176
 - phone management 155
 - product download-related 193
 - wireless communication 158

- conference call 123
- connections settings 232
 - Beam 232
 - Bluetooth 233
 - Connections 233
 - Express GPS Connect 233
 - Network Cards 234
 - USB to PC 234
 - WiFi 234
 - Wireless Manager 235

- connectivity features 45
 - Bluetooth 47
 - connect to e-mail server 63
 - e-mail service 63
 - infrared 46
 - WiFi 52

- Contacts 68
 - beam 71
 - call 69
 - create 68
 - find 69
 - send a message 70
 - summary screen 69
 - view 68

- contacts integration 130
- copyright iv
- customer support 241
- customize features
 - install/remove program
 - add 235
 - using ActiveSync 235
 - via Internet 236
 - remove 237, 238
- customize MC35 219

D

- device 251
 - activate from sleep mode 245
 - guides 241
 - lock 243
 - reset 251
- device features 7
 - accessories 9
 - audio 7
 - battery pack 8
 - connectivity 8
 - display 7
 - ergonomics 8
 - performance 7
- dialer screen 112
 - buttons 112
- draw on the screen 28

-
- E**
 - e-mail service 63
 - enter data 23
 - using block recognizer 25
 - using input panel 23
 - using keypad 23
 - enter PIN 111
 - Excel Mobile 83
 - create 84
 - Express GPS Connect 171
 - configure 174
 - F**
 - flight mode
 - turn off 61
 - turn on 61
 - G**
 - Gain Adjust 158
 - GPRS connection 51
 - configure 51
 - GPS Navigation 149
 - GPS navigation 149
 - H**
 - hardware interface 12
 - keypad 14
 - SD/MMC expansion slot 12
 - soft buttons 14
 - stylus 12
 - touch screen backlight key 12
 - hardware tour 10
 - I**
 - Inbox 76
 - Index 255
 - infrared
 - receive items 47
 - input panel 23
 - installing digital certificate 217
 - Internet Explorer Mobile 98
 - browse 98
 - Mobile favorites 99
 - Internet Sharing 158
 - L**
 - lock
 - keypad 242
 - screen 242
 - M**
 - manage applications 39
 - find information 42
 - open programs 39
 - organize information 43
 - MC35
 - vehicle setup 149
 - media-related program 176
 - Camera 184
 - CamWedge 189
 - Pictures & Videos 176
 - Microsoft Pocket Outlook 65
 - Calendar 65
 - open 65
 - schedule appointment 66
 - Contacts 68
 - Inbox 76
 - Notes 74
 - create note 74
 - open 74
 - Tasks 72
 - MSP Agent 210
 - main menu 211
 - My Text 30
 - N**
 - Notes 74
 - P**
 - package contents 1
 - personal settings 219
 - Buttons 220
 - Input 220
 - Lock 220
 - Menus 221
 - Owner Information 221
 - Phone 222
 - Sounds & Notifications 223
 - Today 223
 - phone 109
 - adjust volume 116
 - answer a call 116
 - end a call 116
 - erase number input 115
 - mute a call 117
 - reject a call 116
 - setup 109
 - speakerphone 116
 - status icons 113
 - turn off 115
 - turn on 114
 - phone calls 117
 - International call 121
 - using Bluetooth-enabled headset 120
 - using Call History 119
 - using dialer 117
 - using Microsoft Contacts 118
 - using SIM Manager 120
 - using Speed Dial 118
 - phone features 121
 - phone function 109
 - phone management
 - Gain Adjust 158
 - SIM Manager 155
 - SIM Toolkit 157
 - phone preferences 137
 - network 145
 - phone tab 138
 - services 140
 - call barring 140
 - call forwarding 142
 - call waiting 143
 - caller ID 141
 - fixed dialing 144
 - voice mail and text messages 144
 - Pictures & Videos 176
 - copying files 176
 - customize 182
 - full screen mode 178
 - management tasks 178
 - slide show mode 181
 - thumbnail mode 177
 - PowerPoint Mobile 85
-

- open a slide show 85
- slide show playback options 87
- product download-related program 193
 - AirBEAM Smart 193
 - Certificate Import 217
 - MSP Agent 210
 - Rapid Deployment Client 201

PTT

- turn off 169
- PTT Call History
 - view 167
- PTT calls 166
 - make call 166
 - receive call 167
- PTT Contacts 166
 - add group 164
 - add individual 163
 - delete group 165
 - delete individual 164
 - leave group 165
 - rename 164
 - rename group 165
 - status icons 166
- PTT service
 - initialize 161
- PTT Settings
 - auto accept invites 168
 - change presence status 168
- Push to Talk 161

R

- Rapid Deployment Client
 - bar code scanning 201
 - main menu 206
 - On-Demand Staging 203
 - ActiveSync mode 203
 - existing IP connection mode 204
 - WLAN connection mode 204
 - performing On-Demand Staging 204
- RD Client Version 201
- record message 29
- Remote Desktop Mobile 169
 - connecting 169
- remove program 237

S

- screen 250
 - calibrate 250
- SD driver
 - setting 238
- setup 2
 - charge 2
 - LED status 3
- setup procedures 1
 - charge your device 2
 - install battery pack 2
 - turn on 4
 - uninstall battery pack 2
- sharing contacts 130
 - call history 131
 - Microsoft Contacts 130
 - SIM Contacts 131
- SIM card
 - install 109

- SIM Manager 155
 - load 155
- SIM Toolkit 157
- speakerphone 116
- storage card
 - insert 12
 - remove 13
- synchronize with PC
 - using Bluetooth 33
 - using USB 32
- system settings 224
 - About 224
 - Brightness 224
 - Certificates 225
 - Clock & Alarms 225
 - Customer Feedback 225
 - Encryption 226
 - Error reporting 226
 - GPS 226
 - Memory 227
 - Phone Profiles 227
 - Power 228
 - Regional Settings 228
 - Remove Programs 229
 - Screen 229
 - SDSwitch 230
 - SIM Manager 230
 - System Information 231
 - Windows Update 231

T

- Tasks 72
 - beam 73
 - create 72
 - summary screen 73
- text messaging 125
- troubleshooting 245
 - battery loses power 245
 - battery problem 245
 - cable problem 249
 - connection problem
 - Bluetooth 248
 - Internet 248
 - IR 248
 - network 249
 - phone connection 248
 - memory problem 246
 - password problem 246
 - reminders 245
 - screen problems 247
 - writing problems 248

U

- unlock
 - keypad 242
 - screen 242

V

- voice mail 129

W

- Windows Live 101
 - Live Hotmail 103
 - Live Messenger 105
 - Live Sync 107
 - Sign in 102
- Windows Media Player 88
 - customize 94

file playback 92
library 89
playback controls 94
playlist 89
wireless communication program 158
Express GPS Connect 171

Internet Sharing 158
Push to Talk 161
Remote Desktop Mobile 169
Word Mobile 80
create 81
file list 81, 83



Zebra Technologies Corporation
Lincolnshire, IL U.S.A.
<http://www.zebra.com>

Zebra and the stylized Zebra head are trademarks of ZIH Corp., registered in many jurisdictions worldwide. All other trademarks are the property of their respective owners.

©2015 ZIH Corp and/or its affiliates. All rights reserved.