

OMNII HAND-HELD COMPUTER

(Windows Embedded Hand-Held 6.5)

USER GUIDE

OMNII HAND-HELD COMPUTER USER GUIDE

8000225-002

Rev. A

December 2020

This user manual supports Model Numbers:

- 7545MBW
- 7545MBWM
- 7545MBWP
- FCC ID: GM37545MBW, GM37545MBWM and GM37545MBWP
- IC: 2739D-7545MBW and 2739D-7545MBWP

Copyright

No part of this publication may be reproduced or used in any form, or by any electrical or mechanical means, without permission in writing from Zebra. This includes electronic or mechanical means, such as photocopying, recording, or information storage and retrieval systems. The material in this manual is subject to change without notice.

The software is provided strictly on an “as is” basis. All software, including firmware, furnished to the user is on a licensed basis. Zebra grants to the user a non-transferable and non-exclusive license to use each software or firmware program delivered hereunder (licensed program). Except as noted below, such license may not be assigned, sublicensed, or otherwise transferred by the user without prior written consent of Zebra. No right to copy a licensed program in whole or in part is granted, except as permitted under copyright law. The user shall not modify, merge, or incorporate any form or portion of a licensed program with other program material, create a derivative work from a licensed program, or use a licensed program in a network without written permission from Zebra. The user agrees to maintain Zebra’s copyright notice on the licensed programs delivered hereunder, and to include the same on any authorized copies it makes, in whole or in part. The user agrees not to decompile, disassemble, decode, or reverse engineer any licensed program delivered to the user or any portion thereof.

Zebra reserves the right to make changes to any software or product to improve reliability, function, or design.

Zebra does not assume any product liability arising out of, or in connection with, the application or use of any product, circuit, or application described herein.

No license is granted, either expressly or by implication, estoppel, or otherwise under any Zebra, Inc., intellectual property rights. An implied license only exists for equipment, circuits, and subsystems contained in Zebra products.

Disclaimer

Every effort has been made to make this material complete, accurate, and up-to-date. In addition, changes are periodically incorporated into new editions of the publication.

Zebra reserves the right to make improvements and/or changes in the product(s) and/or the program(s) described in this document without notice, and shall not be responsible for any damages including, but not limited to, consequential damages, caused by reliance on the material presented.

Zebra, the Zebra logo, Workabout Pro4 and the names of other products and services provided by Zebra are trademarks of Zebra.

Windows® and the Windows Logo are trademarks or registered trademarks of Microsoft Corporation in the United States and/or other countries.



The Bluetooth® word mark and logos are owned by Bluetooth SIG, Inc. and any use of such marks by Zebra is under license.

All trademarks used herein are the property of their respective owners.

Revision History

Changes to the original guide are listed below:

Change	Date	Description
Rev -001a	04/2015	Rebrand for Zebra.
Rev. -002	12/2020	Update Bluetooth terminology.

TABLE OF CONTENTS

About This Manual	xix
Text Conventions	xx
Overview of the Omnii Hand-Held Computer.....	xx
Regulatory Labels.....	xxiii

Chapter 1: Basic Operation

Omnii Features	1-3
Omnii Modules Available.....	1-5
Preparing the Omnii for Operation.....	1-5
Switching the Omnii On and Off.....	1-6
Resetting the Omnii	1-7
Performing a Warm Reset.....	1-7
Performing a Cold Reset.....	1-7
Performing a Clean Start.....	1-7
Boot to BooSt	1-8
Performing a Hard Reset	1-8
Attaching Carrying Accessories	1-8
Calibrating the Touchscreen	1-8
Imager and Scanner Options	1-9
Connectivity	1-9
Data Transfer	1-9
Phone Communication.....	1-9

Chapter 2: Getting To Know Your Omnii

Operating System	2-5
Battery Details.....	2-5
Battery Safety	2-5
Battery Swap Time	2-5
Charging the Battery	2-6
The Keyboard	2-6
The Power Button (55-Key and 66-Key Keyboards only).....	2-7

Standard Keys	2-7
Modifier Keys	2-8
Activating Modifier Keys	2-9
Locking Modifier Keys	2-9
Function Keys and Macro Keys	2-10
Function Keys	2-10
Macro Keys	2-11
Numeric Keyboards — Accessing Alpha Keys	2-11
The Keypad Backlight	2-12
The Display	2-12
Adjusting the Display Backlight	2-12
Calibrating the Touchscreen	2-13
Screen Orientation	2-13
Locking the Touchscreen	2-13
Indicators	2-14
LEDs	2-14
Battery Charge Status LED	2-15
Operating System Status LED	2-15
Radio Status LED	2-15
Scanner Status LED	2-15
Audio Indicators	2-16
Vibrations	2-16
Inserting the microSD Card and SIM Card	2-16
Inserting the Cards	2-16
Scanners and Imagers	2-17
Basic Scanner Operations	2-18
Scanning Techniques	2-18
Scanner Status LED, Sounds, and Vibrations	2-18
Troubleshooting	2-19
Operating One Dimensional (1D) Internal Laser Scanners	2-19
Operating Internal Two Dimensional (2D) Imagers	2-19
Navigating in Windows Embedded Hand-Held 6.5 and Applications	2-20
Navigating Using a Touchscreen	2-20
Navigating Using the Keyboard	2-20
The Today Screen	2-21
Customizing the Today Screen	2-22
The Today Screen Default Options	2-22
Pictures	2-22
Music	2-22
Phone	2-22
Voicemail	2-22
Time, Date and Alarms	2-23
Text Messages	2-24
E-mail Notification	2-26
Calendar of Upcoming Appointments	2-26
Creating and Editing Appointments	2-27
Deleting Appointments	2-29

Favorites	2-29
Using the Navigation Bar and Hotkeys	2-29
The Softkey Bar	2-31
The Start Button	2-31
Managing Files and Folders.....	2-31
Creating a New Folder	2-32
Renaming a File	2-32
Copying a File.....	2-32
Deleting a File.....	2-33
Using Menus	2-33
Pop-Up Menus	2-33
Programs – Using Applications	2-34
Settings	2-35
Kiosk	2-36
Data Transfer Between Omnii and a PC	2-36
Uploading Data in a Docking Station	2-36
Using Microsoft ActiveSync	2-36
Using Windows Mobile Device Center	2-37
General Maintenance.....	2-37
Caring for the Touchscreen	2-37
Cleaning the Omnii.....	2-37

Chapter 3: Programs

Programs	3-3
Home	3-3
The Phone	3-4
The Onscreen Phone Keypad.....	3-4
Sending & Ending Phone Calls Using the Onscreen Phone Keypad.....	3-4
Sending & Ending Calls Using the Omnii Keyboard	3-5
Making a Conference Call.....	3-5
Programming Speed Dial.....	3-5
Managing Phone Settings	3-8
Text Messages	3-8
E-mail	3-9
Folders.....	3-9
Synchronizing E-mail with Outlook (PC with Windows XP OS)	3-9
Changing Synchronization Settings	3-10
Synchronizing E-mail with Outlook (PC with Windows Vista or Windows 7)	3-11
Sending an E-mail	3-12
Contacts.....	3-12
Working with the Contacts List.....	3-13
Communicate Tab - Adding Contacts.....	3-14
Info Tab	3-15
Notes Tab	3-15
Internet Explorer	3-15
Browsing Web Sites	3-15
Calendar	3-16

Alarms.....	3-16
Pictures & Videos	3-17
Using the Camera.....	3-17
Moving Photos to the Omni	3-18
Opening a Photo.....	3-18
Deleting a Photo	3-18
Editing a Photo	3-19
Creating a Slide Show	3-19
Using the Video Recorder	3-19
Windows Media	3-20
Messenger (Windows Live)	3-20
Windows Live.....	3-21
Notes	3-21
Creating a Note Using the Soft Keyboard.....	3-21
Creating and Converting Handwritten Notes to Text.....	3-22
Renaming a Note.....	3-23
Recording Notes.....	3-23
Task Notification.....	3-24
File Explorer.....	3-26
ActiveSync®	3-27
Synchronization.....	3-27
Internet Sharing	3-27
Creating an Internet Connection	3-27
Using Internet Sharing.....	3-28
Task Manager	3-29
Search Phone	3-29
Imager and Camera Demo	3-31
Office Mobile.....	3-31
Excel Mobile	3-32
OneNote Mobile.....	3-32
Word Mobile.....	3-36
Text Input Modes.....	3-36
Sharing Documents with your PC	3-36
PowerPoint Mobile.....	3-36
SharePoint Workspace Mobile	3-37
PartnerUp	3-37
Kiosk	3-37
Modem Link	3-38
Remote Desktop Mobile	3-38
Connecting to a Terminal Server	3-38
Disconnecting Without Ending a Session	3-39
Ending a Session.....	3-39
SIM Toolkit UI.....	3-39
WiFiConnect A.R.C.....	3-39

Chapter 4: Settings

Overview of Software.....	4-5
---------------------------	-----

Zebra Software Advantage.....	4-5
Microsoft Software.....	4-5
Settings.....	4-5
Clocks & Alarms.....	4-6
Lock.....	4-6
Home.....	4-7
Appearance Tab – Changing the Theme (Background).....	4-7
Beaming a Theme to Another Device.....	4-7
Items Tab – Customizing the Today Screen.....	4-8
Power.....	4-9
Battery Power.....	4-9
Advanced Tab.....	4-9
Battery Details Tab.....	4-10
Suspend Threshold and Estimated Battery Backup.....	4-10
Battery Health.....	4-11
Sound & Notifications.....	4-12
Sounds Tab.....	4-12
Notifications Tab.....	4-13
Connections Folder.....	4-13
Beam.....	4-14
Bluetooth Setup.....	4-14
The Devices Tab - Scanning for Bluetooth Devices.....	4-15
Pairing a Device.....	4-17
Servers Tab.....	4-18
Mode Tab.....	4-19
About Tab.....	4-20
Paired Tab.....	4-20
Connecting Using a Bluetooth GPRS Phone.....	4-21
Connections – Connecting to the Internet.....	4-23
Modem Connection Setup.....	4-24
Advanced Modem Settings.....	4-25
Domain Enroll.....	4-26
Network Cards.....	4-27
Changing Network Card Settings.....	4-28
VPN Connection Setup.....	4-29
Managing an Existing Connection.....	4-30
Proxy Server Tab.....	4-31
Selecting a Network.....	4-32
Wi-Fi Config - Setting Up the 802.11a/b/g/n Radio.....	4-33
Wi-Fi Config: Status Tab.....	4-34
Wi-Fi Config: Configure Tab.....	4-34
Configuring TCP/IP.....	4-39
Wi-Fi Config: Advanced Tab.....	4-41
Wireless Manager.....	4-42
Personal Folder.....	4-43
App Launch Keys.....	4-43
Buttons.....	4-45

Program Buttons Tab	4-45
Up/Down Control Tab	4-46
OneShots	4-46
Macro Keys	4-47
Unicode Mapping	4-48
Scancode Remapping	4-49
Lock Sequence Tab	4-51
The Phone – Managing Settings	4-51
Phone: Sounds Tab	4-53
Phone: Security Tab	4-53
Phone: Services Tab	4-55
Phone: Network Tab	4-55
Phone: Data Tab	4-56
Phone: Bands Tab	4-56
Phone: Diagnostics Tab	4-56
Phone: Hearing Aid Mode Tab	4-57
System Folder	4-57
About	4-58
Backlight – Screen and Keypad	4-58
Battery Power Tab	4-59
External Power Tab	4-59
Backlight Tab	4-60
Certificates	4-60
Choosing a Certificate	4-60
Compass	4-62
Contrast	4-63
Customer Feedback	4-63
Dr. Debug	4-63
Status	4-64
Utilities	4-64
Motion Meter	4-65
Settings	4-65
Encryption	4-65
Error Reporting	4-66
GPS (Global Positioning System)	4-66
GPS (Global Positioning System) Settings	4-68
Imagers Settings	4-71
Manage Triggers	4-72
Trigger Mappings	4-72
Managed Programs	4-74
Memory	4-74
Main Tab	4-75
Storage Card	4-75
Microphone	4-75
PartnerUp	4-76
Quick Defrost (Heater Settings)	4-76
Kiosk	4-76

Kiosk Menu	4-77
Administrator Password	4-78
Shell Settings	4-78
Restrictions	4-83
Control Panel Settings	4-84
Import and Export Settings.....	4-85
Activating a Change – User Mode	4-87
Regional Settings	4-87
Remove Programs	4-88
Scanner Settings	4-89
Restoring Default Settings	4-89
Options Tab	4-89
Translations Tab	4-92
Port Replicator Port A (COM5) and Port B (COM6)	4-93
Screen	4-95
Screen Rotation.....	4-96
System Properties	4-97
Task Manager	4-97
Total Recall	4-98
Creating a Backup.....	4-99
Creating a Clone	4-100
Managing Profiles	4-101
Deleting a Profile.....	4-103
TweakIT	4-103
Advanced Interface and Network Settings.....	4-104
Advanced Services Settings	4-105
Registry Editor.....	4-106

Chapter 5: Accessories

Pistol Grips.....	5-3
Removing the Trigger Cover	5-3
Attaching the Pistol Grip	5-3
Carrying and Protective Accessories	5-4
The Hand Strap - Model ST6025	5-5
Protective Carrying Case - Model ST6090	5-5
Hard Shell Holster - Model ST6055	5-5
Power Accessories.....	5-6
Snap Modules	5-6
AC Wall Adaptor - Models ST1050 and ST1050-AR	5-8
Vehicle Power Outlet Adaptor - Model ST3113.....	5-8
Chargers and Docking Stations: General Information	5-9
Important Charger Safety Instructions	5-9
Charging the Battery	5-9
Installation — Chargers and Docking Stations	5-10
Operator Controls	5-10
Power Consumption Considerations.....	5-10

Desktop Docking Stations - Models ST4002 and ST4003.....	5-10
Charging a Battery Installed in Omni.....	5-12
Indicators	5-13
Operation	5-13
Charging the Omni Battery.....	5-13
Charging the Spare Battery	5-13
Cleaning the Desktop Docking Station.....	5-13
Troubleshooting	5-14
Docking station does not seem to power on.	5-14
Omni charge indicator LED stays off.....	5-14
Omni charge indicator LED is red.	5-14
Spare battery LED is red with a battery installed.	5-14
Spare battery LED does not turn on when a battery is installed.	5-14
Quad Docking Station – Model No. ST4004.....	5-15
Operator Controls	5-15
Indicators	5-16
Quad Docking Station Operation	5-16
Charging the Omni Battery.....	5-16
Installation.....	5-16
Connecting to the Ethernet Network	5-17
Cleaning the ST4004.....	5-17
Troubleshooting	5-18
Omni Charge Indicator LED Stays Off	5-18
Power LED Does Not Light Up	5-18
Omni Charge LED Flashes Yellow	5-18
Omni Charge Indicator LED is Red.....	5-18
Powered Adaptor LED Stays Off.....	5-18
Vehicle Cradles - Models ST1000 and ST1002	5-18
Vehicle Cradle Mounting Recommendations.....	5-19
Insertion and Removal of Omni.....	5-21
Maintaining the Vehicle Cradle.....	5-22
ST1002 Powered Cradle Installation.....	5-22
Wiring Guidelines.....	5-23
Installation in High Voltage Vehicles	5-23
Wiring Vehicle Power and Communications to the Cradle.....	5-24
Battery Charger (6-Slot) - Model ST3006.....	5-26
Installation.....	5-26
Operator Controls	5-27
Charge Indicators	5-27
Charging Batteries.....	5-27
Troubleshooting	5-28
Improper Battery Storage.....	5-28
Power Self-test LEDs Don't Light Up	5-28
Indicator Does Not Light When Battery Installed	5-28

Appendices

Appendix A: Port Pinouts

Omnii Docking Connector	A-3
Snap Modules Connectors.....	A-4
Cable Connectors for Vehicle Cradle Model ST1002	A-5
Omnii Battery Contacts	A-6

Appendix B: Imagers Applet

The Imagers Applet.....	B-3
Required Applets.....	B-3
Presets	B-3
Predefined Presets	B-3
Barcode Predefined Presets	B-3
Barcode Decoding Symbology Predefined Presets	B-4
Barcode Decoding Camera Predefined Presets	B-4
Image Capture Predefined Presets.....	B-5
Using the Imagers Applet.....	B-5
Configuring the Image Capture Presets.....	B-5
Selecting a Camera	B-6
Setting the Active Preset.....	B-6
Viewing a Preset	B-6
Creating a Custom Preset.....	B-6
Modifying a Custom Preset.....	B-7
Removing a Custom Preset	B-8
Configuring the Barcode Decoding Camera Presets	B-8
Selecting a Camera	B-9
Setting the Active Preset.....	B-9
Viewing a Preset	B-9
Creating a Custom Preset.....	B-10
Modifying a Custom Preset.....	B-11
Removing a Custom Preset	B-12
Configuring the Barcode Decoding Symbologies	B-12
Setting the Active Preset.....	B-12
Viewing a Preset	B-12
Creating a Custom Preset.....	B-13
Modifying a Custom Preset.....	B-14
Removing a Custom Preset	B-15
Filter Tab – Manipulating Barcode Data	B-15
Modifying a Barcode Setting	B-15
Translation Tab – Configuring Rules	B-16
Case Rules.....	B-17
Advanced Tab	B-18
File Locations for Captured Images	B-18
Configuring Triggers.....	B-18
Barcode Symbologies	B-19
Imager Barcode Symbologies	B-20
Color Camera Barcode Symbologies.....	B-21

Appendix C: Scanner Settings

Barcode Settings	C-3
Scanner Options	C-3
Restoring Default Settings	C-4
Decoded (Internal) Scanners	C-4
Options	C-4
Decoded (Internal) Advanced Options	C-5
Decoded (Internal) Data Options	C-6
Decoded (HHP)	C-7
Decoded (Intermec ISCP)	C-7
Decoded (ISCP) Options	C-7
Decoded (ISCP) Advanced Options	C-7
Non-Decoded Scanners	C-9
Options	C-9

Appendix D: Internal Imager & Scanner Specifications

Internal Scanners and Imagers	D-3
SE955 Scanner	D-3
SE955 Decode Zones	D-3
SE965 Scanner	D-4
SE965 Decode Zones	D-5
SE1224HP - High Performance Scanner	D-6
SE1224HP Decode Zones	D-6
SE1524ER – Extended Range Scanner	D-7
SE1524ER Decode Zones	D-7
EV15 Imager	D-8
EV15 Imager Decode Zone	D-8
EA11 Decoded 2D Imager	D-9
EA11 Typical Reading Distances	D-10
EA20X Imager	D-10
EA20X Typical Reading Distances	D-11
HHP 5080SR Imager/Decoder	D-12
HHP 5080SR Working Range	D-12
SE4500SR – Standard Range Imager	D-13
SE4500SR Decode Zone	D-15
SE4600LR – Long Range Imager	D-16
SE4600LR Decode Zones	D-18

Appendix E: Omni Specifications

The Omni Hand-Held Computer (Model 7545)	E-3
Hardware	E-3
Regulatory Approvals	E-5
Lithium-ion Smart Battery 5000 mAh (ST3001)	E-5
Wireless Radios	E-6
Cinterion, Model MC75i GSM/GPRS/EDGE Radio	E-6
Cinterion PH8-P GSM/GPRS/EDGE/UMTS/HSPA+ Radio	E-7
802.11a/b/g/n Radio	E-9
Bluetooth Radio	E-11

Chapter F: Omni XT15f Freezer Variants

The Omni XT15f Hand-Held Computer (Model 7545XT).....	F-3
Hardware Specifications.....	F-4
Regulatory Approvals	F-5
The Freezer Keyboards.....	F-6
Lithium-ion Smart Battery 5000 mAh (ST3001) for Omni Chiller Model	F-6
Lithium-ion Smart Battery 5300 mAh (ST3002) for Omni Arctic Model.....	F-7
Quick Defrost Application.....	F-8
Settings.....	F-9
Suspend Threshold.....	F-9
Scan Window	F-9
Heater Info.....	F-9
Heater System	F-10
Display and Scan Window Heaters.....	F-11
System Test.....	F-11
System Properties.....	F-12

Appendix G: Wireless Wide Area Network (WWAN)

Wireless WAN.....	G-3
Navigation Bar Icons.....	G-3
Establishing a Packet Data Connection.....	G-3
Disconnecting from a Network	G-5
Advanced Packet Data Configuration	G-5
Manually Adding a New Modem Connection	G-5
The Security Tab – Entering a PIN.....	G-7
Bands.....	G-7
Network Configuration	G-8
Hearing Aid	G-8

Appendix H: Omni XT15ni Non-Incendive Safety Guidelines

Omni XT15ni (non-incendive) Important Safety & Regulatory Information	H-3
Omni XT15ni Battery Information.....	H-4

Index.....	I
-------------------	----------

ABOUT THIS GUIDE

About This Manual	xix
Text Conventions	xx
Overview of the Omnii Hand-Held Computer	xx
Regulatory Labels	xxiii

About This Manual

This user manual describes how to configure, operate, and maintain the Omnii Hand-Held Computer.

Chapter : About This Guide

provides a basic overview of the Omnii Hand-Held.

Chapter 1: Basic Operation

describes the steps required to get the Omnii ready for operation.

Chapter 2: Getting To Know Your Omnii

describes Omnii features, including how to charge and maintain the battery, the keyboard features, the display, using the internal scanner, etc. This chapter also describes how to navigate the Microsoft® Windows® Embedded Hand-Held 6.5 Today screen, how to transfer data between the Omnii and a PC and how to manage files and folders.

Chapter 3: Programs

provides a description of the Microsoft® Windows® Embedded Hand-Held 6.5 Programs applets and how to use them.

Chapter 4: Settings

provides details about Microsoft® Windows® Embedded Hand-Held Settings applets and how to use them.

Chapter 5: Accessories

describes the peripherals and accessories available for your Omnii computer.

Appendix A: Port Pinouts

describes pinouts for the Omnii docking connector, snap module connectors, battery contacts, and vehicle cradle cable connectors.

Appendix B: Imagers Applet

describes in detail the Omnii imager settings.

Appendix C: Scanner Settings

describes the barcode options.

Appendix D: Internal Imager & Scanner Specifications

lists the specifications for the Omnii scanners and imagers.

Appendix E: Omnii Specifications

lists the specifications for your Omnii computer, radios, and battery.

Appendix F: Omnii XT15f Freezer Variants

provides specifications for the Omnii XT15f freezer variants and the Arctic freezer battery (ST3002). In addition, the “Quick Defrost” applet is described here.

Appendix G: Wireless Wide Area Network (WWAN)

provides WWAN configuration information.

Appendix H: Omnii XT15ni Non-Incendive Safety Guidelines

lists the approvals, important warnings, and cautions for the Omnii XT15ni (non-incendive) Hand-Held Computer.

Text Conventions



NOTE Notes highlight additional helpful information.



IMPORTANT These statements provide particularly important instructions or additional information that is critical to the operation of the equipment.



WARNING These statements provide critical information that may prevent physical injury, equipment damage or data loss.

Overview of the Omnii Hand-Held Computer

The Omnii Hand-Held Computer is a modular, industrial hand-held computer. A variety of options are available to suit applications in courier/delivery, field service, manufacturing facilities, material handling applications in warehouses, ports and yards, with a focus on real time wireless data transactions. Barcode input methodologies are supported by a variety of available scanners. Optimization for specific operational environments is also supported with a wide range of peripheral options and carrying accessories.

The Omnii XT15f (Freezer Variant) combines modularity, customizability and performance with added technology to resist condensation for use in cold, condensing environments. For details, see [Appendix F: “Omnii XT15f Freezer Variants”](#).



NOTE The Omnii Hand-Held Computer is a body worn device, and to maintain compliance with the FCC RF exposure guidelines, use a Zebra approved carrying case. Use of non-approved accessories may violate FCC RF exposure guidelines.



NOTE For product specifications, refer to [Appendix E: “Omnii Specifications”](#).

Model Variants

- Omnii RT15 Hand-Held Computer (rugged) – Model 7545XC
- Omnii XT15 Hand-Held Computer (extremely rugged) – Model 7545XA
- Omnii XT15f (Freezer Variants) Hand-Held Computer (extremely rugged) - Model 7545XT

Processor and Memory

- Texas Instruments® AM3715 Sitara (OMAP3® compatible), ARM Processor 800 MHz.
- RAM: 512 MB.
- Flash ROM: 1 GB.

Operating System

- Microsoft Windows® Embedded Hand-Held 6.5

Bundled Applications

- Internet Explorer® Mobile
- Windows® Office Mobile 2010, includes Word, Excel, PowerPoint, OneNote & SharePoint
- Windows Office Outlook Mobile
- Windows Media Player Mobile

Supported Applications

- Open TekTerm.
- Stay-Linked Terminal Emulation.
- Naurtech Browser.
- Naurtech Terminal Emulation.
- NetMotion Mobility XE VPN.

Device Management and Utilities

- Kiosk.
- Mobile Control Centre (MCC).
- Total Recall, TweakIt, Dr. Debug.

User Interface

- Colour/Touch Display 9.4 cm (3.7 in) diagonal
 - VGA (640 x 480) Transflective.
 - High visibility option: superior sunlight visibility with 165 cd/m2 brightness.
 - Extreme Duty option: withstands 1.25 Joule impact, superior low temperature operation (to -20° C/-4° F), with 160 cd/m2 brightness. Better abrasion resistance.
- Touchscreen
 - Passive stylus or finger operation; pan and flick gestures supported.
 - Signature capture.
- Keyboards
 - Large selection of backlit keypads in both alpha and numeric formats. For a list of currently available keyboard configurations, consult your Zebra representative, or go to: http://www.Zebra.com/US-EN/Product+Lines/Psion/?WT.mc_id=psion_us_p_handheld
- Voice, Audio & Feedback
 - High volume beeper: 95 dBA.
 - Integrated microphone and speaker.
 - Optional Push-to-Talk Speaker.
 - Vibration feedback.
 - Walkie-talkie style Push-to-Talk – VoIP over Wi-Fi or WWAN.

Wireless Connectivity

- Integrated Bluetooth® V2.0 + EDR.
- Onboard IEEE 802.11a/b/g/n Wi-Fi (CCX V4 Pending) radio.
- Bluetooth® coexistence.
- Optional SIRF III GPS Receiver.
- Optional 2.5 G GSM/GPRS/EDGE radio.
- Optional UMTS 3.8 G HSPA+ radio



NOTE 802.11a/b/g/n and Bluetooth are available simultaneously.

The following figures illustrate the main features of the Omnii — for detailed views, please see “Omnii Features” on page 1-3.

Figure 1 Omnii XT15 and Omnii RT15 Variants



Figure 2 Bottom View (Docking Connector)



Figure 3 Top View (Scanner Window)



Figure 4 Omnii XT15f Freezer Variant



NOTE For details about the Omnii XT15f freezer units, refer to [Appendix F: “Omnii XT15f Freezer Variants”](#)



Regulatory Labels



WARNING Using controls or adjustments or performing procedures other than those specified herein may result in hazardous radiation exposure.

Figure 5 *Laser Warning Label*

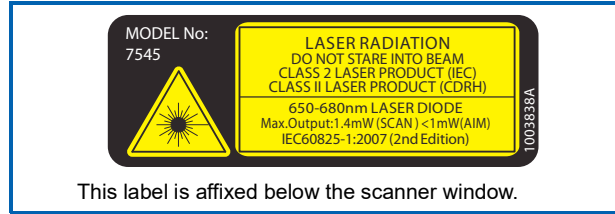

Figure 6 *SE955 Laser Warning Label*

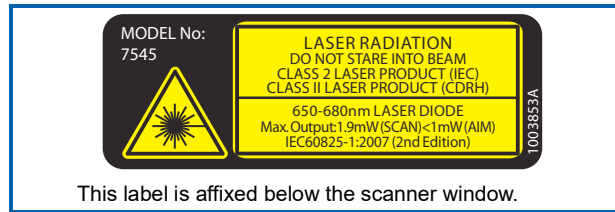

Figure 7 *SE965 and SE4500 Laser Warning Label*



Figure 8 *LED Radiation Notice Label*

This label is affixed below the scanner window.

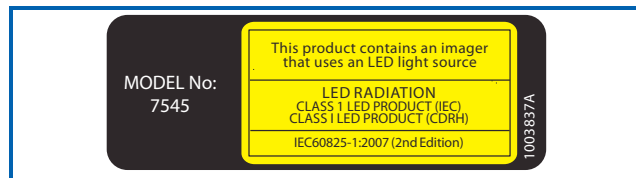

Figure 9 *SE4600 Laser Warning Label*

This label is affixed below the scanner window.



CHAPTER 1 BASIC OPERATION

Omnii Features	1-3
Omnii Modules Available	1-5
Documents Available	1-5
Preparing the Omnii for Operation	1-5
The Battery	1-5
Switching the Omnii On and Off	1-6
Resetting the Omnii	1-7
Performing a Warm Reset.	1-7
Performing a Cold Reset	1-7
Performing a Clean Start	1-7
Boot to BooSt	1-8
Performing a Hard Reset	1-8
Attaching Carrying Accessories	1-8
Calibrating the Touchscreen	1-8
Imager and Scanner Options	1-9
Connectivity	1-9
Data Transfer	1-9
Phone Communication	1-9

Omnii Features

Figure 1-1 Front View of the Omnii XT15 Model with Alphanumeric Keyboard



Figure 1-2 Side Views of the Omnii XT15



Figure 1-3 Bottom View

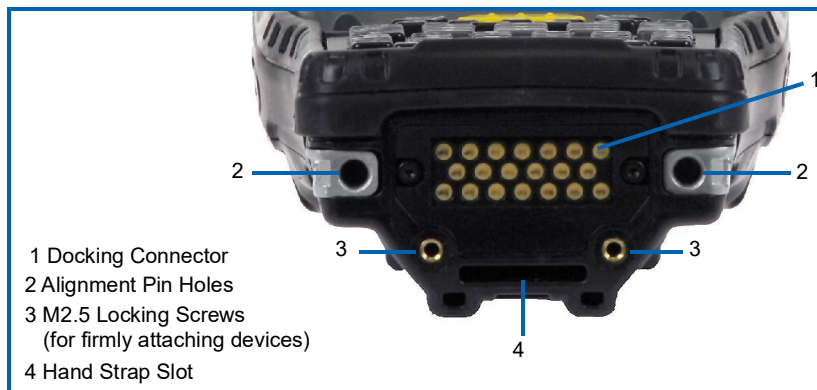

Figure 1-4 Top View



Figure 1-5 Back View



Omnii Modules Available

To see a current list of Omnii accessories and modules, go to the Zebra website at:
http://www.zebra.com/US-EN/Product+Lines/Psion/?WT.mc_id=psion_us_p_handheld

Documents Available

To see a current list of documents and download what you need, go to the Knowledge Base on the Zebra Ingenuity Working community website:

<http://www.ingenuityworking.com/knowledge/w/knowledgebase/product-manuals.aspx>

Preparing the Omnii for Operation

The Battery

The Omnii is powered by a Lithium-ion Smart Battery pack, 5000 mAh — Model ST3001.



IMPORTANT

Before charging the battery, it is critical that you review the battery safety guidelines in the Omnii Hand-Held Computer Regulatory & Warranty Guide (PN 8000191).

Battery packs shipped from the factory are charged to approximately 40% and must be fully charged prior to use. Batteries can be charged using a variety of chargers and docking stations. For detailed information, see [“Battery Details” on page 2-5](#).

Replacing the Battery Pack



IMPORTANT

Always switch the unit off before changing the battery (see [“Switching the Omnii On and Off” on page 1-6](#)). However, assuming the default power saving parameters and battery reserve level have not been altered, battery swap time is a minimum of 4 minutes — you will not lose data if the battery is replaced within this time frame.

Figure 1-6 *Omnii Battery*

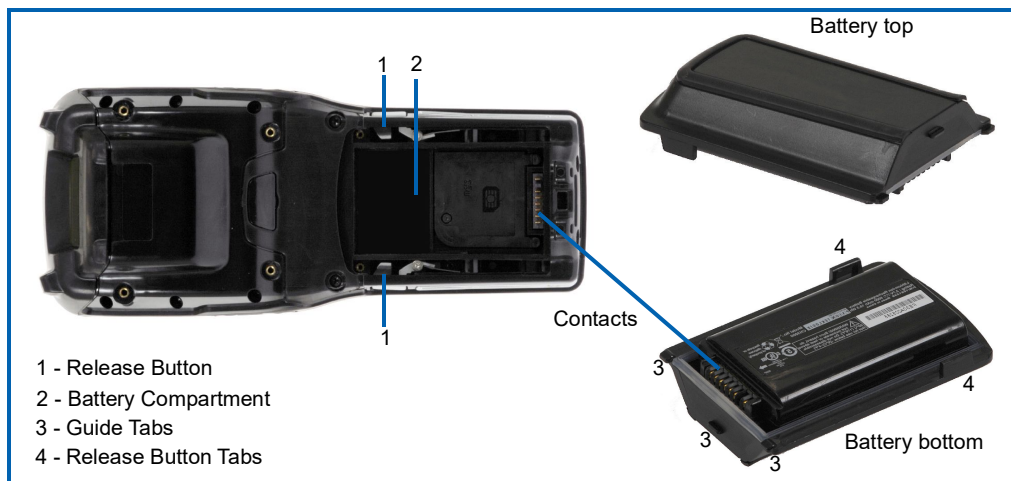

NOTE If you are using a docking station or an external power supply, you can insert an uncharged battery and use the device while the battery charges.

Assuming the default power saving parameters and battery reserve level have not been altered, a battery can be removed for up to 4 minutes without losing data. After 4 minutes the hand-held may reboot.

Removing the Battery Pack

- If your unit is equipped with a hand strap, unhook it from the base of the battery.
- Press the two latch buttons at the sides of the compartment simultaneously, and slide the battery out.

Installing the Battery Pack

- Slide the charged battery with the contoured plastic facing you into the unit with the contacts matching position and the guide tabs moving into the corresponding slots at the base of the compartment. Firmly click both sides of the battery into place.
- If your computer is equipped with a hand strap, re-attach the clip to the slot at the base of the battery.
- Switch the unit on (see [“Switching the Omnii On and Off” on page 1-6](#)).

Switching the Omnii On and Off

Follow the instructions below for your Omnii.

Switching the Omnii On

- Press and hold the **[Power]** button down for at least one second.

When the unit is turned off, normally it automatically enters a power-saving, “suspend” state. When the Omnii is switched on from the suspend state, operation resumes within a few seconds in the screen in which you were working prior to turning the computer off.

**IMPORTANT**

If your Omnii fails to power up, consider the following troubleshooting options:

The battery may be overheated (>60C°), a non-Zebra battery may be installed, or the battery may have fallen below the configured Suspend Threshold. See “[Suspend Threshold and Estimated Battery Backup](#)” on [page 4-10](#) for details.

To switch on the hand-held, you will need to replace the overheated battery.

However, if you supply AC power to the Omnii with a battery that falls below the configured Suspend Threshold, the unit will switch on.

Switching the Omnii Off

- To switch off the Omnii, press the **[Power]** button. The Omnii will automatically enter the Suspend state.

**IMPORTANT**

Turning off the hand-held does not result in a complete shutdown; rather, the unit enters a power-saving, “suspend” state. When the Omnii is turned on from suspend state, operation resumes within a few seconds.

Resetting the Omnii

To perform a variety of Omnii resets, you can use the keyboard shortcuts described below.

Performing a Warm Reset

During a warm reset, running programs are halted. The contents of the file system, Flash Disk, and the registry are preserved. Keep in mind, however, that RAM content is not preserved.

- Press and hold down the **[FN]** key and the **[Power]** button simultaneously for a minimum of four seconds.



NOTE For radio specifications, switching from Windows Zero Config to WiFi Config (DeviceScape) and visa versa requires a warm reset.

Performing a Cold Reset

A cold reset reinitializes all hardware. All RAM including the RAM disk is erased. Non-volatile storage such as the Flash disk is preserved, as is the file system.

To execute a cold reset:

- Press and hold down the **[SYM]** key, the **[FN]** key, and the **[Power]** button, simultaneously for a minimum of four seconds.

Performing a Clean Start

A clean start returns the Omnii to factory settings, flushes the registry keys and deletes volatile storage.

- Press and hold down the **[FN]** key, the **[Power]** button and the **[SCAN]** key simultaneously for a minimum of six seconds.

The Omnii displays the Boot to BooSt menu.

- On an alpha keyboard, type **.clean**.
- On a numeric keyboard, type **.25326**.

Boot to BooSt

If you choose Boot to BooSt, the BooSt menu is loaded.

- Press and hold down the **[FN]** key, **[Power]** button and **[SCAN]** key for a minimum of four seconds.
- Press **[1]** to launch the OS.

Performing a Hard Reset



IMPORTANT This procedure is recommended as a last resort, when all other methods fail.

To execute a hard reset:

- Remove the battery.
- Using a coin, or other conductive item, connect pins 5 and 6 of the Omnii battery contacts for at least six seconds.



- Replace the battery and power the Omnii on. The computer will boot as if from a cold reset.

Attaching Carrying Accessories

Zebra recommends that a carrying accessory — a hand strap — be installed on the Omnii before use. For detailed information, see [“Carrying and Protective Accessories” on page 5-4](#).

Calibrating the Touchscreen

The Omnii touchscreen feature is factory-calibrated and ready-to-go; however, over time the touchscreen's operating parameters may change, and it may need to be recalibrated for correct operation. Refer to [“Calibrating the Touchscreen” on page 2-13](#) for details.

Imager and Scanner Options

If your Omnii is equipped with an internal imager or scanner, review the relevant sections: [Appendix B: “Imagers Applet”](#) and [Appendix C: “Scanner Settings”](#) for details.

[Appendix D: “Internal Imager & Scanner Specifications”](#) lists their current model numbers, descriptions, and specifications.

Connectivity

For information on connecting the Omnii to a PC, refer to [“Data Transfer Between Omnii and a PC” on page 2-36](#).

The Omnii contains an integrated 802.11a/b/g/n radio module. The Wi-Fi Config application is used to configure the radio for one or more wireless network profiles. To configure the radio, follow the steps outlined under the heading [“Wi-Fi Config - Setting Up the 802.11a/b/g/n Radio” on page 4-33](#).

The Omnii is also available with one of the following Wireless WAN radio options: the Cinterion MC75i EDGE or the Cinterion PH8-P HSPA+. Refer to [“Wireless Radios” on page E-6 in Appendix E: “Omnii Specifications”](#) for full specifications. With either of these radios and a SIM card, you can wirelessly transfer data (see [Appendix G: “Wireless Wide Area Network \(WWAN\)”](#)), and you can use the Omnii voice option to place phone calls (refer to [“The Phone” on page 3-4](#) and [“The Phone – Managing Settings” on page 4-51](#)).

To configure your Bluetooth settings, go to [“Bluetooth Setup” on page 4-14](#).

If you have a GPS (Global Positioning System) module, you can choose from a set of GPS profiles built into the modem and set up AGPS (Assisted Global Positioning System). See [“GPS \(Global Positioning System\)” on page 4-66](#).

Data Transfer

Data transfer options vary slightly depending on the type of operating system installed in your PC. Various options exist depending on whether you are using Windows XP or earlier, Windows Vista[®] or Windows 7. For connection details, refer to [“Data Transfer Between Omnii and a PC” on page 2-36](#).

Phone Communication

If the Cinterion MC75i EDGE WWAN or Cinterion PH8-P HSPA+ radio modem is installed and enabled, the Phone icon and the GSM signal strength icon will appear when you tap on the navigation bar at the top of the screen. The 55-key and 66-key keyboards are also equipped with [Talk] and [End] phone keys. For details about using the phone options, refer to [“The Phone” on page 3-4](#) and [“The Phone – Managing Settings” on page 4-51](#).



NOTE The voice option is not available in North America for the Cinterion MC75i EDGE radio.

CHAPTER 2 GETTING TO KNOW YOUR OMNII

Operating System	2-5
Battery Details	2-5
Battery Safety	2-5
Battery Swap Time.	2-5
Charging the Battery.	2-6
The Keyboard	2-6
The Power Button (55-Key and 66-Key Keyboards only).	2-7
Standard Keys	2-7
Modifier Keys.	2-8
Activating Modifier Keys	2-9
Locking Modifier Keys	2-9
Function Keys and Macro Keys.	2-10
Function Keys	2-10
Macro Keys	2-11
Numeric Keyboards — Accessing Alpha Keys	2-11
The Keypad Backlight	2-12
The Display	2-12
Adjusting the Display Backlight	2-12
Calibrating the Touchscreen	2-13
Screen Orientation	2-13
Locking the Touchscreen	2-13
Indicators.	2-14
LEDs	2-14
Battery Charge Status LED	2-15
Operating System Status LED	2-15
Radio Status LED	2-15
Scanner Status LED	2-15
Audio Indicators	2-16
Vibrations.	2-16
Inserting the microSD Card and SIM Card	2-16

Inserting the Cards	2-16
Scanners and Imagers.	2-17
Basic Scanner Operations	2-18
Scanning Techniques.	2-18
Scanner Status LED, Sounds, and Vibrations	2-18
Troubleshooting.	2-19
Operating One Dimensional (1D) Internal Laser Scanners	2-19
Operating Internal Two Dimensional (2D) Imagers	2-19
Navigating in Windows Embedded Hand-Held 6.5 and Applications.	2-20
Navigating Using a Touchscreen	2-20
Navigating Using the Keyboard	2-20
The Today Screen	2-21
Customizing the Today Screen	2-22
The Today Screen Default Options	2-22
Pictures	2-22
Music.	2-22
Phone	2-22
Voicemail	2-22
Time, Date and Alarms	2-23
Text Messages	2-24
E-mail Notification	2-26
Calendar of Upcoming Appointments	2-26
Creating and Editing Appointments	2-27
Deleting Appointments	2-29
Favorites	2-29
Using the Navigation Bar and Hotkeys	2-29
The Softkey Bar	2-31
The Start Button	2-31
Managing Files and Folders.	2-31
Creating a New Folder	2-32
Renaming a File	2-32
Copying a File	2-32
Deleting a File	2-33
Using Menus	2-33
Pop-Up Menus	2-33
Programs – Using Applications	2-34
Settings	2-35
Kiosk	2-36
Data Transfer Between Omnii and a PC	2-36
Uploading Data in a Docking Station	2-36
Using Microsoft ActiveSync	2-36
Using Windows Mobile Device Center	2-37
General Maintenance	2-37
Caring for the Touchscreen	2-37

Cleaning the Omnia2-37

Operating System

- Microsoft® Windows® Embedded Hand-Held 6.5

Battery Details

Omnii Hand-Held Computers operate by lithium-ion battery packs, Model ST3001.

Review the following sections for detailed battery information:

- Installation: [“Preparing the Omnii for Operation” on page 1-5.](#)
- Power settings: [“Power” on page 4-9.](#)
- Chargers and docking stations: [Chapter 5: “Accessories”.](#)
- Specifications: [“Lithium-ion Smart Battery 5000 mAh \(ST3001\)” on page E-5.](#)
- Contact pinout: [“Omnii Battery Contacts” on page A-6.](#)

Battery Safety



IMPORTANT

Before attempting to install, use, or charge the battery pack, it is critical that you review and follow the important safety guidelines in the quick reference guide entitled Omnii Hand-Held Computer Regulatory & Warranty Guide, PN 8000191.

Battery Swap Time

Assuming the default power saving parameters and battery reserve level have not been altered, battery swap time is a minimum of 4 minutes — you will not lose data if the battery is replaced within this time frame.

To protect data, the safest place to store data is on a microSD memory card or externally on a USB memory stick or on a PC. You can also save data in the “Flash Disk” partition of the file system.

Refer to [“Suspend Threshold and Estimated Battery Backup” on page 4-10](#) for details about reserving battery power for data backup purposes.

The Suspend Threshold adjustment in the Power Properties tab allows you to determine the battery capacity at which the Omnii will be shut down. If left at the default value, Maximum Operating Time, the unit will run until the battery is completely empty; the RAM is only backed up for a short period of time. If you choose Maximum Backup Time, the Omnii shuts off with more energy left in the battery so RAM can be backed up for a longer period of time.



IMPORTANT

If your Omnii fails to power up, consider the following troubleshooting options:

The battery may be overheated (>60C°), a non-Zebra battery may be installed, or the battery may have fallen below the configured Suspend Threshold. See [“Suspend Threshold and Estimated Battery Backup” on page 4-10](#) for details.

To switch on the hand-held, you will need to replace the overheated battery.

However, if you supply AC power to the Omnii with a battery that falls below the configured Suspend Threshold, the unit will switch on.

Charging the Battery

Batteries shipped from the factory are charged to approximately 40% of capacity. Lithium-ion battery packs must be fully charged before use. These batteries can be charged with a variety of chargers and docking stations. For detailed information about these accessories, please see [Chapter 5: “Accessories”](#).

Normally it takes 3 to 4 hours to charge a battery. The Omnii intelligent charging system protects the battery from over-charging by terminating the charge process when the battery is at maximum capacity.

% Charge Completed	During Sleep Mode	While Operating
100%	4 hrs.	8 hrs.
75%	2 hrs.	6 hrs.



IMPORTANT

To avoid damaging the battery, chargers will not begin the charge process until the battery temperature is between 0°C to 45°C (32°F to 113°F).

The Keyboard

The Omnii can be ordered with a wide variety of Alpha and Numeric keyboard layouts. See:

http://www.Zebra.com/US-EN/Product+Lines/Psion/?WT.mc_id=psion_us_p_handheld

for a list of available configurations. Most of the keys on these keyboards operate much like a desktop computer. Where a key or key function is not consistent with the PC keyboard, those differences are described in the following sections.

Depending on the type of keyboard on your Omnii, the keyboard is equipped with a dedicated [Power] button or an [ENTER/Power] combination key both of which allow you to switch the unit on.

The [BLUE/FN] modifier key provides access to additional keys and system functions. These functions are colour coded in blue print above the keyboard keys.



NOTE Almost all keys can be reprogrammed to suit your requirements.

Figure 2-1 Keyboard Layouts

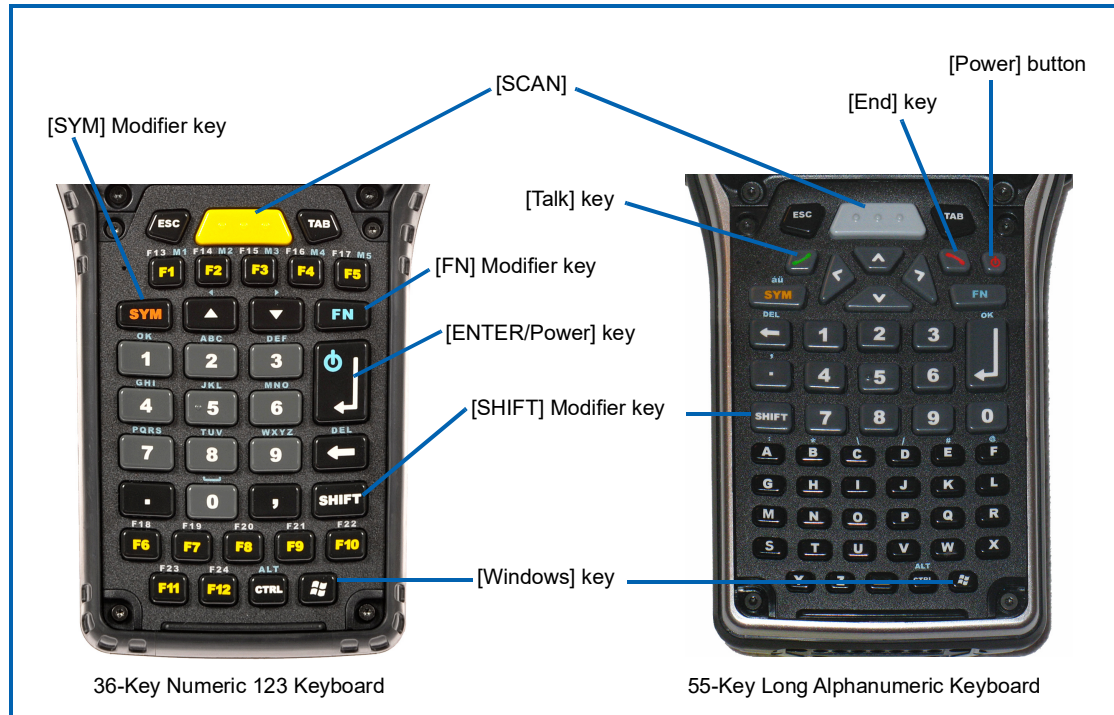

The Power Button (55-Key and 66-Key Keyboards only)

The [Power] button in the upper right corner of the keyboard switches the unit on and off.

Standard Keys

The [ENTER/Power] Key

The [ENTER/Power] key is used to execute the usual Enter keyboard functions as well as to power the unit on and off for keyboards not equipped with a dedicated [Power] button (for details, refer to “[Switching the Omnii On and Off](#)” on page 1-6).



NOTE 55-key and 66-key keyboards are equipped with a [Power] button. For these keyboards, the [ENTER] key does not switch on the unit.

The [SHIFT] Key

The [SHIFT] key is used to display uppercase alpha characters and to provide access to other symbols and functions on the numeric keyboards. Press the [SHIFT] key to turn the shift state 'on' (it will be represented in the shift-state indicator in the navigation bar at the top of the screen), then press another key to access the shifted function of that key.

Press the [SHIFT] key twice to lock the shift state on (the shift-state will be outlined in a black frame to indicate it is locked 'on'). Press [SHIFT] again to turn the shift state off.

To access CAPS LOCK mode, press [FN] + [SHIFT]. In this state, if you press a numeric key, the number is displayed rather than the normal shifted function of that key. Press [FN] + [SHIFT] again to turn the CAPS LOCK mode off.

The Arrow Keys

The [Arrow] keys are located near the top of the keyboard, and are represented on the keyboard as triangles pointing in different directions. The [Arrow] keys move the cursor around the screen in the direction of the arrow: up, down, left and right. The left arrow key should not be confused with the [BACKSPACE] key which is depicted as a left arrow. The cursor is the flashing box or underline character that indicates where the next character you type will appear.

The [BACKSPACE/DEL] Key

The [BACKSPACE] key (represented on the keyboard as an arrow pointing left) moves the cursor one character to the left, erasing the previous key stroke.

The [DEL] key ([FN] +[BACKSPACE]) erases the character at the current cursor position.

The [CTRL] and [ALT] Key

The [CTRL] and [ALT] keys modify the function of the next key pressed and are application dependent. Pressing either key twice locks it 'on'. Pressing the key once again unlocks it.

The [TAB] Key

Typically, the [TAB] key moves the cursor to the next field to the right or downward.

The [ESC] Key

Generally, this key is used as a keyboard shortcut to close the current menu, dialog box, or activity.

The [SPACE] Key

The [SPACE] key is represented on the keyboard by a long, horizontal line bracketed by a small vertical line on each side. Pressing this key inserts a blank space between characters. In a Windows dialog box, pressing the [SPACE] key enables or disables a checkbox.

The [SCAN] Key

The Omnii is equipped with a single [SCAN] key on the keyboard and an extra [SCAN] button located on the left side of the unit. [SCAN] keys activate the scanner beam. For units that do not have internal scanners, these keys can be remapped to serve other functions.

Modifier Keys

The [SHIFT], [CTRL], [ALT], [FN] and [SYM] keys are modifier keys that change the function of the next key pressed.

The [SHIFT], [CTRL] and [ALT] keys operate much like a desktop keyboard except that they are not chorded (two keys held down simultaneously). The modifier key must be pressed first followed by the key whose function you want modified.

[SHIFT] and [FN]

The [SHIFT] and [FN] modifier keys provide access to additional keys and system functions. The functions related to these modifier keys are colour-coded in white and blue print respectively above the keyboard keys, dependant on your keyboard format.

[SYM]



NOTE When using the Mobile Devices SDK Developers' Guide (PN 8100016), note that the [SYM] key is interchangeable with the [ORANGE] key.

The Symbol [SYM] modifier key provides access to commonly used symbolic characters. Pressing the [SYM] key brings up the Symbol soft input panel (SIP) onscreen keyboard, with symbols mapped to each key.



NOTE Modifier keys are remapped using the Scancode Remapping applet. The Symbol SIP will automatically display and use the new mappings after the next reboot.

The onscreen keyboard corresponds to the specific keyboard on your Omnii — either numeric or alphanumeric. The sample below reflects an alphanumeric keyboard layout.

Figure 2-2 *Symbol Soft Input Panel*

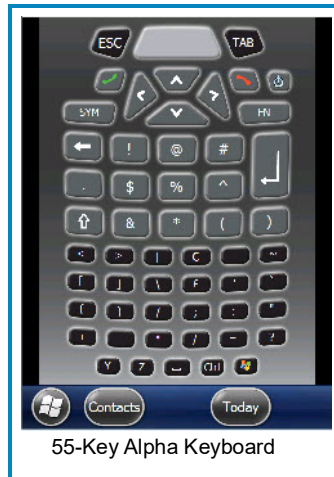

Activating Modifier Keys

When a modifier key is pressed, it is represented in the shift-state indicator icon in the navigation bar at the top of the screen, making it easier to determine whether or not a modifier key is active. For example, when the blue [FN] key is pressed, it is represented in blue in the shift-state indicator icon at the top of the screen.

Figure 2-3 *Shift-State Indicator Icon*



Locking Modifier Keys

When a modifier key is locked 'on', it will remain active until it is pressed again to unlock or turn it off.

To help you identify when a modifier key is locked 'on', the key is represented in the shift-state indicator icon with a black frame around it.

Figure 2-4 Shift-State Indicator Icon – Locked/Unlocked Modifier Key

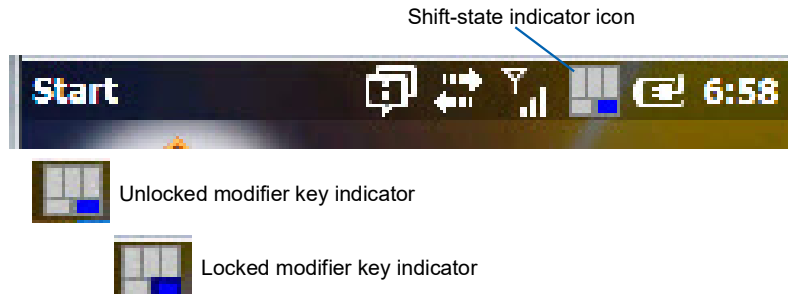

Once a modifier key is unlocked or turned off, it is no longer displayed in the shift-state indicator icon.



NOTE The locking function of the modifier keys can be changed so that pressing a modifier key **once** will lock it 'on'.

If you disable the 'One Shot' function of the key, pressing it once will lock the key 'on'. Pressing the same key a second time will unlock or turn it 'off'. Refer to "OneShots" on page 4-46 for details.

Function Keys and Macro Keys

In addition to the standard keyboard functions, the Omnii supports function keys and macro keys.

All function keys and macro keys can be custom defined for each application. The Open TekTerm application utilizes these keys (for detailed information, see the Open TekTerm Software User Manual, PN 8000073).

Function Keys

Function keys perform special, custom-defined functions within an application. These keys are accessed by pressing one of the dedicated function keys on the keyboard, or through the appropriate [SHIFT] or [FN] key sequence, depending on the keyboard variant being used.

Alphanumeric Keyboard Function Keys

The alphanumeric keyboards are equipped with up to thirty function keys, including those function keys that are colour-coded in blue print above the alpha keys or function keys (depending on your keyboard).

To access the blue function keys, press the [FN] key followed by the appropriate alpha or function key.

Function keys [F1] through [F24] can be used with the Windows Embedded Hand-Held 6.5 operating system or another application. The additional function keys, [F25] through [F30] along with the macros, are not used as part of the Windows Embedded Hand-Held 6.5 operating system.

Numeric Keyboard Function Keys

The numeric keyboards are equipped with up to 24 function keys, including those function keys that are colour-coded in white print above the function keys. Function keys F25 through F30 can only be accessed by remapping another key to that function.

To access the white function keys, press the [SHIFT] key followed by the appropriate function key.

Macro Keys



IMPORTANT

Refer to [“Macro Keys” on page 4-47](#) for details about creating macros.

Several of the Omnii keyboards are equipped with a series of macro keys that can be programmed to replace frequently used keystrokes, along with the function of executable keys like the [ENTER/Power] key, the [BACKSPACE] key, any function key and arrow key, etc.

59-Key Alphanumeric Keyboard Macro Keys

These keyboards have six macro keys: [M1] to [M6], located on the S to X keys (second-last row of keys).

To access a macro key, press the [FN] key followed by the macro key.

36-Key Numeric Keyboard Macro Keys

These keyboards are equipped with five macro keys: [M1] to [M5]. These keys are colour coded in blue print above function keys [F1] to [F5].

To access a macro key, press the [FN] key followed by the macro key. To create a macro, refer to [“Macro Keys” on page 4-47](#).

Whether your keyboard does or does not have macro keys physically stamped on the keyboard, up to 15 macro functions can be added using the Scancode Remapping function. Refer to [“Scancode Remapping” on page 4-49](#) for details about mapping keys.

Numeric Keyboards — Accessing Alpha Keys

On Numeric Omnii keyboards, all alphabetic characters are printed on the unit plastic in blue typeface above the keys. Alpha characters are accessed by pressing the [FN] modifier key, then pressing another key on the keyboard.

Alpha Modified Numeric 789 keyboards have each blue alphabetic character assigned as a single [FN]-shifted character on individual keys.

Numeric 123 keyboards have telephone-style alphabetic keys, with the blue alphabetic characters located in groups of 3 or 4 above each of the numeric keys. To access characters on these keyboards, a few extra steps are needed, as described below.

Choosing a Single Alpha Character



NOTE The following examples assume that the [FN] key is enabled as ‘Lock’ mode in the ‘One Shot’ screen (accessed by choosing Start>Settings>Personal>Buttons icon). In ‘Lock’ mode, pressing the [FN] key once locks it ‘on’. Refer to [“One-Shots” on page 4-46](#) for details.

The examples below illustrate how to access A, B and C, all of which are printed in blue characters above the numeric key [2] on a 36-Key Long Numeric 123 keyboard.



IMPORTANT

The letters you choose appear in the shift-indicator icon at the top of the screen, providing a visual indicator of which letter will be displayed on the screen.

To choose the letter ‘a’:

- Press the [FN] key, and press the numeric key [2].

- Press the **[FN]** key again to unlock or turn it off.



NOTE To choose the second, third or fourth alpha character assigned to a numeric key, you may want to lock the **[FN]** key 'on'. Remember that depending on how your Omnii is set up in the 'One Shots' tab, you may find that you need to press the **[FN]** key twice to lock it 'on'. Refer to [“OneShots” on page 4-46](#) for details.

To choose the letter 'b':

- Lock the **[FN]** key 'on', and press **[2]** twice.
- Press the **[FN]** key again to unlock or turn it off.

To choose the letter 'c':

- Lock the **[FN]** key 'on', and press **[2]** three times.
- Press the **[FN]** key again to unlock or turn it off.



NOTE Keep in mind that there is a timeout of one second between key presses when sequencing through the alphabetic characters on a key. If you pause longer than one second between key presses, the alphabetic character that is displayed at that time will be entered.

Selecting Uppercase Letters

To display a single capital letter, press the **[SHIFT]** key first, then the letter you want.

To access CAPS LOCK mode, press **[FN] + [SHIFT]**. In this state, if you press a numeric key, the number is displayed rather than the normal shifted function of that key. Press **[FN] + [SHIFT]** again to turn the CAPS LOCK mode off.

The Keypad Backlight

The intensity of the keypad backlight can be configured using the Backlight icon accessed by tapping on Start>Settings>System>Backlight. Refer to [“Backlight – Screen and Keypad” on page 4-58](#) for details about this option.



NOTE Keep in mind that this option may be restricted to supervisory use only.

The Display

The Omnii is equipped with display backlighting to improve character visibility in low light conditions. The backlight switches on when a key is pressed.

Adjusting the Display Backlight

To set the backlight intensity and the duration of time that the backlight will remain on, you'll need to choose the Backlight icon.

- Tap on **Start>Settings** and then, tap on **System>Backlight** icon.

Refer to [“Backlight – Screen and Keypad” on page 4-58](#) for details.

Calibrating the Touchscreen

If your touchscreen has never been aligned (calibrated) or if you find that the stylus pointer is not accurate when you tap on an item, follow the steps below.

- Tap on **Start>Settings>System**. Tap on the **Screen** icon.



The General tab is displayed in which you can correct alignment and choose screen orientation (see “[Screen Orientation](#)” on page 2-13 for details).

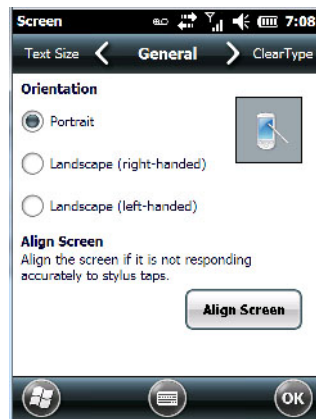

- Tap on the **Align Screen** button, and follow the directions on the screen to align (calibrate) the screen.



NOTE This window provides two additional tabs: ClearType and Text Size. Tapping on the ClearType tab allows you to enable the ClearType option to smooth screen font appearance. The Text Size tab allows you to increase or decrease the size of the font displayed on the screen.

Screen Orientation

In addition to screen calibration, the Screen icon allows you to determine how your screen will be oriented – portrait or landscape (right- or left-handed).

- Tap on **Start>Settings>System** icon.
- Tap on the **Screen** icon.
- In the **General** tab, tap on the orientation that best suits the way in which you use your Omnii.



NOTE For information about screen rotation, refer to “[Screen Rotation](#)” on page 4-96.

Locking the Touchscreen

If you need to lock your touchscreen to protect against accidental actions:

- At the Today screen, tap on the **Start** icon.
- Tap on the **Lock icon** in the softkey bar at the bottom of the screen. A sliding lock is displayed on the screen.



- Place the stylus on the sliding lock, flick it to the right and release to unlock the touchscreen and display the screen options.

Indicators

The Omnii uses LEDs (Light Emitting Diodes), onscreen messages, vibrations, and audio tones as indicators.

LEDs

The Omnii is equipped with four coloured LEDs. This section outlines what these LEDs indicate.



IMPORTANT If an LED is illuminated in red, the operator should be cautious as this generally indicates an abnormal operating condition or active laser emission.

Figure 2-5 LED Status Indicators



Battery Charge Status LED

The far left LED is reserved for battery charge status. This indicator is active even when the hand-held is inserted in a docking station (and in suspend mode) so that the charge status of the battery can be detected easily.

Charge LED Behaviour	Function
OFF	External power not detected.
Solid Green	Battery charging complete.
Flashing Green	Charge in progress.
Yellow	Cell temperature out of range for charge.
Solid Red	Unable to charge battery.

Operating System Status LED

The second LED indicates system notifications and operating system status. It is also available for user-loaded custom Windows Embedded Hand-Held 6.5 applications.

Operating LED Behaviour	Function
OFF when unit is in Suspend or Shutdown.	Normal operating status.
Solid Yellow	The unit is powering on.
Fast Flashing Yellow	The unit is entering Suspend mode.
Flashing Yellow	This is application dependent.

Radio Status LED

The third LED from the left – the blue LED – indicates that the GPS radio is enabled or that the WWAN radio is enabled.

Radio Traffic LED Behaviour	Function
OFF	The radio is disabled.
Slow Flashing Blue	The radio is enabled and active.

Scanner Status LED

The fourth (far right) LED indicates scanner status.

Scan LED Behaviour	Function
OFF	The scanner is not in use.
Solid Red during scan	Scan in progress.
Solid Green after decode	Successful scan.
OFF when scan ended	
Flashing Red	Unsuccessful scan.

Audio Indicators

The Omnii supports several audio options, including Bluetooth. The optional rear speaker can be used for system (Windows) sounds and .wav files. When a rear speaker is absent, those sounds are routed to the front receiver. The beeper provides a variety of sounds and can be configured to emit a sound to signal a number of events such as screen taps, notifications, and so on. The volume rocker button is located on the left side of the hand-held. Information on configuring sounds is detailed in [“Sound & Notifications” on page 4-12](#).

Vibrations

You can set the Omnii to vibrate when a successful or unsuccessful barcode scan is performed. See [“Good Scan Beep and Bad Scan Beep” on page 4-91](#).

Inserting the microSD Card and SIM Card

There are two slots available in the battery compartment — the lower slot is provided for a microSD (Secure Digital) card, which provides additional non-volatile memory to your Omnii, and the upper slot is for a SIM (Subscriber Identity Module) card, which allows access to the Voice option, access to the Internet, and so on.

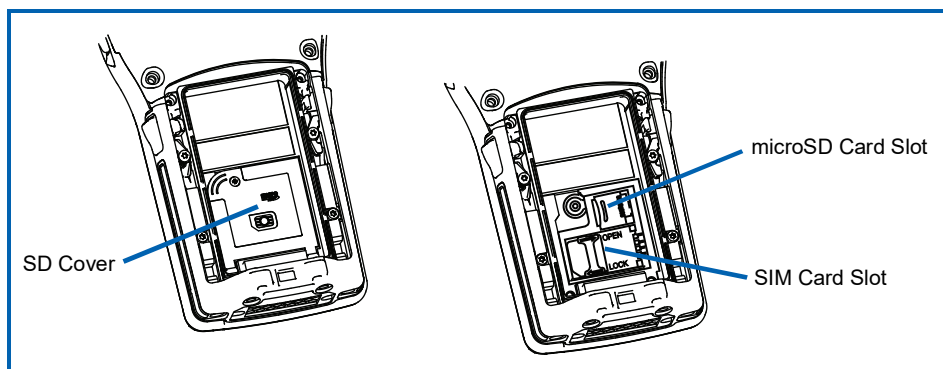

Inserting the Cards

- Switch off the power to the Omnii.
- Remove the battery.
- Use a Phillips screwdriver to remove the SD cover screw. Flip the cover open or remove it.

For a microSD card:

- Slide the microSD card door to the left to unlock it. Flip it open.
- Slide the microSD card into the guides on the SD card door.
- Close the microSD card door, and slide it to the right to lock it.

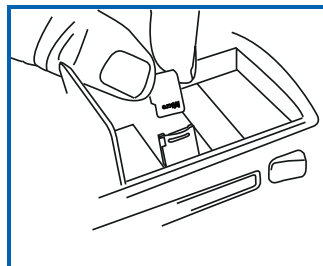

For a SIM card:

- Slide the SIM card metal door latch to the right to unlock it, then flip the door open.
- Slide the card into the guides on the SIM card door.
- Swing the hinged door back down into place, and slide the metal door latch to the left to lock it.

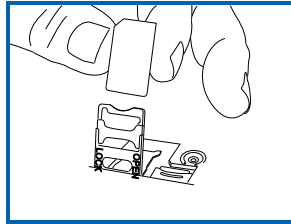

Scanners and Imagers



IMPORTANT

It is critical that you review the “Laser Warnings” in the Omnii Hand-Held Computer Regulatory & Warranty Guide (PN 8000191) before using any of the scanners described in this chapter.

For detailed scanner specifications and decode zone tables, refer to [Appendix D: “Internal Imager & Scanner Specifications”](#).



NOTE To enable a newly-installed imager or scanner, press and hold down the [FN] key and the [ENTER/Power] key simultaneously for a minimum of three seconds. If your unit has a [Power] button, press and hold down the [FN] key and the [Power] button for a minimum of three seconds.

The Omnii supports a wide range of scanner options to address a variety of user application requirements. Refer to the following sections for detailed information:

- Scanner list and specifications: [Appendix D: “Internal Imager & Scanner Specifications”](#).
- Configuration: [“Scanner Settings” on page 4-89](#) and [“Manage Triggers” on page 4-72](#).
- [“Scanning Techniques”](#) outlines the mechanics of a successful scan.
- [“Scanner Status LED, Sounds, and Vibrations”](#) details how to interpret whether or not a barcode has been successfully scanned.
- Barcode Parameters: [Appendix C: “Scanner Settings”](#).
- Imager Settings: [Appendix B: “Imagers Applet”](#).
- [“Troubleshooting”](#) provides some helpful suggestions should the scan fail.

Scanner types include:

- Long Range: reads large 1D barcodes (55 mil) at long distances (up to 3 m).
- Standard Range/High Performance: reads damaged or low contrast regular 1D barcodes (5 - 55 mil) at medium distances (up to 1m).
- Extended Range: reads regular 1D barcodes (5 - 55 mil) at short to medium distances (1 m), as well as large 1D barcodes (e.g. 55 mil) at long distances.
- 1D Imager: reads regular 1D and PDF417 barcodes at short to medium distances.

- EA11 2D imager: reads 1D and 2D barcodes including damaged and low contrast regular 1D barcodes. Smallest barcode at 5 mil with a minimum read distance to 2.8 inches and a maximum read distance of 5.1 inches; largest barcode at 40 mil with a minimum read distance of 3.1 inches and a maximum distance of 32.4 inches.
- EA20X 2D imager: reads 1D and 2D barcodes including damaged and low contrast regular 1D barcodes. Smallest barcode at 6 mil with a minimum read distance of 6.1 inches and a maximum read distance of 9.1 inches. Largest barcode at 40 mil with a minimum read distance of 5.1 inches and a maximum read distance of 49.2 inches.
- SE4600LR imager: captures digital images for transmission to a decoder to decode a barcode of any format supported by the decoding software. Uses laser aiming, LED illumination, and CMOS sensors to capture barcode images over an extended range and under a wide variety of lighting conditions.

Basic Scanner Operations

- Turn the hand-held on. Wait until the unit has booted up completely.
- Aim at the barcode and press the scan key or the trigger. A scan beam and a warning indicator appear until a successful decode is achieved or six seconds have elapsed.

Scanning Techniques

- Hold the scanner at an angle. Do not hold it perpendicular to the barcode.
- Do not hold the scanner directly over the barcode. In this position, light can reflect back into the scanner's exit window and prevent a successful decode.
- Scan the entire barcode. If you are using a 1D or PDF laser scanner, make certain that the scan beam crosses every bar and space on the barcode, including the margins on either end of the symbol.
- If you are using a 2D imaging scanner, make certain the red, oval shaped framing mark is centered within the barcode you want to scan.
- When using imaging scanners, do not move the scanner while decoding the barcode. Movement blurs the image.
- Hold the scanner farther away for larger barcodes.
- Hold the scanner closer for barcodes with bars that are close together.

Scanner Status LED, Sounds, and Vibrations

The scanner LED (the far right LED) indicates whether or not your scan is successful. The LED behaves as follows:

- Scan In Progress: scan LED displays solid red colour.
- Successful Scan: scan LED displays solid green colour and turns off when the scan is ended.
- Unsuccessful scan: scan LED flashes red.

A barcode icon appears on the screen during a scan. While the scanner beam is active, the onscreen message states: SCANNING. If you want to turn off the onscreen message, disable the Scan Indicator. (Refer to [“Scan Indicator” on page 4-90](#).)

When the scan is successful, the barcode data is displayed on the screen until the scan button (or pistol trigger) is released, but only if the Scan Result parameter is turned on. Refer to [“Scan Result” on page 4-90](#).

You can also enable sounds and vibrations to indicate good and bad scans by enabling Good Scan Beep and Bad Scan Beep and Good and Bad Scan Vibrates. Refer to [“Good Scan Beep and Bad Scan Beep” on page 4-91](#) for details.

Troubleshooting

If the scanner is not working, investigate the following:

- Is the unit on?
- Check that the barcode symbology being scanned is enabled for the hand-held you are using. Check any other parameters that affect the scanning procedure or the barcode.
- Check the barcode to make sure it is not damaged. Try scanning a different barcode to verify that the problem is not with the barcode.
- Check that the barcode is within the proper range.
- Does the hand-held display the warning without scanning? This suggests a hardware problem in the hand-held.
- Is the laser beam scanning across the barcode?
- Once the scan beam has stopped, check the scanner window for dirt or fogging.

Operating One Dimensional (1D) Internal Laser Scanners

- Turn the hand-held on. Wait until the unit has booted up completely.



IMPORTANT

If an aiming dot is available on the installed scanner, the dot will be enabled for a configurable time period (including off), after which normal scanning begins. Refer to [“Dot Time \(msec\)” on page C-4 in Appendix C: “Scanner Settings”](#) for details.

Double-clicking the trigger will override the aiming delay and initiate an immediate scan. Note that the aiming dot is standard on long-range and high visibility internal scanners.

- Aim at the barcode and press the scan key or the trigger. A scan beam and a warning indicator appear until a successful decode is achieved or six seconds have elapsed.

Operating Internal Two Dimensional (2D) Imagers

An imager scanner takes a snap shot of a single barcode or multiple barcodes (at one time). It can find a barcode regardless of its orientation — that is, even a barcode printed at a 45 degree angle to the hand-held will be decoded successfully.



NOTE When scanning **multiple** barcodes, ensure that all of the desired barcodes are within the field of view of the scanner. It is possible that even when all barcodes are within the field of view, not all of them will be decoded. Only successfully decoded barcodes are passed to the application program. The application program then issues a warning, asking that you scan the missing barcodes.

When scanning a **single** barcode, ensure that only the desired barcode is within the field of view of the scanner.

Because imager scanners generally have a shorter depth of field than laser scanners, some practise may be required to find the optimal distance from the types of barcodes being scanned. Although the imager includes illumination LEDs, ambient light will help the imager decode the barcodes, especially if the barcode is far from the hand-held.

**IMPORTANT**

Keep in mind that the imager scanner is a camera, and the LED illumination is a flash. Glare can be an issue on reflective media such as plastic coated barcodes, just as glare is an issue for photographers. When pointing at a shiny surface, either shift the barcode to the side or top, or angle the barcode so that the glare reflects away from the imager scanner.

Most imagers take several 'snap shots' of the barcode in order to decode it. It is normal for the LEDs to flash two or three times. Hold the unit steady between flashes to improve decode performance.

- Turn the hand-held computer on. Wait until the unit has booted up completely.
- Aim at the barcode and press the scan key or the trigger. Hold the trigger until a successful or failed scan result is obtained.
- When the scan button or trigger is pressed, a red, oval shaped light (the framing marker) is displayed. Centre the framing marker in the field — either in the centre of the barcode you want to scan or in the centre of the area in which multiple barcodes are to be scanned.

The illumination LEDs will flash (typically several times) and a picture of the barcode is taken.

Navigating in Windows Embedded Hand-Held 6.5 and Applications

Graphic user interfaces like Windows Embedded Hand-Held 6.5 for portable devices or desktop Windows (2000, XP, etc.) utilize 'point and click' navigation. On the Omnii, this is accomplished using a touchscreen and stylus rather than a mouse.

Navigating Using a Touchscreen



NOTE If the touchscreen is not registering your screen taps accurately, it may need recalibration. Refer to ["Calibrating the Touchscreen" on page 2-13](#).

A touchscreen is a standard feature on all Omnii hand-held computers. Each is shipped with a stylus – a pointing tool.

- Use the stylus to tap on the appropriate icon to open files and folders, launch applications and programs, make selections, and so on. You can also use your finger rather than the stylus.
- Tap and flick the stylus or your finger on the screen to scroll through the options on a screen.
- Tap on the navigation bar to display additional icons.

Navigating Using the Keyboard

If you prefer to use the keyboard to move the cursor around the screens on your Omnii, refer to the table following for a description of the navigation keys.

Operation	Key or Key Combination
Switch between active applications	[ALT] [TAB]
Open task manager	[ALT] [ESC]
Move the cursor	Arrow keys

Operation	Key or Key Combination
Open file, folder or icon	[ENTER]
Exit & Save	[ENTER]
Close/Exit & Do Not Save	[ESC]
Navigate Dialog Boxes	[TAB] To move cursor up [SHIFT] [TAB] To display the contents of the next 'tab' in a dialog box [CTRL] [TAB]
Select Radio Button/Press Button	[SPACE]
Go to Start Menu	[Windows]

Keep in mind that unlike a desktop computer, the Omnii does not support key chording (pressing two keys at the same time). You must press one key followed by the next in sequence.

The Today Screen

The Today screen provides quick access to a default list of applets such as phone, voicemail, and so on. This screen is also equipped with a navigation bar along the top of the screen which provides access to hotkeys. Hotkeys act as shortcuts to apps. Along the bottom of the screen, a softkey bar contains softkeys that help you navigate – in particular, the Start button which provides access to everything else you'll need to work with Windows Embedded Hand-Held 6.5.



- Use the stylus or your finger to scroll to and highlight the option you want to work with. The highlighted option displays information specific to the applet. For example, highlighting the Calendar option lets you know if there are any appointments.
- Tap on any highlighted option to display the associated dialog box. Note that you can also double-tap on any option to display the associated dialog box.

Depending on which option you tap on, the softkeys at the bottom of the screen change to help support working with the particular option you've chosen.

Customizing the Today Screen

The items you see in the Today screen are Windows defaults. To customize the screen to suit your purposes:

- Tap on the **Start** button. Tap on the **Settings** icon followed by the **Home** icon.
- In the scrolling tab bar at the top of the screen, scroll to the **Items** tab.

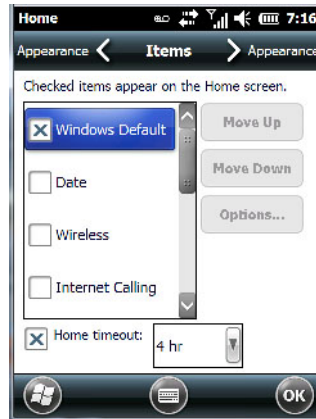

The items you select will appear in the Today screen. Once you've chosen the items to appear on the Today screen, you can also tailor the order in which you want the items to appear:

- Highlight an **item**. Tap on the **Move Up** and **Move Down** buttons to order your selections.

When you choose items for the Today screen using this method, the appearance of the Today screen will change to a list format.

The Today Screen Default Options

A list of options are available from the Today screen. Keep in mind that these can be altered using the method described above in [“Customizing the Today Screen” on page 2-22](#). You can also refer to [“Shell Settings” on page 4-78](#) for additional customization options.

Pictures

This option provides access to the Pictures & Videos applet. Refer to [“Pictures & Videos” on page 3-17](#) for details.

Music

Tapping on the Music option displays the Windows Media applet. Refer to [“Windows Media” on page 3-20](#) for details.

Phone

- Scroll to and highlight the **Phone** option to learn if you've missed any calls.
- Tap the stylus on the highlighted **Phone** option to display the phone console.

Refer to [“The Phone” on page 3-4](#) for details about using the phone.

Voicemail

Highlighting Voicemail lets you know if you have any new voice messages. Tapping the stylus on this option displays the phone console so that you can dial the phone number to access your voice messages.

If your service supports voicemail but it has not been set up:

- Tap on **Voicemail** in the Today screen.

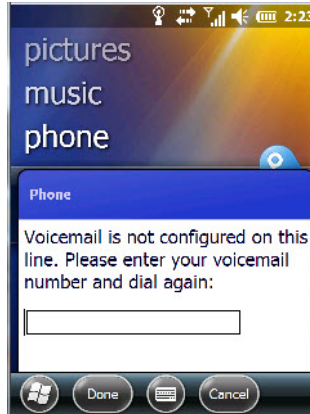

- Type your **voicemail number**.

Time, Date and Alarms

- Tap on **Start>Alarms** icon to display Clock & Alarms screen.

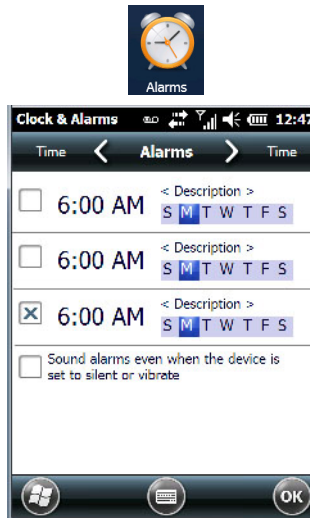

Setting the Alarm

You can set a maximum of three alarms.

- In the **Alarms** tab, tap on the **Time** or **Day** in the Clock & Alarms screen. An Alarm Settings screen is displayed.

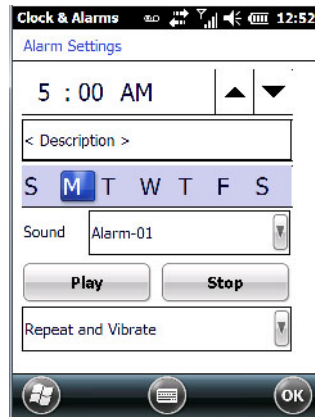

- To set the time, **highlight** the **hours** and then the **minutes** in the clock and use the arrow keys to increase or decrease the numbers, or type the hours and minutes directly from the keyboard or soft keyboard.
- Type a description in the Description field.
- Tap on the **day** on which you want the alarm to go off – **Sunday** through **Saturday**.
- Next, choose the **Sound** - you can tap on the Play button to experiment with the sounds. You can also choose No Sound.
- In the drop-down menu below the Play button, you can choose how the alarm will behave, whether or not it will repeat and so on.
- Tap on **OK** to save your changes.

Setting the Time and Date

To set the time on the Omnii:

- If it is not already displayed, tap on the **Time** tab at the top of the screen.

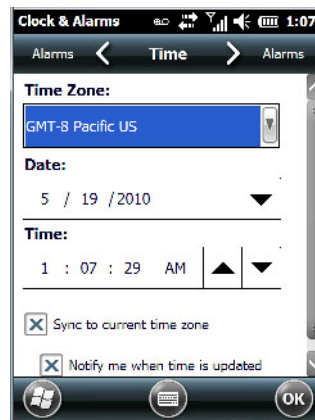

- Choose the appropriate **Time Zone**, set the **Date**, and the current **Time**.

Text Messages

In the Today screen, highlighting Text lets you know if you have any new text messages. Tapping the stylus on this option displays the Text Messages screen.



To compose and send a text message on your Omnii:

- Tap on the **Menu** softkey, and choose **New** from the menu.

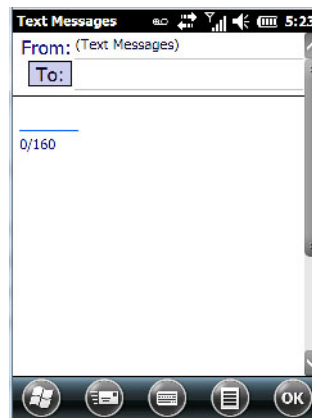

- In the To field, type the **name** of the person to whom you want to send a text message, or to insert a number from your contacts list, tap on **Menu>Add Recipient**, and choose a name.
- Tap your stylus in the message area, and type your message.
- Tap on the **Send** softkey to deliver your message.



Once you send the message, your message is displayed in the Inbox and a conversation icon is displayed in the softkey bar.

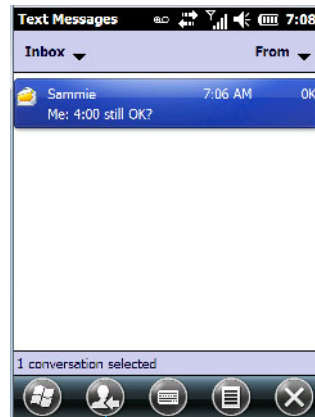

Conversation softkey

Highlighting the text message and tapping on the conversation softkey automatically connects to the sender's information so you can compose a reply.

E-mail Notification

If you have any e-mail, highlighting this option lets you know if you have any unread e-mail. To view e-mail:

- Tap on the **E-mail** option in the Today screen, or tap on **Start** followed by the **E-mail** icon to launch your e-mail.



NOTE Refer to [“Synchronizing E-mail with Outlook \(PC with Windows XP OS\)”](#) on page 3-9 and [“Synchronizing E-mail with Outlook \(PC with Windows Vista or Windows 7\)”](#) on page 3-11 for details about synchronizing your e-mail.

Calendar of Upcoming Appointments

This option is used to map out all your upcoming appointments, meetings and so on in the weeks, months and years ahead.



NOTE You can synchronize the Calendar so that any meetings, appointments and so on are displayed on your Omnii Today screen as well as on your PC. Refer to [“Synchronizing E-mail with Outlook \(PC with Windows XP OS\)”](#) on page 3-9 and [“Synchronizing E-mail with Outlook \(PC with Windows Vista or Windows 7\)”](#) on page 3-11 for details.

- In the Today screen, tap on **Calendar**, or tap on **Start>Calendar** icon to display the calendar applet.

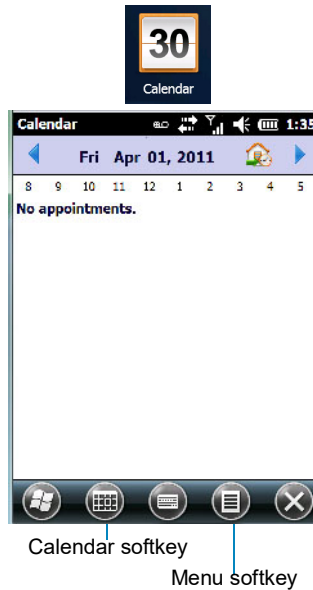

The default calendar displays any scheduled appointments. To choose the format of your calendar:

- Tap on the **Calendar** softkey – this key scrolls through the calendar formats.

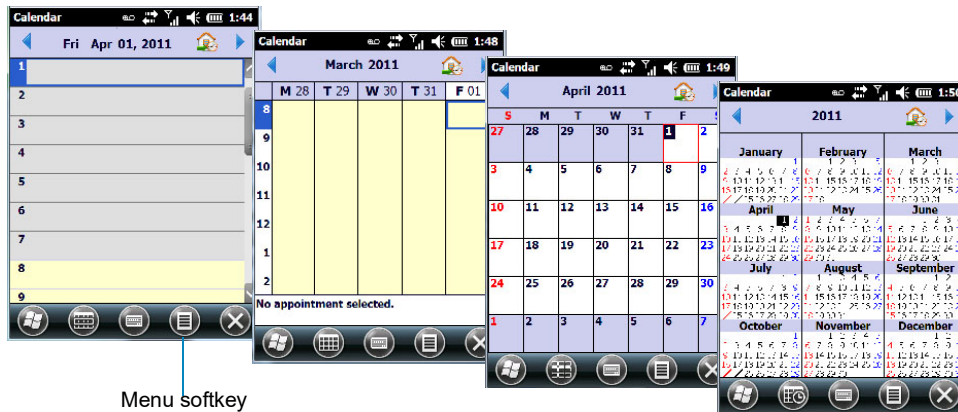

Creating and Editing Appointments

- In the Calendar screen, tap on the **Menu** softkey in the softkey bar, and then tap on **New Appointment**.

Figure 2-6 Appointment Detail Screen

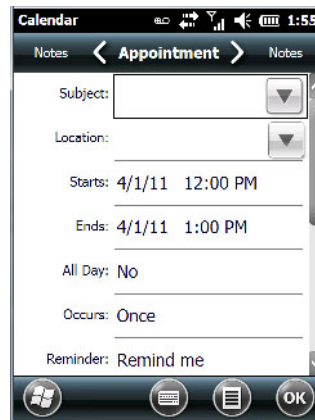

- In the Subject field, name the appointment.
- Complete the remaining fields to reflect your appointment details.

Adding Reminders

If you want to be reminded in advance of an appointment:

- Tap on the Reminder field, and choose **Remind me** from the drop-down menu.
- Tap the field below the Reminder field, and tap on the number in the field to display a drop-down menu where you can define a numeric value of 1, 5, 10, 15, 30. Tap on **minute(s)** to display a drop-down menu from which you can choose the time unit for your reminder – minute(s), hour(s), day(s) or week(s).
- Tap **OK** to finish. You are returned to the view you were in before adding the reminder.
- Tap the appointment in the **Calendar** screen to display it in a summary screen. The reminder is indicated by the small, bell icon.
- If you've no further additions for the appointment, tap on **OK**. Otherwise, move to the Categories section following.

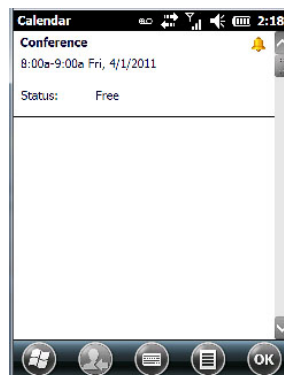

Using Categories

Categories help you organize and track the different types of data you keep on your Omnii.

To assign an appointment to a category:

- Tap on the **Menu** softkey, and choose **Edit**.

The Appointment tab is displayed.

- Scroll down to the **Categories** field, and tap on it to display your options.

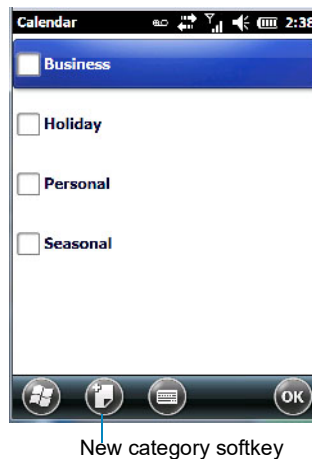

- Tap in the **checkbox** next to the **category** to which you want to assign the appointment.
- Tap **OK**. Your appointment is assigned to the category or categories you chose.

i **NOTE** You can create a new category by tapping on the New softkey at the bottom of the screen.

Attendees

This option allows you to define required and optional attendees for your meeting. When you tap on this option, your contacts are displayed where you can choose attendees.

Status

Tapping on Status lists your availability - Free, Tentative, Busy, or Out of Office.

Sensitivity

This option allows you to indicate the nature of the appointment – Normal, Personal, Private, or Confidential.

Deleting Appointments

- Tap and hold the stylus on the **appointment** you want to delete.
- Tap on **Delete Appointment** in the pop-up menu.

Favorites

Tapping on the Favorites option in the Today screen connects you to internet favourites. If you tap and drag your stylus on this option, you can choose Add/Remove to edit your list of favourites.

Using the Navigation Bar and Hotkeys

The navigation bar along the top of the screen provides access to icons or hotkeys that, when tapped, provide shortcuts to associated apps.



Shift-State Indicator Icon

The navigation bar at the top of the screen can also display the shift-state indicator icon. This icon indicates active modifier keys – [SHIFT], [ALT], [CTRL], [SYM] and [BLUE/FN].

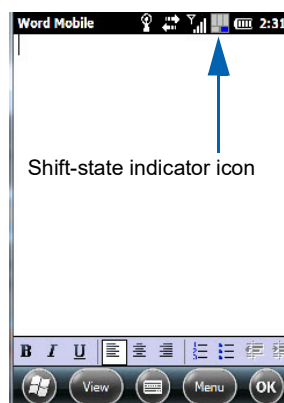

When a modifier key is pressed, it is displayed in the shift-state indicator icon. In the example above, the [BLUE/FN] key was activated.

To distinguish a 'locked' modifier key – a key that has been locked 'on' – from a modifier key that is only active until the next key is pressed, 'locked' keys are encircled in a black frame in the shift-state indicator icon. Refer to "[Activating Modifier Keys](#)" on page 2-9 for details.

The Softkey Bar

The Omnii is equipped with a softkey bar at the bottom of the screen. It displays softkeys that allow you to access menus and commands. Note that the softkeys change to reflect the program with which you are working. It also displays the soft keyboard icon.

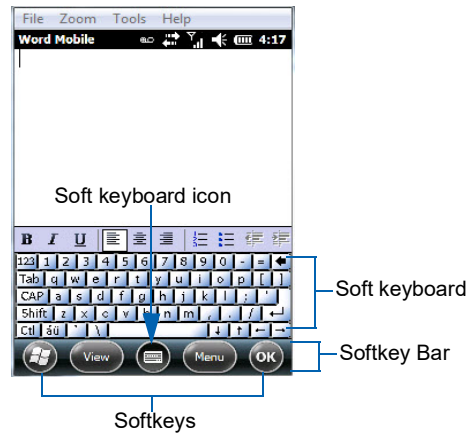

Softkeys

Tapping on a softkey displays information associated with the softkey – for example, in the sample screen above, the Menu softkey displays the commands associated with Word Mobile. The View softkey allows you to tailor how the Word document will be displayed.

The Soft Keyboard Icon

Tapping on the soft keyboard icon displays an onscreen keyboard you can use as an alternative to the Omnii keyboard.

The Start Button

The Start button provides access to a screen of applets available on your Omnii.

- Tap on the **Start** button in the lower-left corner of the softkey bar to display your programs.

Managing Files and Folders

Windows Embedded Hand-Held 6.5 files are stored in folders and sub-folders that are accessible with File Explorer. You can open, save, rename, copy and paste files in the same manner as you would on any desktop PC.

- Tap on the **Start** button.
- Use the stylus to scroll to the **File Explorer** icon.



- Tap on the icon to display the File Explorer screen.

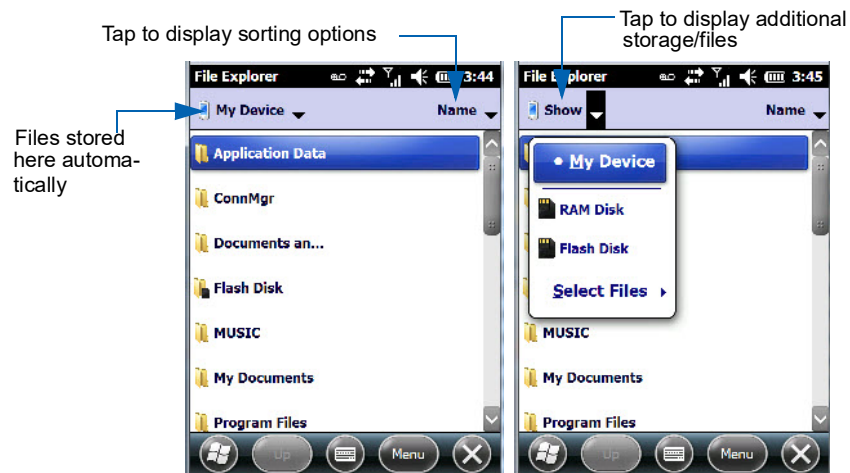

Creating a New Folder

- Tap **Start>File Explorer**.
- Tap the **Menu** softkey, and in the pop-up menu, choose **New Folder**.
- Use the Omnia keyboard or the soft keyboard to assign a name to the folder.

Renaming a File

- Press and hold the stylus on the file you want to rename. A ring of dots is displayed followed by a pop-up menu.
- Tap **Rename**. The file name is highlighted. Type a new name.

Copying a File

- Press and hold the stylus on the file you want to copy. A ring of dots is displayed followed by a pop-up menu.
- Tap on **Copy** in the pop-up menu.
- Navigate to the location where you want to copy the file.
- Press and hold the stylus in a blank area of the screen – away from other icons – until a pop-up menu is displayed.
- Tap **Paste** to copy the file to the new location.

Deleting a File

- Press and hold the stylus on the file or folder you want to delete until a pop-up menu is displayed.
- Tap **Delete** to remove the file.

Using Menus

In Windows Embedded Hand-Held 6.5, the menu is located in the softkey bar at the bottom of the screen.

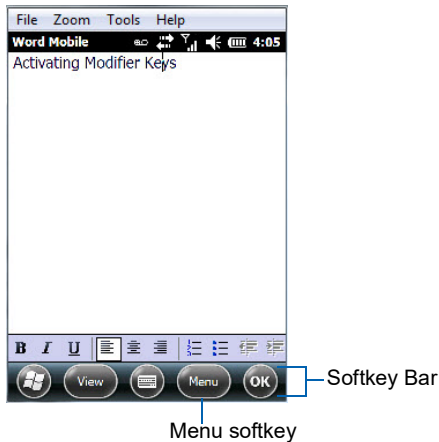

To execute a command:

- Tap on **Menu** to display the commands associated with it, and then tap on the command you want to execute.

Pop-Up Menus

Pop-up menus are available in many screens and programs. They offer quick access to a group of useful commands in addition to those available in the menu bar. To display a pop-up menu:

- Gently press and hold the stylus on the screen. A ring of dots is displayed on the screen followed by a pop-up menu.

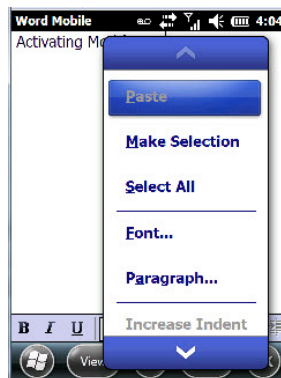

- Tap on the **command** you want to execute.

Programs – Using Applications

- Tap the **Start** button in the softkey bar to display the programs installed on your Omnii.

Figure 2-7 Program Icons



Opening an Application

- Tap on a **Program** icon to launch the associated program.

Minimizing an Application

- Tap on the **X** button in the lower-right corner of an application screen to minimize the application.



NOTE Although it looks like a Close button, this button does not close the application – it only minimizes it.

Opening, Closing and Switching Applications

- Tap on **Start>Settings>System** icon. Use your stylus to scroll to the **Task Manager** icon.
- Tap on **Task Manager** to display the associated screen.

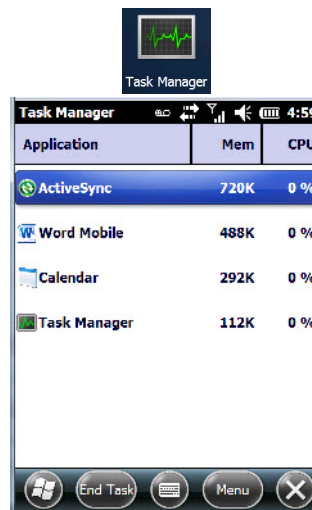

The Task Manager screen lists all running tasks (applications). This applet provides a number of options to manage your opened applications.

- **End Task:** To shut down an application, **highlight the program** in the list, and tap on the **End Task** softkey in the softkey bar at the bottom of the screen.
- **End All Tasks:** To shut down all applications, tap on the **Menu** softkey, and choose **End All Tasks**.
- **Switch To:** To make an application listed in this screen active, highlight the application, and tap on **Menu>Switch To**.

For additional information about the Task Manager, refer to [“Task Manager” on page 4-97](#).

Settings

- Tap **Start** followed by the **Settings** icon to display the setting options for your Omnii.

Figure 2-8 *Settings Icons*

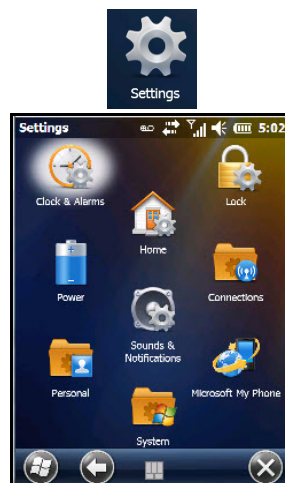

Along with icons that provide information about your unit and allow you to adjust the appearance and behaviour of your Omnii, an additional group of icons is stored in three folders – Personal, System and Connections. Refer to [Chapter 4: “Settings”](#) for details about the options available to you.

Kiosk

Kiosk allows the administrator to tailor how the Omnii operates and the options the user can access. Note that the look of the Today screen will change from icons that are finger accessible to a list of items that is best accessed using a stylus.



IMPORTANT For details about this application, refer to [“Kiosk” on page 4-76](#).

Data Transfer Between Omnii and a PC

Data transfer options vary slightly depending on the type of operating system installed in your PC.

For Windows XP SP2 operating systems or earlier, Microsoft® ActiveSync® connectivity software can be used to connect your Omnii to a PC.

If the Windows Vista®, Windows 7 or later, operating system is installed in your PC, ActiveSync is not required to transfer data between your Omnii and your PC.

By using a Snap Module or Desktop Docking Station with your Omnii, you can connect to a PC with a cable and:

- View Omnii files from Windows Explorer.
- Drag and drop files between Omnii and the PC in the same way that you would between PC drives.
- Back up Omnii files to the PC, restore them from the PC to the hand-held again, etc.

Uploading Data in a Docking Station

The Desktop Docking Stations allow your hand-held to upload transaction data to a server computer when a radio link is not available. When Omnii is properly inserted in a docking station, a dock icon is displayed in the navigation bar at the top of the screen.

Using Microsoft ActiveSync



NOTE If you use a serial port to connect devices like Omnii to your desktop computer, the connection may not succeed because ActiveSync has trouble connecting at non-default baud rates.

To work around this problem, set the ActiveSync baud rate on the desktop to use the same baud rate as the device. You can set the baud rate by editing the registry on the desktop host computer, as detailed in the steps outlined at the following website:

<http://support.microsoft.com/kb/324466>

To install ActiveSync, follow the step-by-step instructions provided with the setup wizard. For details, go to the following download center, and type ActiveSync into the search box:

<http://www.microsoft.com/downloads/en/default.aspx>

Using Windows Mobile Device Center

If you are running Windows Vista, Windows 7, or later, your data transfers do not require ActiveSync. Instead, you will need to download Windows Mobile Device Center. For instructions, go to the following download website and type the name into the search box:

<http://www.microsoft.com/downloads/en/default.aspx>

To transfer data between your PC and your hand-held:

- Tap on **Start>Computer** to display the drives. Omnii will be visible here.
- Open drives, files and folders as you would on your PC.

General Maintenance

Caring for the Touchscreen

The touchscreen is covered with a thin, flexible polyester plastic sheet with a conductive coating on the inside. The polyester can be permanently damaged by harsh chemicals and is susceptible to abrasions and scratches. Using sharp objects on the touchscreen can scratch or cut the plastic, or crack the internal conductive coating. The chemicals listed below must not come into contact with the touchscreen:

- mustard, ketchup
- sodium hydroxide
- concentrated caustic solutions
- benzyl alcohol
- concentrated acids

If the touchscreen is used in harsh environments, consider applying a disposable screen protector (RV6105). These covers reduce the clarity of the display slightly but will dramatically extend the useful life of the touchscreen. When they become scratched and abraded, they are easily removed and replaced.

Do not to expose the touchscreen to direct sunlight for prolonged periods of time. If this is unavoidable, use a UV screen protector to extend the life of the screen.

Cleaning the Omnii



IMPORTANT

Do not immerse the unit in water. Dampen a soft cloth with mild detergent to wipe the unit clean.

To prevent damage to the touchscreen, use only your finger or the stylus (pen) supplied with your Omnii.

- Use only mild detergent or soapy water to clean the hand-held unit.
- Avoid abrasive cleaners, solvents or strong chemicals for cleaning. The Omnii has a plastic case that is susceptible to harsh chemicals. The plastic is partially soluble in oils, mineral spirits, aircraft de-icing fluid, and gasoline. The plastic slowly decomposes in strong alkaline solutions.
- Exposure to aircraft de-icing fluids can degrade the plastics on the Omnii. If the Omnii is used near aircraft de-icing environments, regular rinsing with water is recommended.
- To clean ink marks from the keypad and touchscreen, use isopropyl alcohol.

CHAPTER 3 PROGRAMS

Programs	3-3
Home	3-3
The Phone	3-4
The Onscreen Phone Keypad	3-4
Sending & Ending Phone Calls Using the Onscreen Phone Keypad	3-4
Sending & Ending Calls Using the Omnii Keyboard	3-5
Making a Conference Call	3-5
Programming Speed Dial	3-5
Managing Phone Settings	3-8
Text Messages	3-8
E-mail	3-9
Folders	3-9
Synchronizing E-mail with Outlook (PC with Windows XP OS)	3-9
Changing Synchronization Settings	3-10
Synchronizing E-mail with Outlook (PC with Windows Vista or Windows 7)	3-11
Sending an E-mail	3-12
Contacts	3-12
Working with the Contacts List	3-13
Communicate Tab - Adding Contacts	3-14
Info Tab	3-15
Notes Tab	3-15
Internet Explorer	3-15
Browsing Web Sites	3-15
Calendar	3-16
Alarms	3-16
Pictures & Videos	3-17
Using the Camera	3-17
Moving Photos to the Omnii	3-18
Opening a Photo	3-18
Deleting a Photo	3-18

Editing a Photo3-19
Creating a Slide Show3-19
Using the Video Recorder3-19
Windows Media3-20
Messenger (Windows Live)3-20
Windows Live.3-21
Notes3-21
Creating a Note Using the Soft Keyboard3-21
Creating and Converting Handwritten Notes to Text.3-22
Renaming a Note3-23
Recording Notes3-23
Task Notification3-24
File Explorer3-26
ActiveSync®3-27
Synchronization.3-27
Internet Sharing3-27
Creating an Internet Connection3-27
Using Internet Sharing3-28
Task Manager3-29
Search Phone3-29
Imager and Camera Demo3-31
Office Mobile3-31
Excel Mobile3-32
OneNote Mobile3-32
Word Mobile.3-36
Text Input Modes3-36
Sharing Documents with your PC3-36
PowerPoint Mobile3-36
SharePoint Workspace Mobile3-37
PartnerUp.3-37
Kiosk3-37
Modem Link3-38
Remote Desktop Mobile.3-38
Connecting to a Terminal Server3-38
Disconnecting Without Ending a Session.3-39
Ending a Session.3-39
SIM Toolkit UI.3-39
WiFiConnect A.R.C.3-39

Programs

Omnii programs are all available from the Start screen.

- Tap on the **Start** button in the lower-left corner of the Today screen to display the Start screen.

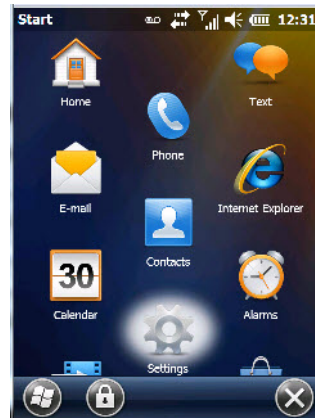

Tapping on an icon in this screen launches the associated applet.



IMPORTANT

For details about the options contained under the 'Settings' icon, refer to [Chapter 4: "Settings"](#).

Home

Tapping on the Home icon in the Start screen displays the Today screen.

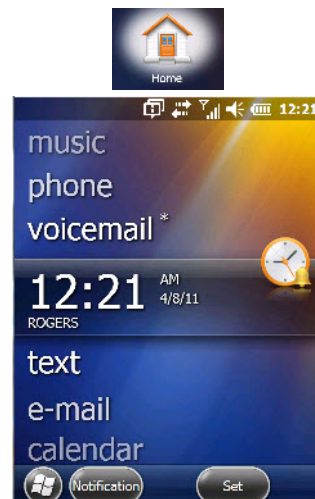

IMPORTANT

For details about the Today screen, refer to ["The Today Screen" on page 2-21](#).

The Phone

The Omnii can be equipped with optional phone capabilities. To access the phone pad on a unit that includes the phone option:

- Tap on **Start>Phone** icon.

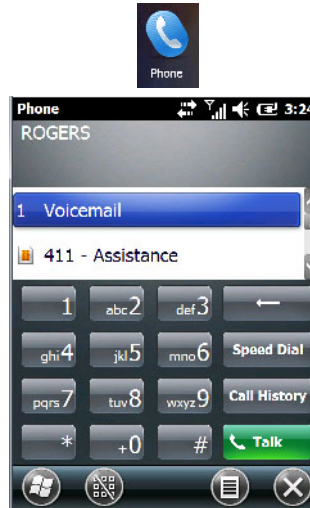

The Onscreen Phone Keypad

The onscreen phone keypad provides phone services like those you may find on your cellular phone. You can use the phone keypad provided with your Omnii to, for example, send and receive phone calls, make conference calls, view your call history, set up speed dial numbers, etc.

Sending & Ending Phone Calls Using the Onscreen Phone Keypad

To display the onscreen phone keypad:

- Tap on **Start>Phone** icon.



NOTE You can also press the [Talk] key on the Omnii keyboard to display the phone keypad providing it has been activated. The [Talk] key is labelled with a green telephone receiver icon.



To make a phone call:

- Use the phone keypad to enter the phone number. Tap on **[Talk]** to connect the call.

When you tap on the [Talk] button to connect to a phone number, the [Talk] button toggles to become the [End] button. When you've completed your call and want to disconnect:

- Tap on **[End]** button on the onscreen phone keypad.

Sending & Ending Calls Using the Omnii Keyboard

The 55-key and the 66-key Omnii keyboards come equipped with phone keys – each has a [Talk] and an [End] key on the physical keyboard.

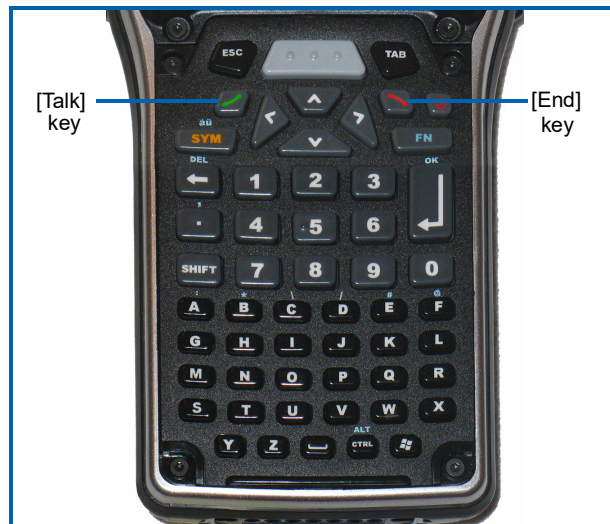

- Press the [Talk] key to answer a call or to display the onscreen phone keypad so you can initiate a call.
- Press the [End] key to terminate a phone call.

Making a Conference Call

To set up a conference call between yourself and two or more other parties:

- In the phone keypad, type the **first phone number**. Tap on **[Talk]**.
- While you are connected to the first number, tap on **Menu>Hold**.
- Type the **second number**. Tap on **[Talk]**.
- Tap on **Menu>Conference**.
- To add another party, tap on **Menu>Hold**, type the **number**, and then tap **Menu>Conference**.
- Tap on **[End]** to disconnect all calls.

Programming Speed Dial

The phone keypad provides a Speed Dial button for quick access to frequently used numbers.

- In the phone keypad, tap on the **Speed Dial** button to display the speed dial Phone dialog box.

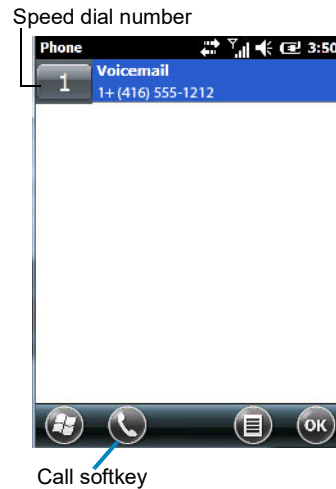

This dialog box lists the phone numbers and the speed dial key to which the phone number has been assigned.

- Tap on the **Speed Dial Number** (the number to the left of the phone number you want to dial), or
Tap on the **Call** softkey in the softkey bar at the bottom of the screen; the number is dialed for you.

Using the Phone Keypad to Program a Speed Dial

There are a number of ways to add a speed dial number. You can create a speed dial number using the Contacts list or by using the Speed Dial button on the phone keypad.

Adding a New Phone Number

- In the phone keypad, tap on the **Speed Dial** button.
- In the speed dial Phone dialog box, tap on **Menu>New**.
- In the list, choose a **contact** for a speed dial.

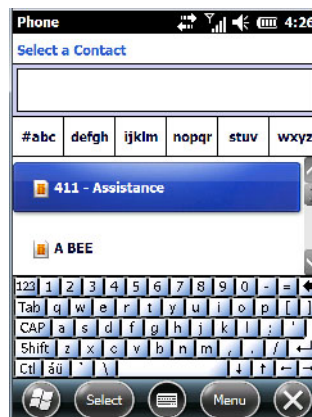

- Type a contact name in the field where the cursor is displayed, or tap on a name in the list.



A sequential speed dial key is automatically assigned in the Location field. You can tap on the arrows to the right of the Location field to change the auto assignment.

Using the Contact List to Program a Speed Dial

- Tap on **Start** followed by the **Contacts** icon.

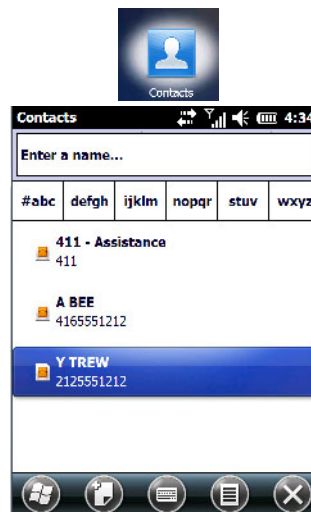

- Tap on the **Contact** to which you want to assign a speed dial number.

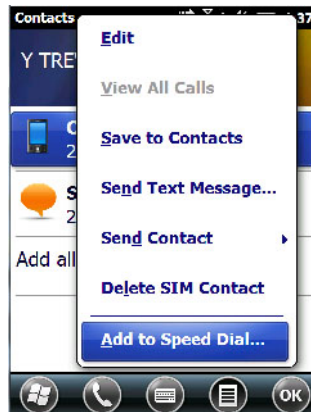

- In the Summary screen, tap on **Menu>Add to Speed Dial**.

Managing Phone Settings

You can adjust phone settings such as the ring type and tone, choose phone services such as barring calls, and you can also determine network selections.



IMPORTANT

For details, refer to [“The Phone – Managing Settings”](#) on page 4-51.

Text Messages

Tapping on the Text option in the Today screen displays this screen.

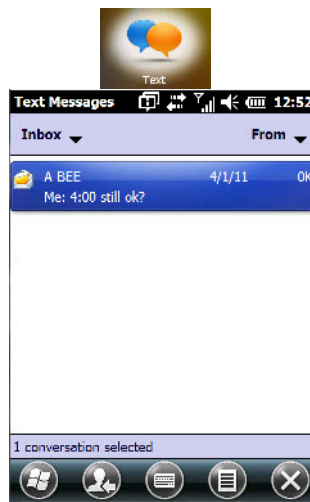

This option allows you to compose, send and receive text messages using your Omnii.



IMPORTANT

For details about using the Text Messages feature, refer to [“Text Messages”](#) on page 2-24.

E-mail

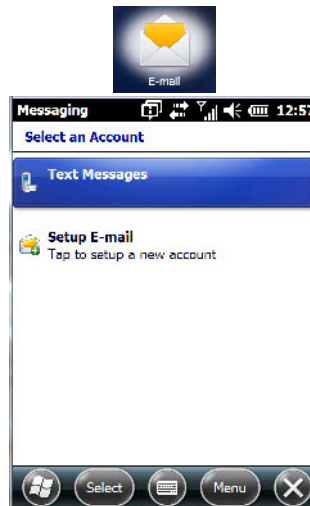

NOTE If your e-mail is already synchronized, go to [“Sending an E-mail” on page 3-12.](#)

The E-mail program is used to send and receive e-mail on your Omnii. It also provides access to text messages.

To send and receive e-mail, you’ll need to synchronize your PC or connect to a Post Office Protocol 3 (POP3) or Internet Message Access Protocol 4 (IMAP4) mail server.

For each of these methods, you need to set up an e-mail account with one exception – Outlook e-mail accounts are set up by default.

Folders

If you use an Outlook e-mail account, messages in the Inbox folder in Outlook are automatically synchronized with your Omnii. You can use ActiveSync on your PC to synchronize additional folders. The folders and messages you move are mirrored on the server.

For POP3 accounts, if you move e-mail messages to a folder you create, the link between the messages on the Omnii and the copies on the mail server are broken. When you next connect, the mail server will recognize that the messages are missing from the Omnii Inbox folder and delete them from the server, preventing duplication of messages. Keep in mind however that you will not have further access to messages that you moved to folders from anywhere except with the Omnii.

For IMAP4 accounts, the folders you create and the messages you move are reflected on the server, making messages available any time whether you connect to your mail server from your Omnii or your PC.

Synchronizing E-mail with Outlook (PC with Windows XP OS)



IMPORTANT For PCs running Windows Vista or Windows 7, follow the guidelines under [“Synchronizing E-mail with Outlook \(PC with Windows Vista or Windows 7\)” on page 3-11.](#)

By synchronizing the Omnii E-mail program with Outlook on your PC, your e-mail is available on both the Omnii and on your PC.



NOTE Synchronizing e-mail does not require that the Omnii have an independent connection to the Internet.

- In ActiveSync on your PC, tap on **Tools>Options** in the tool bar at the top of the screen.

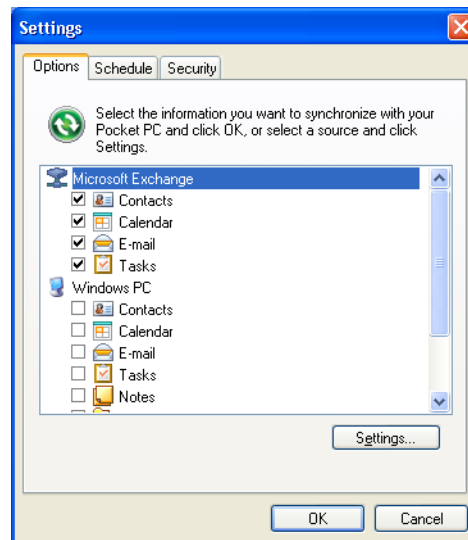

- Make certain that a check mark is displayed in the checkbox next to E-mail. Tap on **OK**.

Once you check E-mail for synchronization, Outlook e-mail messages are synchronized as part of the general synchronization process. The next time you synchronize with ActiveSync, the e-mail in Outlook on your PC will be transferred to the Messaging program on your Omnii.

Changing Synchronization Settings

- In ActiveSync on your PC, double-tap the **E-mail** item in the Sync Options tab.

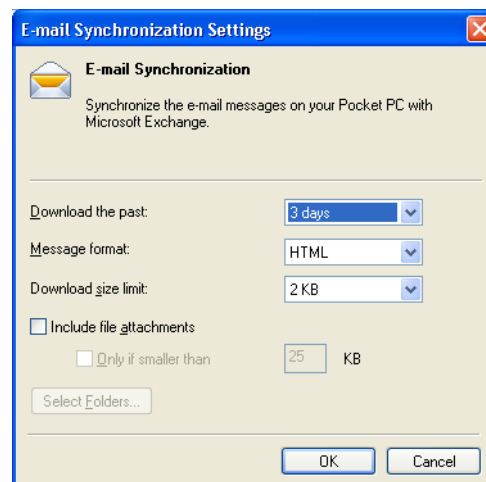

- Tap on the **Select Folder** button.

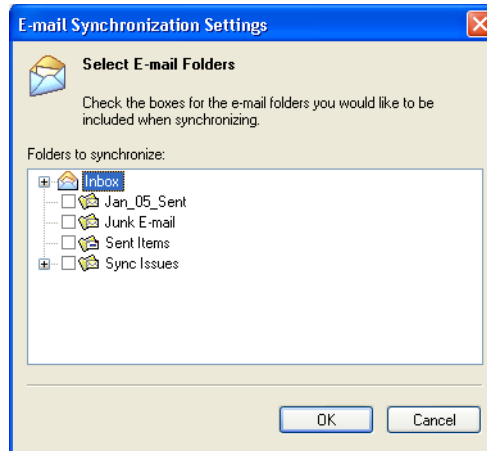

- Add a check mark next to the folders in this screen that you want to synchronize with your Omnia, and tap on OK.

The E-mail Synchronization screen is displayed again.

- If you want to accept file attachments, add a check mark next to Include file attachments. To limit the size, tap on Only if smaller than, and specify a size in the KB box.
- Tap on **OK**.

Synchronizing E-mail with Outlook (PC with Windows Vista or Windows 7)

PCs running Windows Vista or Windows 7 use Windows Mobile Device Center in place of ActiveSync.



- In the Windows Mobile Device Center, tap on **Set up your device**.

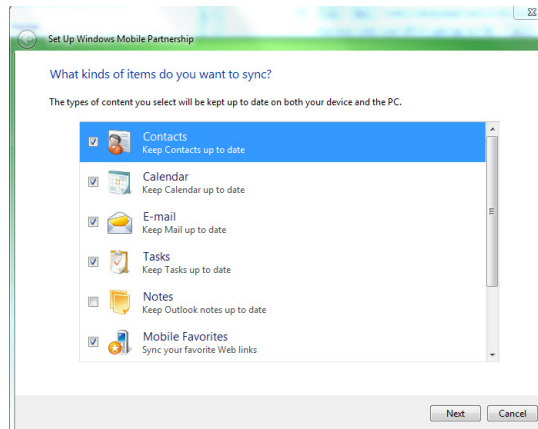

- Make certain that a check mark is displayed in the checkbox next to E-mail. Tap on **Next**.



NOTE If an Exchange Server is detected, a screen is displayed where you can enter the Server address, your user name and so on, and sync the Omnii with the Exchange Server directly over a cellular or wireless network when you are not connected to your PC. This is an optional step that you can skip.

- Tap on **Skip** and then tap on **Setup**.

When E-mail is checked for synchronization, Outlook e-mail messages are synchronized as part of the general synchronization process. The next time you synchronize with Windows Mobile Center, the e-mail in Outlook on your PC will be transferred to the Messaging program on your Omnii.

Sending an E-mail

E-mail messages are stored in the Outbox folder and are sent to recipients the next time you sync or connect to your e-mail server to send and receive mail.

- Tap on **Start>E-mail**.
- Choose the e-mail account you want to use.
- Tap on **Menu>New**.
- In the To, Cc, or Bcc fields, enter an **e-mail address**.

Keep in mind that you can also use your Contacts to choose an e-mail recipient provided an e-mail address is associated with the contact.

- Tap **Menu>Add Recipient**, and then choose a **contact** from the list.
- If you're sending an email to multiple people, use a **semicolon (;)** between addresses.

Contacts

Contacts are available with your e-mail, text messages, voice messages and your phone.

- Tap on **Start>Contacts** to display your contacts.

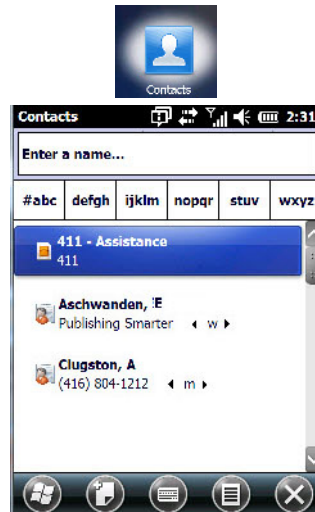

Working with the Contacts List

The Contacts screen allows you to work with existing entries, search for a particular contact and create new entries.

Contact Menu Commands

A Menu softkey at the bottom of the screen provides additional commands that allow you to work with the contacts in this list.

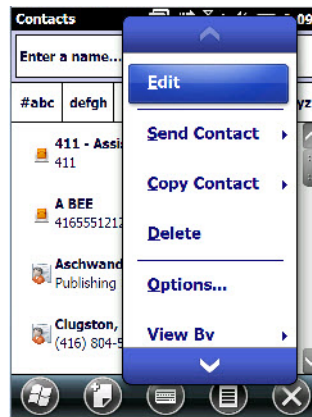

Menu

Searching for a Contact

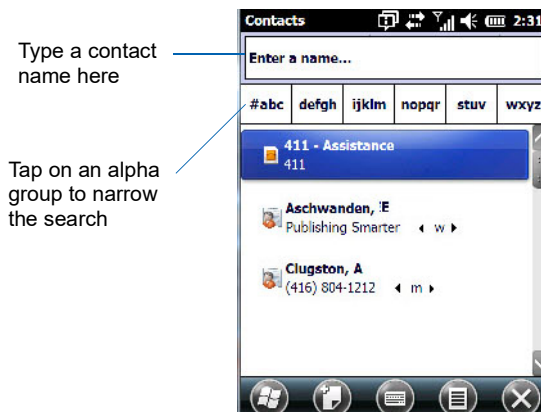

To search for a particular entry:

- Tap on the **Enter a name ...** field, and type the name you are searching for in the Contacts list.
- To narrow your search to names beginning with a particular letter, tap on the appropriate alpha character grouping.

Communicate Tab - Adding Contacts

Adding a New Contact

The New softkey located to the right of the Start softkey allows you to add additional entries to your contacts list.

- Tap on the **New** softkey.

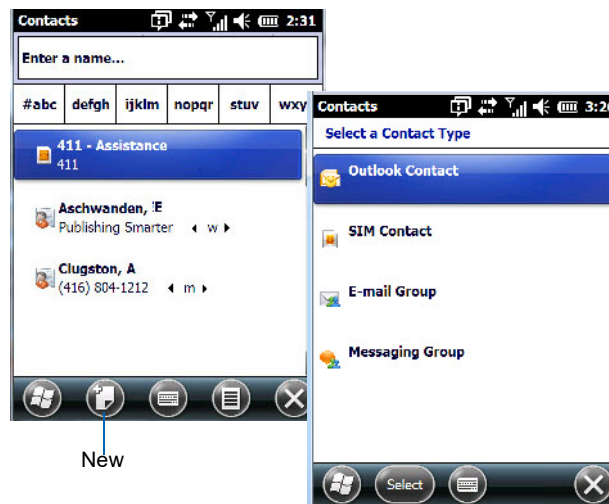

- Choose the **contact type** to which you want to add an entry.
- Tap on the **Select** button to display the Communicate screen. Tap on each of the options you want to complete for the new contact you are creating. Each item you tap on in this screen produces an associated pop-up screen in which you can enter the appropriate information. For example, in the sample screen following, tapping on Add a name displays an associated screen for you to complete.

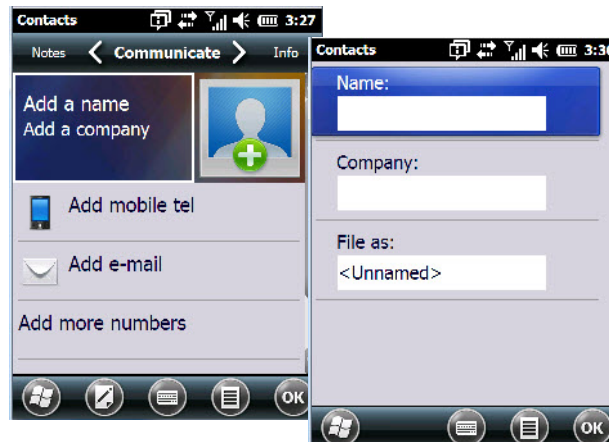

- When you've completed the information for the contact entry, tap on **OK**. The new contact is displayed in the Contacts list.

Info Tab

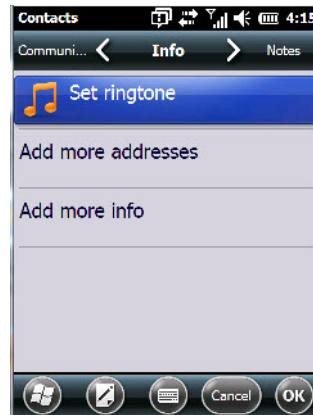

This tab allows you define a ring tone for a particular contact. You can also add additional addresses related to your contact (work and home), and information about your contact such as a job title, office location and fax number.

Notes Tab

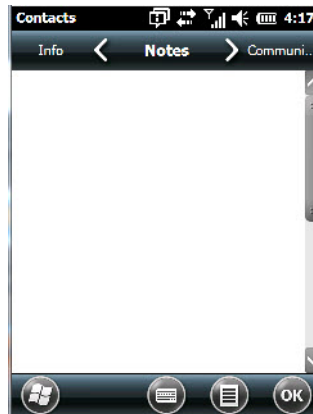

This screen allows you to enter useful information about your contact.

Internet Explorer

You can connect to Internet Explorer in two ways: by connecting the Omnii directly to the Internet or by connecting through your PC (see [“ActiveSync®” on page 3-27](#)).

Browsing Web Sites

There is little difference between the standard Internet Explorer found on your PC and that found on your Omnii, sometimes referred to as Pocket Internet Explorer. You can enter URLs, set a 'home page', turn images on and off, e-mail links to friends, and so on.

To go to a web site:

- Connect your Omnii to the Internet. (If you're not certain how to do this, refer to [“Connections – Connecting to the Internet” on page 4-23](#)).
- Tap on **Start>Internet Explorer** to open Internet Explorer.

- Tap on the address bar – the field near the top of the screen where URLs are entered – to highlight the current URL.
- Type a new URL in the address bar.

Tapping on the softkeys in the softkey bar at the bottom of the screen displays Internet Explorer commands like those you find on your PC.

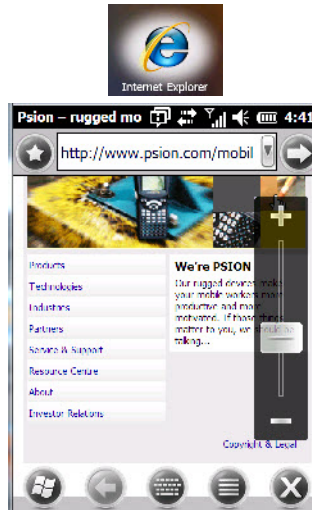

Calendar

This option is used to map out all your upcoming appointments, meetings and so on in the weeks, months and years ahead.

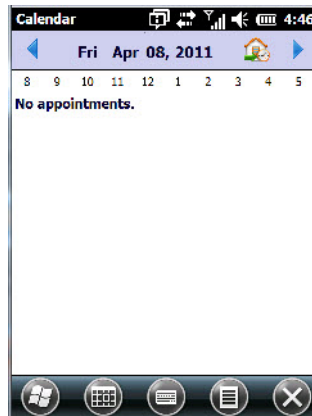

IMPORTANT

Refer to [“Calendar of Upcoming Appointments”](#) on page 2-26 for details about this feature.

Alarms

Refer to [“Time, Date and Alarms”](#) on page 2-23 for details about this applet.

Pictures & Videos

The Pictures & Videos applet allows you to snap photographs and record video footage. It is also a photo and video viewing program.



IMPORTANT

The Pictures & Videos program can only display .bmp or .jpg formats. Photos in other formats will need to be converted on your PC before they are transferred to the Omnii.

Using the Camera

- Tap on **Start>Pictures & Videos**.

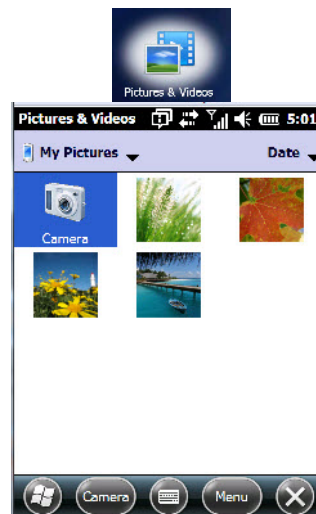

Keep in mind that if there are no pictures stored on your Omnii as yet, you'll only see the Camera icon in this screen.

- Tap on the **Camera icon** to activate the camera.

The screen will display the image your camera is pointed at. (The camera is built into the back of the Omnii.)

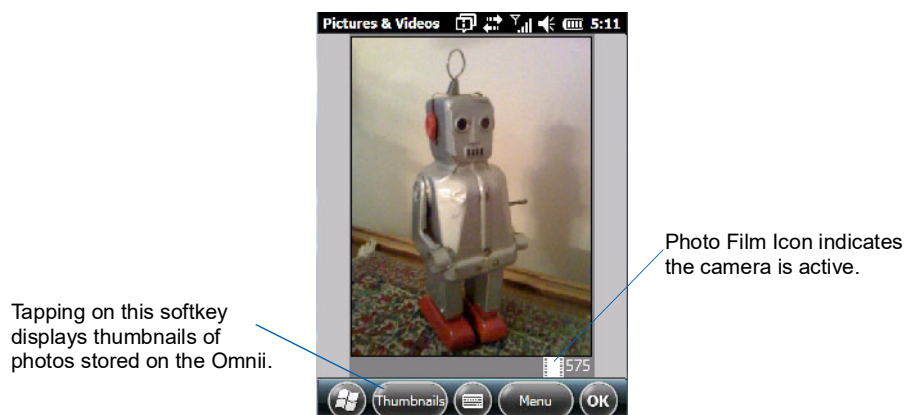

- Frame the image in the Omnii screen. Press **[ENTER]** to snap the photograph.

Photo Menu

When the camera is activated, tapping on Menu displays a set of commands to help you modify how your camera operates, the quality of the photos it takes, and so on. You can also use this menu to activate the video recorder rather than the still camera.

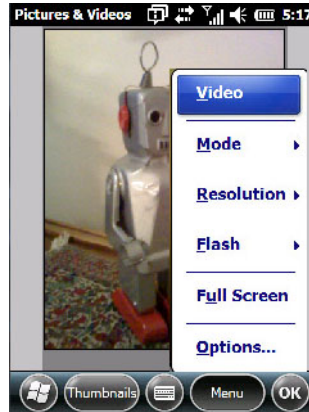

NOTE 'Video' is a toggle command. When the 'Still' camera is activated, 'Video' is available in this menu. When the video recorder is activated, 'Still' (camera) is available in this menu.

Moving Photos to the Omnii

- Connect your device to your PC with ActiveSync.
- Locate the pictures on your PC, and drag photos from their folder to the Mobile Device (Omnii). The Omnii can be found under Computer (My Computer on PCs running Windows XP).

Opening a Photo

- To open a photo, tap on **Start>Pictures & Videos**. You'll see a thumbnail of your photos.
- Tap on a thumbnail to open the photo.

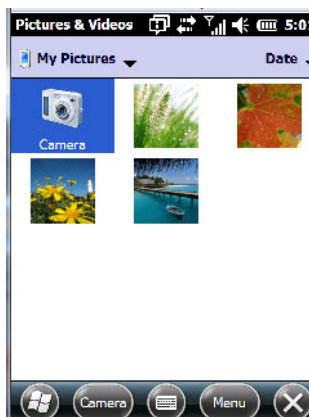

NOTE If you've stored your photos on a storage card, you'll need to tap on the storage card icon to display your photos.

Deleting a Photo

- Press and hold the stylus on the thumbnail photo you want to delete to display a pop-up menu. Tap on **Delete**.
- Confirm your choice when prompted.

Editing a Photo

- Tap on a thumbnail photo to open it.
- Tap on **Menu>Edit**.

The Rotate command is now displayed in the softkey bar. Additional editing tools are listed in the Menu.

Creating a Slide Show

To view a slide show:

- Tap on the **Menu>Play Slide Show**.

The slide show begins – in slide show mode, photos are displayed for about five seconds, one after the other.

- To display the slide show tool bar, tap anywhere on the photo.

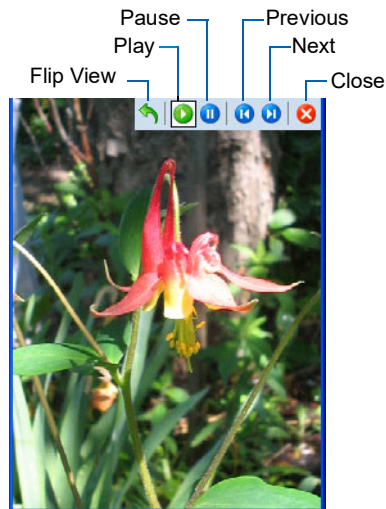

Using the Video Recorder

- Tap on the **Camera** icon.

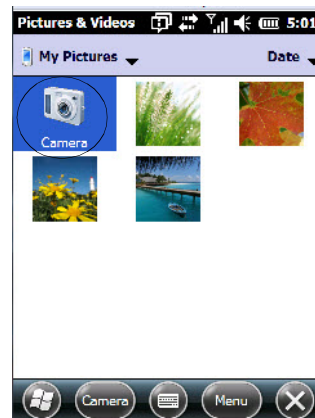

- In the bottom-right corner of the camera screen, tap on **Menu>Video**.

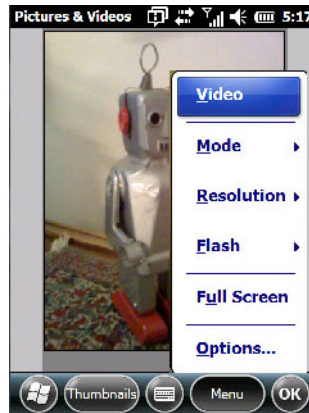

- Press **[ENTER]** to begin recording.



Video Recorder Icon
Indicates that video
is active.

- To end the video, press **[ENTER]** again, or tap on the **Stop** softkey.



NOTE When the 'Video' recorder is activated, a Menu is available to tailor the operation of the recorder, the quality of the recording, and so on.

Windows Media

Windows Media allows you to play music and videos on your Omnii. You can use Windows Media to play digital audio and video files that are stored on your Omnii or on the web.

- To work with this applet, tap on **Start>Windows Media**.

For details about using this applet, refer to:

<http://www.microsoft.com/windowsphone/en-us/howto/wp6/music/windows-media-player-mobile.aspx>

Messenger (Windows Live)

Windows Live Messenger is an instant messaging service. Refer to the Microsoft web site for details.

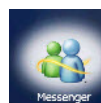

Windows Live

Windows Live is a free online service that provides operators with a free mobile phone back-up solution by wirelessly synchronizing contacts, calendar appointments, and so on with a password-protected online portal.

When you tap on Windows Live and accept the license agreement, a Setup screen is displayed. Follow the setup steps to set up your Windows Live ID so that you can begin using this service.

Notes

The Notes application is an electronic notepad you can use to jot down your ideas quickly. You can enter text using the soft keyboard, the Omnii keyboard, or you can create a handwritten note on the screen by using the transcriber. You can also record a message.

Notes can also be shared through e-mail and synchronization with your PC.

- Tap on **Start>Notes** to launch this application.

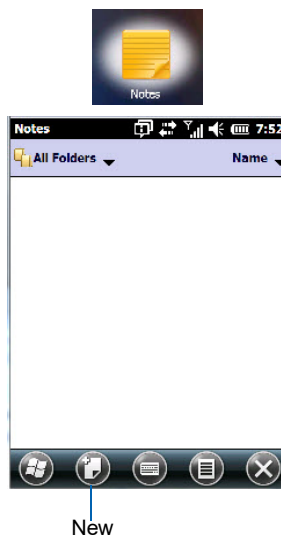

- Tap on the **New** softkey to display a blank note.

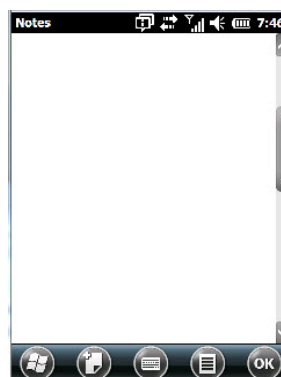

Creating a Note Using the Soft Keyboard

The soft keyboard icon is available by default. It is a replica of a standard keyboard. Use your stylus to type letters, numbers, symbols and so on.

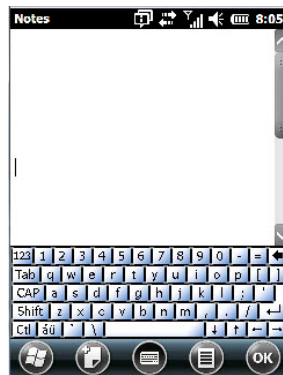

- When you've completed your note, tap on **OK**.

Your note is automatically saved. The file name is the first line of the note if you used the keyboard – otherwise, it's named Note1, Note2 and so on.

Creating and Converting Handwritten Notes to Text

To create a handwritten note using the transcriber:

- Tap and hold the stylus on the soft keyboard icon to display the pop-up menu.

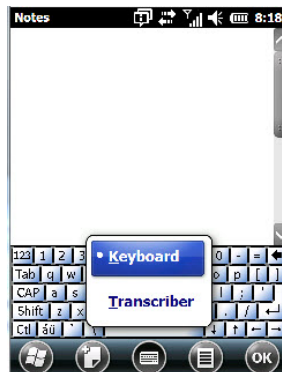

- Choose **Transcriber** from the menu.

When you choose Transcriber, you can write notes in your own handwriting. Omnii converts the notes into typed text for you.

A Transcriber Intro screen is displayed to provide information to help you work with the Transcriber.

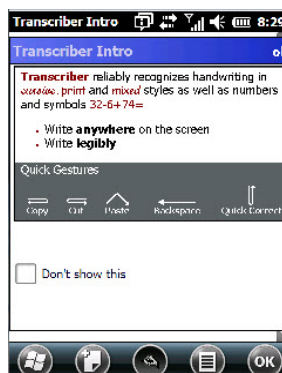

When you choose Transcriber, the soft keyboard icon changes to an icon of a hand poised to write a note.

- At the top of the Transcriber Intro screen, tap on **OK**.
- In the blank Note screen, use your stylus to write a note as clearly as possible.

The text in the note is converted from handwritten to printed text.

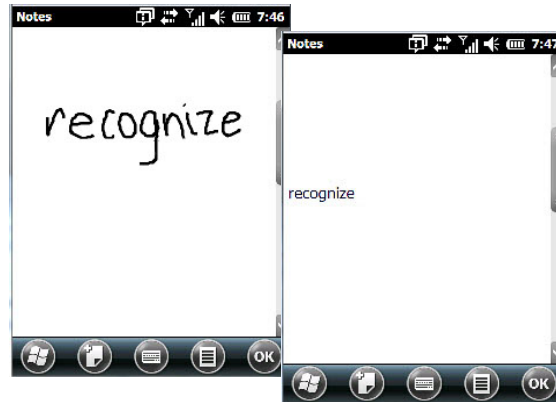

Renaming a Note

- Press and hold the stylus on the file name in the Notes screen that you want to rename. In the pop-up menu, choose **Rename/Move**.
- In the Name field, type the new name.



NOTE Remember that if you want to use the soft keyboard to type a new name, you'll need to tap and hold the stylus on the Transcriber icon, and choose Keyboard from the popup menu.

You can also move the note to a new Folder and/or a new Location.

- When you've made the changes you need, tap on **OK**.

Recording Notes

It is sometimes easier to record a note than to write it down just to make certain that you've captured an idea before it drifts away. To make an audio recording:

- Tap on the **New** softkey to open a fresh note.
- Tap on **Menu>View Recording Toolbar**.

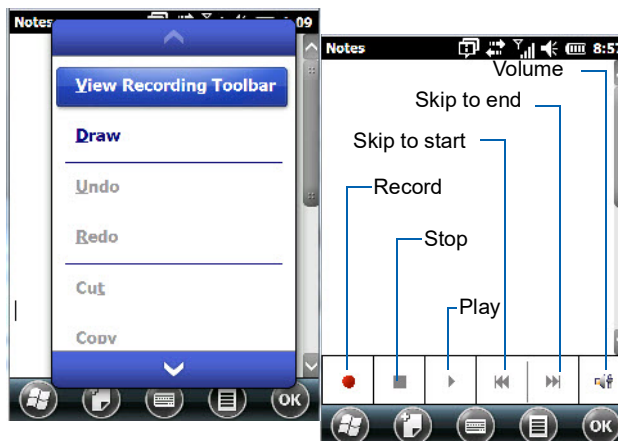

- Tap on the **Record** button – a beep alerts you that your device is now ready to record.

- Begin speaking into the microphone on the Omnii. Make certain that you move the Omnii to within a few feet of the source of the sound you want to record.
- Tap on the **Stop** button when you've completed your recording.
- Tap on **OK** to save the recorded note.

A speaker icon is displayed in the note indicating the presence of a recording within the note.

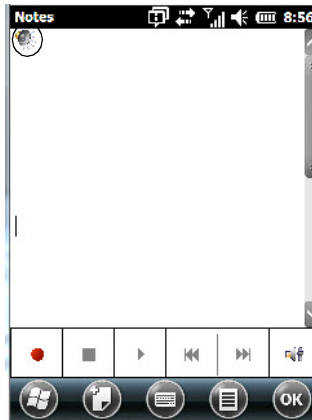

- To play the recorded note, tap on the **speaker icon**.
- Tap on **Menu**, and choose **View Recording Toolbar** again to turn off the feature.

Task Notification

Tasks lets you create lists of entries representing your responsibilities, upcoming projects, and so on. If you've assigned any tasks, this option lets you know how many active tasks you have.



NOTE You can synchronize the Task Notification option so that any tasks are displayed on your Omnii as well as your PC. Refer to [“Synchronizing E-mail with Outlook \(PC with Windows XP OS\)”](#) on page 3-9 and [“Synchronizing E-mail with Outlook \(PC with Windows Vista or Windows 7\)”](#) on page 3-11. Each section outlines how to synchronize options other than e-mail.

- Tap on **Start>Tasks** to display the Tasks screen.

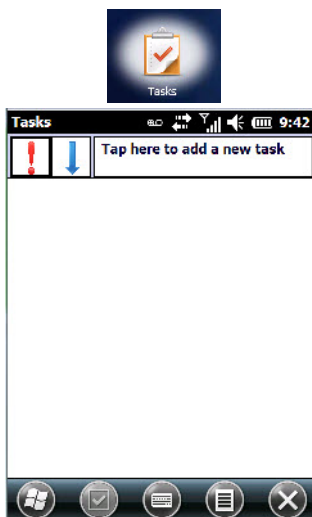

Creating a Task

- Tap in the field labelled **Tap here to add a new task**.
- Type your task description.

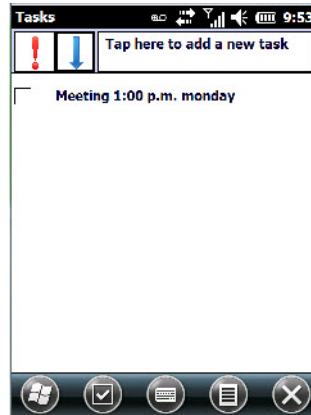

- Press **[ENTER]** to add the task to your list.

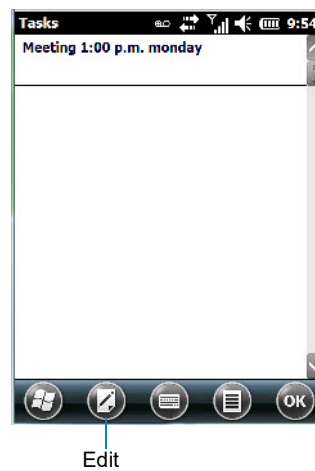

Editing a Task

- Tap on a **task** in the task you want to edit. Tap on the **Edit** softkey in the softkey bar to display a detailed task screen where you can define task characteristics.

Figure 3-1 *Task Details Screen*

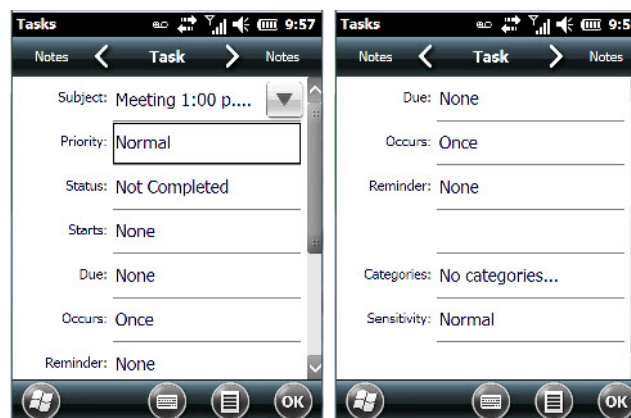

Each of the nine items in this screen, when tapped, displays a drop-down menu where you can choose from a list of options.

- Once you've completed all the appropriate fields, tap on **OK** to save your changes.



NOTE You can also tap on the Notes tab to add additional information about the task you are defining.

Deleting a Task

- Press and hold the stylus on a task until a pop-up menu is displayed.
- Tap on **Delete Task**.

Marking a Task as Completed

- In the **Tasks** list, tap the **checkbox** next to the items that are completed.

Sorting Tasks

- Tap on the **Menu** softkey, and tap on **Sort By**.

You can choose from **Status**, **Priority**, **Subject**, **Start Date** or **Due Date**. The tasks are arranged in the list according to the criterion you chose.

Limiting the Tasks Displayed in the Task Screen

- Tap on **Menu** in the softkey bar, and tap on **Filter**.

You can choose **All Tasks**, **Recently Viewed**, **No Categories**, **Active Tasks** or **Completed Tasks**. The tasks are displayed on the screen according to the preference you chose.

File Explorer

Windows Embedded Hand-Held 6.5 files are stored in folders and sub-folders that are accessible through File Explorer. You can open, save, rename, copy and paste files in the same manner as you would on any desktop PC.



IMPORTANT

Refer to [“Managing Files and Folders”](#) on page 2-31 for details about this feature.

ActiveSync®

ActiveSync® is Microsoft PC connectivity software that can be used to connect the Omnii to PCs running this software. You can synchronize the Omnii with your PC using this utility.

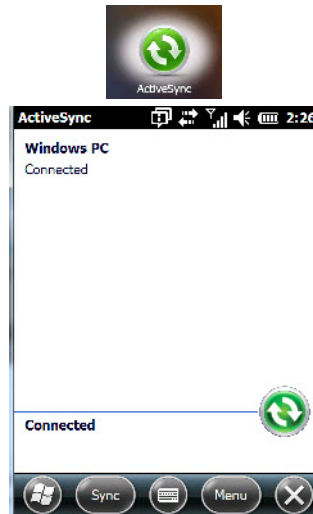

By connecting the Omnii to a PC through your desktop docking station and running ActiveSync or Mobile Device Center on your PC, you can view Omnii files, drag and drop files between the Omnii and the PC, connect to the Internet, and so on.

Synchronization



IMPORTANT

For information about using ActiveSync and Mobile Device Center on your PC, refer to “[Synchronizing E-mail with Outlook \(PC with Windows XP OS\)](#)” on page 3-9 and “[Synchronizing E-mail with Outlook \(PC with Windows Vista or Windows 7\)](#)” on page 3-11.

To download either ActiveSync or Mobile Device Center, visit the following Microsoft internet site:
<http://www.microsoft.com/windows-phone/en-gb/howto/wp6/sync/prepare-to-sync-windows-phone-6-5-with-my-computer.aspx>

Internet Sharing

This option allows you to use your Omnii to connect your PC to the Internet. Before you can use Internet Sharing, you must make certain that you have established a data connection on your Omnii.



Creating an Internet Connection

Follow the steps in this section only if you have not already setup an Internet connection.

You'll need the following information before you begin:

From your cellular service provider: data connectivity information, access point name and PAP/CHAP security settings.

From your Internet service provider (ISP) or wireless service provider: access point name and password and any additional security information.

For a GPRS, 1xRTT or dialup connection:

- Tap on **Start>Settings>Connections**. Tap on the **Connections** icon.
- Under My Work Network , tap **Add a new modem connection**.
- Type a **name** for the connection, and choose **Cellular Line (GPRS)**, or for 1xRTT connections, choose **Cellular Line**. Tap on **Next**.
- Type the **phone number** or **access point name** provided by your service provider, and tap **Next**.
- Type the **credentials** supplied by your service provider, and tap **Finish**.

Using Internet Sharing



NOTE Make certain that your data connection is running and that you can access the Internet from the Omnii. If you are using a USB cable to connect to your PC, you will need to disable the ActiveSync USB connection.

- On your PC, open the **ActiveSync** window, and tap on **File>Connection Settings**. If you are using Windows Mobile Device Center, tap on Mobile Device Settings>Connection Settings.
- Disable **Allow USB connection** by tapping in the checkbox to the left of this option.
- Connect the Omnii to your PC using Bluetooth or a USB cable.
- On your Omnii, tap **Start>Internet Sharing**.
- Choose the **PC Connection** type – USB or Bluetooth.
- Choose the **network connection** that the Omnii should use to connect to the Internet.
- Tap **Connect**. It takes approximately 30 seconds to establish a connection. (If you are prompted to turn on Bluetooth, tap **Yes**.)

For PC Running Windows XP or Earlier

If you are using a Bluetooth connection, execute the following steps on your PC:

- Tap **Start>Control Panel>Network Connections**.
- Right-click on **Bluetooth Network Connections**, and click on **Bluetooth Network Devices**.
- If the Omnii is listed as a Network Access Point, choose **Connect**. If it is not listed, choose **Create a new connection** and use the New Connection Wizard to add the Omnii to the list.

For PC Running Windows Vista or Windows 7

If you are using a Bluetooth connection, execute the following steps on your PC:

- Tap **Start>Control Panel>Network & Sharing Center**.
- Double-tap on **Set up a new connection or network**.
- In the Choose a connection option screen, double-click on **Connect to a Bluetooth personal area network (PAN)**.

A Devices and Printers screen is displayed.



NOTE Make certain that Bluetooth is enabled on your Omnii and that it is discoverable – on your Omnii, tap on Start>Settings>Connections. Tap on the Bluetooth icon. Scroll to the Mode tab. If they are not already enabled, tap in the checkbox (add an 'x') next to Turn on Bluetooth and **Discoverable**.

- In the Devices and Printers screen, tap on the **Add a device** button.

Your Omnii is displayed in the Add a device screen.

- Double-tap on your **Omnii** icon.

You are asked to choose a pairing option – Create a pairing code for me, or Enter the device's pairing code.

- If a pairing code has been assigned to your Omnii, choose **Enter the device's pairing code**, and type the **Omnii passcode** on your PC and on your Omnii.
- If a pairing code has not been assigned to your Omnii, choose **Create a pairing code for me**, and type the **Omnii passcode** on your PC and on your Omnii.

A message will appear on your Omnii indicating that you have successfully paired your Omnii with your PC. Your Omnii will appear in Control Panel>Devices and Printers.

Task Manager

The Task Manager screen lists all running tasks (applications) or processes. This applet provides a number of options to manage these.



IMPORTANT

For details about using the Task Manager, refer to [“Task Manager” on page 4-97](#).

Search Phone

This feature allows you to conduct a search through the data stored on your phone.

- Tap on **Start>Search Phone** icon.

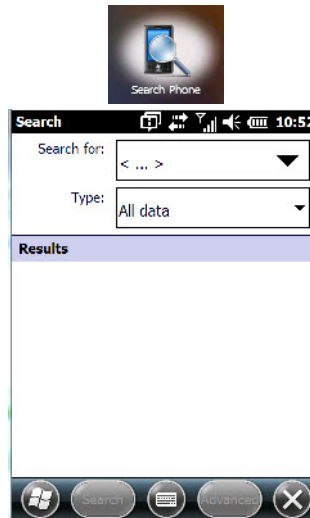

- Tap in the **Search For** field, and type the information or a fragment of the information for which you are searching.
- In the **Type:** drop-down menu, choose the location in which you want to conduct the search.

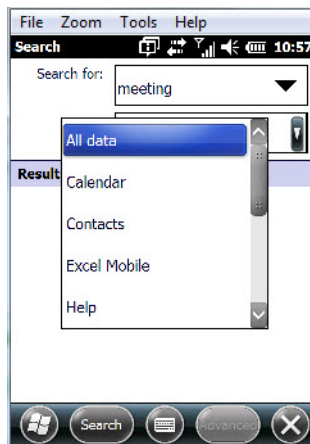

- Tap on the **Search** softkey key.

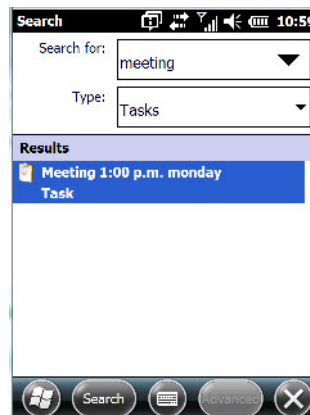

The results of your search are displayed in the Search screen.

Imager and Camera Demo

An Imager And Camera demo applet is provided to illustrate how the imager and camera work.

To launch the demo applet:

- Tap on the **Imager and Camera** icon.

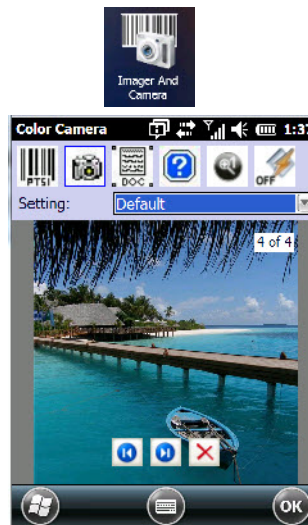

IMPORTANT

Refer to [Appendix B: "Imagers Applet"](#) for details about the imager applet.

Office Mobile

This icon contains the following abridged Microsoft programs: Excel Mobile, OneNote Mobile, PowerPoint Mobile, SharePoint Workspace Mobile and Word Mobile.



- Tap on **Start>Office Mobile**.



Excel Mobile

Excel Mobile is an abridged version of Microsoft Excel, an electronic spreadsheet program. If you're familiar with the Excel application on your PC, you'll be able to navigate Excel Mobile.

In addition to providing the tools to manipulate text and numeric values like statistics, percentages, using formulas that perform calculations, and so on, this program can also include graphics such as pie charts.

Excel Mobile allows you to copy Excel workbooks from your PC onto your Omnii and update them while you're away from your desk.

- Tap on **Start>Office Mobile>Excel Mobile**.
- If a list of workbooks is displayed rather than a new sheet, you'll need to create a new workbook. To create a workbook:
- In Excel Mobile, tap the **Menu>File>New**.

OneNote Mobile

You can use OneNote Mobile to take notes wherever you are and then synchronize your notes with a notebook section in the OneNote version on your PC. For example, you can:

- Snap pictures of business cards on your Omnii and then bring them into OneNote on your PC.
- Create short text notes and voice recordings on your Omnii to remind you about important meetings, ideas, etc. and synchronize them with your notes.
- Prepare information in OneNote on your PC and then transfer it to your Omnii where it will be available to you wherever you and your Omnii go.



IMPORTANT

Remember that you must have Microsoft Office OneNote 2010 and the latest version of ActiveSync or Windows Mobile Device Center installed on your PC before you can set up a partnership between your Omnii and your PC.

Setting Up a Partnership

- Start **Office OneNote** and **ActiveSync** or **Windows Mobile Center** on your PC.
- Connect the Omnii to your PC; you can use a USB cable or a Bluetooth connection.

When a connection is established between the Omnii and your PC, ActiveSync displays a New Partnership screen.



- Choose **Standard partnership**, and tap on **Next**.
- To share information between OneNote Mobile and Office OneNote 2010 on your PC, tap **Synchronize with this desktop computer**, and then tap on **Next**.
- Tap on **Finish** to begin the partnership between the Omnii and the PC. Now you'll be able to pass notes back and forth between your PC and your Omnii.

Creating A Note

- Tap on **Start>OfficeMobile>OneNote Mobile** icon. Tap on **New** in the softkey bar to display a blank note.
- Tap on **New** to create a note page. Begin typing.

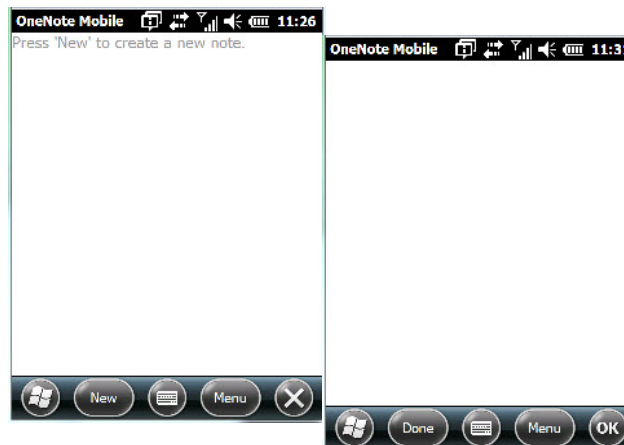

- When you complete your note, tap on **Done**.



NOTE Remember that you can tap on the Menu softkey to Undo typing, add Formats (Bold, Italic, Underline, Strikethrough), and include Lists (Numbered, Bulleted, Clear).

Using the OneNote Menu

Tapping on Menu displays a list of options to help you work with the OneNote Mobile applet.

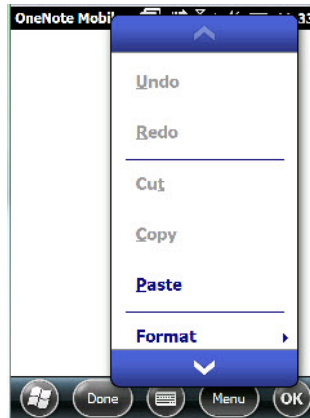

- **Undo, Redo, Cut, Copy and Paste:** These commands operate in the same way as they do in any Windows Office application.
- **Format:** Tapping on this command lists the formatting options you can apply to your note: Bold, Italic, Underline, Strikethrough and Clear All.
- **Take Picture:** When you tap on this option, the Omnii switches to camera mode so that you can snap a picture to include in your note.



Press **[ENTER]** to snap a photo that is automatically inserted into your note.

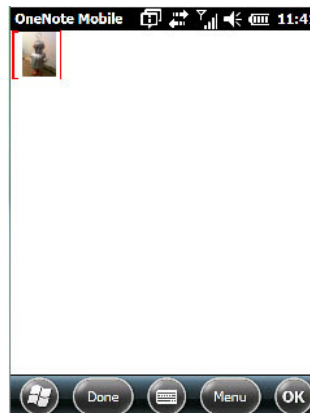

- **Insert Picture:** Tapping on this command automatically displays your My Pictures folder where you can tap on an existing picture to insert it into your note.
- **Insert Recording:** When you tap on this command, a recording panel is displayed.

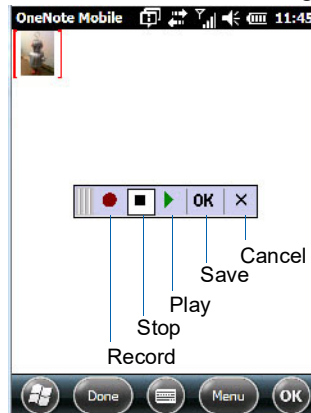

Tap on the **Record** button to record your message.

Tap on **Stop** when you've completed your message.

Tap on **Play** to listen to your voice message.

To discard your message, tap on **X** – the **Cancel** button.

To save your message, tap on **OK**. An audio icon is displayed in your note. You can tap on it to listen to your message.

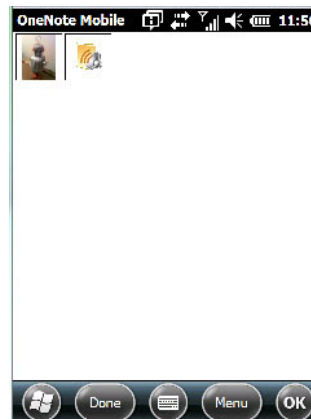

Synchronizing Omnii One Note With PC OneNote

- Connect the Omnii to your PC using either a USB cable or Bluetooth.

When the connection is complete, take one of the following steps:

- In Microsoft ActiveSync on your PC, choose **Sync**.
- or
- On your Omnii, tap on **Start>ActiveSync**, and then tap on **Sync**.

During synchronization, the notes you created on your Omnii are copied to a new Office OneNote 2010 notebook called OneNote Mobile on your PC. When synchronization is done, you can drag the transferred notes into any other sections and other notebooks on your PC.

Word Mobile

If you've used Microsoft Word on your PC, Word Mobile will be familiar to you. Keep in mind however that Word Mobile is designed for a small screen and limited memory.

i **NOTE** Keep in mind also that a Word document created on your PC can lose key formatting features such as styles and tables if you make changes to it on your Omnii.

- Tap on **Start>Office Mobile>Word Mobile**.



i **NOTE** If you've already created a Word document, it will be listed in a Word Mobile window. To launch a new Word document, you'll need to tap on the New softkey.

Text Input Modes

In addition to the soft keyboard, you can enter text using the Omnii keyboard, soft keyboard or the transcriber.



IMPORTANT Refer to [“Notes” on page 3-21](#) for details about the transcriber and soft keyboard text input methods.

Sharing Documents with your PC

Documents created on a PC are recognized by your Omnii. However, some formatting is lost when a Word document is converted to a Word Mobile document. This loss also occurs when you open a .doc file and change it on the Omnii.



IMPORTANT To avoid problems, work on copies of .doc files. In addition, keep in mind that you can use the Terminal Services Client program to log onto a desktop PC that is also running Terminal Services, and then you can use any program on your PC, including Microsoft Word (rather than Word Mobile).

Refer to [“Remote Desktop Mobile” on page 3-38](#).

PowerPoint Mobile

PowerPoint Mobile works just like the desktop version that may be installed on your PC. To launch this program on your Omnii:

- Tap on **Start>Office Mobile>PowerPoint Mobile**.

SharePoint Workspace Mobile

SharePoint Workspace Mobile allows you to open, edit, and save documents that are on a SharePoint site (a web site that lets you and others share and collaborate on documents, projects, schedules, and so on).

- Tap on **Start>Office Mobile>SharePoint Mobile**.
- Tap on the **Address** softkey to highlight the web address field. Type the **SharePoint address** you want to access.
- Tap on **Go** to access documents in the SharePoint site you specified.



NOTE To access a SharePoint site using SharePoint Workspace Mobile from inside your organization, you need to set up a Wi-Fi connection that lets you access a SharePoint site on your company's network.

PartnerUp

This app displays a number of pre-loaded applications. Tapping on an app in the list takes you to an associated web site.

The operator can then install the application. If a license is required, it can be obtained by sending an e-mail to the software license mailbox or by contacting a Sales Rep from the Zebra contact web page.

http://www.zebra.com/US-EN/Pages/Contact_Us/?WT.mc_id=psion_us_about_contact_psion-offices

Additional pieces of software such as a server must be obtained through Zebra.



Kiosk

Kiosk allows the administrator to tailor how the Omnii operates and the options the user can access. Note that the look of the Today screen will change from icons that are finger accessible to a list of items that is best accessed using a stylus.



IMPORTANT For details about this application, refer to “Kiosk” on page 4-76.

Modem Link

Modem link allows you to use the GPRS connectivity on your phone to connect your laptop or PC to the Internet.

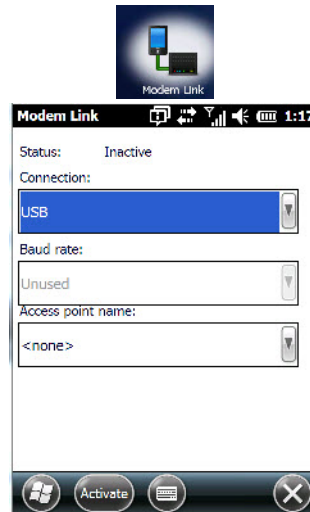

Remote Desktop Mobile

This program allows you to log onto a Windows Terminal Server and run the desktop programs from the server on your Omnii.

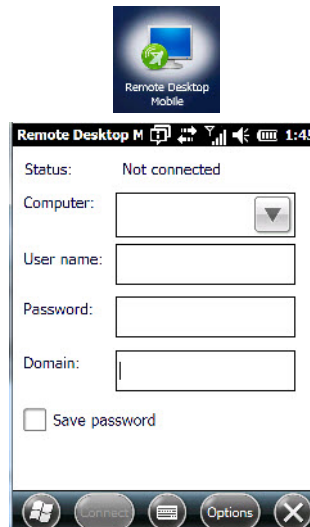

Connecting to a Terminal Server

- Tap on **Start>Remote Desktop Mobile**
- In the Remote Desktop screen, choose a **Computer** from the drop-down menu.
- Type your **User name**, **Password**, and **Domain** (if required). Tap on **Connect**.

Disconnecting Without Ending a Session



IMPORTANT

These commands are accessed from the Start menu in the Terminal Services screen used to access the PC's commands. Do NOT use the Start menu on your Omnii.

- In the Remote Desktop Connection window, tap on **Start>Shutdown**.
- Tap on **Disconnect>OK**.

Ending a Session

- In the Terminal Services Client screen, tap on **Start>Shutdown**.
- Tap on **Log Off>OK**.

SIM Toolkit UI



SIM Toolkit UI is an ETSI/SMG standard for Value Added Services and e-commerce using GSM phones.

The Omnii operator can, for example, check bank accounts and pay bills using a SIM Toolkit-enabled phone with an appropriate SIM Toolkit-specific SIM card which will provide much of the information required to conclude a transaction over GSM.

If this service is available in your organization, the system administrator can provide the setup information for your service.

WiFiConnect A.R.C.



- Tap on the **Start** button to access the WiFiConnect A.R.C. icon.

The WiFiConnect A.R.C. utility provides a quick method to configure a device for use on a private network, primarily for use with Active Remote Configuration (A.R.C.).

WiFiConnect A.R.C. configures the default WiFi interface. The WEP key is set to PsionPsion123. The SSID is set to Psion. The default interface becomes the active interface. Keep in mind that you must configure the access point and the hand-held(s) to use the same settings.

Refer to the Active Remote Configuration (A.R.C.) Administrators Guide, PN 8000252, for details about updating devices on your network. This manual is available at:

www.ingenuityworking.com/knowledge/w/knowledgebase/1189.a-r-c-active-remote-configuration.aspx

CHAPTER 4 SETTINGS

Overview of Software	4-5
Zebra Software Advantage	4-5
Microsoft Software	4-5
Settings	4-5
Clocks & Alarms	4-6
Lock	4-6
Home	4-7
Appearance Tab – Changing the Theme (Background).	4-7
Beaming a Theme to Another Device	4-7
Items Tab – Customizing the Today Screen	4-8
Power	4-9
Battery Power	4-9
Advanced Tab	4-9
Battery Details Tab.	4-10
Suspend Threshold and Estimated Battery Backup.	4-10
Battery Health	4-11
Sound & Notifications	4-12
Sounds Tab.	4-12
Notifications Tab	4-13
Connections Folder	4-13
Beam	4-14
Bluetooth Setup.	4-14
The Devices Tab - Scanning for Bluetooth Devices	4-15
Pairing a Device	4-17
Servers Tab.	4-18
Mode Tab	4-19
About Tab	4-20
Paired Tab	4-20
Connecting Using a Bluetooth GPRS Phone	4-21
Connections – Connecting to the Internet	4-23

Modem Connection Setup	4-24
Advanced Modem Settings.	4-25
Domain Enroll.	4-26
Network Cards	4-27
Changing Network Card Settings	4-28
VPN Connection Setup.	4-29
Managing an Existing Connection.	4-30
Proxy Server Tab	4-31
Selecting a Network	4-32
Wi-Fi Config - Setting Up the 802.11a/b/g/n Radio	4-33
Wi-Fi Config: Status Tab	4-34
Wi-Fi Config: Configure Tab	4-34
Configuring TCP/IP	4-39
Wi-Fi Config: Advanced Tab	4-41
Country Options	4-41
Wireless Manager	4-42
Personal Folder	4-43
App Launch Keys.	4-43
Buttons	4-45
Program Buttons Tab	4-45
Up/Down Control Tab.	4-46
OneShots	4-46
Macro Keys	4-47
Unicode Mapping	4-48
Scancode Remapping	4-49
Lock Sequence Tab.	4-51
The Phone – Managing Settings	4-51
Phone: Sounds Tab	4-53
Phone: Security Tab	4-53
Phone: Services Tab	4-55
Phone: Network Tab	4-55
Phone: Data Tab	4-56
Phone: Bands Tab	4-56
Phone: Diagnostics Tab	4-56
Phone: Hearing Aid Mode Tab.	4-57
System Folder	4-57
About	4-58
Backlight – Screen and Keypad	4-58
Battery Power Tab	4-59
External Power Tab.	4-59
Backlight Tab	4-60
Certificates	4-60
Choosing a Certificate	4-60
Compass	4-62

Contrast	4-63
Customer Feedback	4-63
Dr. Debug	4-63
Status	4-64
Utilities	4-64
Motion Meter	4-65
Settings	4-65
Encryption	4-65
Error Reporting	4-66
GPS (Global Positioning System)	4-66
GPS (Global Positioning System) Settings	4-68
Imagers Settings	4-71
Manage Triggers	4-72
Trigger Mappings	4-72
Managed Programs	4-74
Memory	4-74
Main Tab	4-75
Storage Card	4-75
Microphone	4-75
PartnerUp	4-76
Quick Defrost (Heater Settings)	4-76
Kiosk	4-76
Kiosk Menu	4-77
Administrator Password	4-78
Shell Settings	4-78
Restrictions	4-83
Control Panel Settings	4-84
Import and Export Settings	4-85
Activating a Change – User Mode	4-87
Regional Settings	4-87
Remove Programs	4-88
Scanner Settings	4-89
Restoring Default Settings	4-89
Options Tab	4-89
Translations Tab	4-92
Port Replicator Port A (COM5) and Port B (COM6)	4-93
Screen	4-95
Screen Rotation	4-96
System Properties	4-97
Task Manager	4-97
Total Recall	4-98
Creating a Backup	4-99
Creating a Clone	4-100
Managing Profiles	4-101

Deleting a Profile	4-103
TweakIT	4-103
Advanced Interface and Network Settings	4-104
Advanced Services Settings	4-105
Registry Editor	4-106

Overview of Software

Zebra Software Advantage

Zebra Software Advantage is a collection of applications and features designed to support system administrators and end users. These tools enable enterprises to customize the product to meet their needs and to maximize productivity.

- AGPS
- Zebra Camera
- App Launch Keys
- Kiosk
- Battery Health
- TweakIt
- Bluetooth Manager
- Scanner
- Compass
- Dr. Debug
- Total Recall
- PartnerUp
- Manage Triggers
- WiFiConnect A.R.C.
- Wi-Fi Config

Microsoft Software

Windows Embedded Hand-Held (WEH) 6.5 is a 32-bit, real-time Operating System. The OS is compatible with line of business applications written for Windows Mobile 6.x that protects previous investments in the Windows Mobile platform.

Some other major components of WEH 6.5 are:

- Office Mobile 2010 (Word, Excel, PowerPoint, OneNote SharePoint)
- Internet Explorer 8
- Remote Desktop protocol

Settings

The applets contained under the Settings icon in the Start screen allow you to tailor how your Omnii behaves, the appearance of the Today screen, and so on. The Settings applications are further divided into Personal, System, and Connection options.



Clocks & Alarms

Refer to “[Time, Date and Alarms](#)” on page 2-23 for details about this applet.

Lock

This option allows you to assign a password to protect access to your phone service.

- Tap on **Start>Settings**, and then tap on the **Lock** icon.

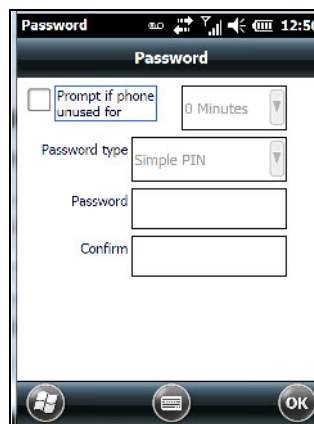
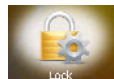

It is critical that you store your password in a safe place. If you forget it, a ‘clean start’ must be performed by certified Zebra personnel. A clean start returns the Omnii to factory settings. Only the data stored in a CF or SD memory card are preserved.

- Tap in the checkbox next to **Prompt if phone unused for** to turn on password protection for your phone service.
- Choose the amount of time that the unit can remain idle before you are prompted to enter your password.

- In the Password type drop-down menu, choose the type of password you prefer to assign. Simple PIN allows you to enter a minimum of four numeric characters. Strong alphanumeric requires a minimum of 7 characters and must contain at least three of the following: uppercase and lowercase alpha characters, numbers and punctuation.
- Type your password in the **Password** field.
- Retype your password in the **Confirm** field.
- Tap on **OK**. A dialog box asks whether or not you want to save your password settings. Tap on **YES** to save your password assignment.

Home

The Home applet is used to customize your Today screen.

- Tap on **Start>Home** icon to display this applet.

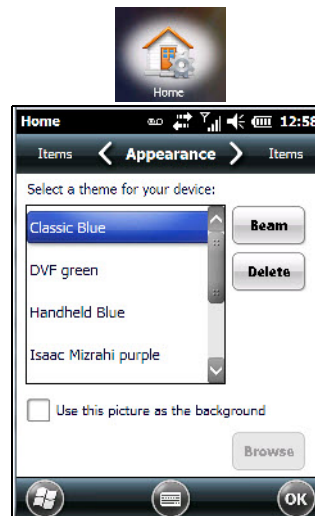

Appearance Tab – Changing the Theme (Background)

The Appearance tab allows you to change the background appearance of the Today screen.

- Tap on the **theme** or background you want to use. Tap on **OK** to assign the background you've chosen to your Omnii.



NOTE You can also use a personal picture as your background. Tap on the checkbox to the left of Use this picture as the background, and tap on the Browse button to locate your picture.

Beaming a Theme to Another Device

You can also beam your selection to another device. To scan for visible devices and beam a theme:

- Choose a **theme** or background, and tap on the **Beam** button.

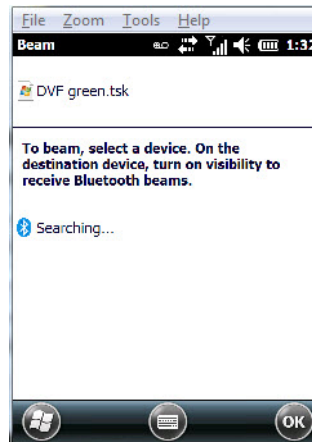

The Omnii scans for visible devices within range of the hand-held and lists them in the Beam screen.

- Tap on the device to which you want to send the theme.

A File Receive Confirmation dialog box appears on the device to which you are beaming the theme. If the recipient taps on **OK**, the file is downloaded onto their device. Note that the recipient can also tap on Browse to store the theme file in a different location.

Once the recipient clicks on OK to accept the file, the device you chose is marked as Done.

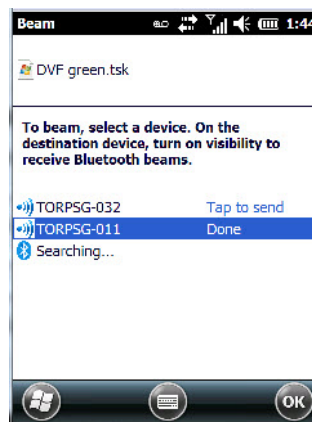

Items Tab – Customizing the Today Screen

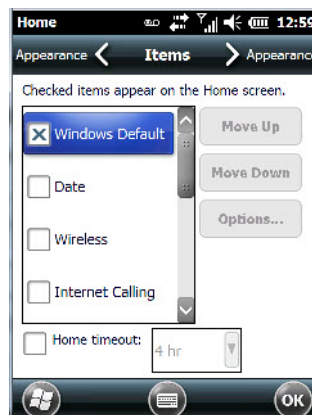

The items you see in the Today screen are Windows Default items. The Items tab allows you to customize the screen to suit your purposes.



NOTE Refer to “Customizing the Today Screen” on page 2-22 for details about this screen.

Power

The Power applet provides information about the battery installed in your Omnii, and it allows you to define the behaviour of your Omnii to minimize power consumption.

- Tap on **Start>Settings>Power** icon.

Battery Power

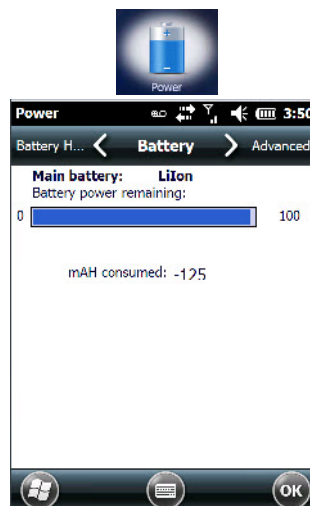

This tab monitors and displays the current battery capacity of the battery installed in the Omnii.

Advanced Tab

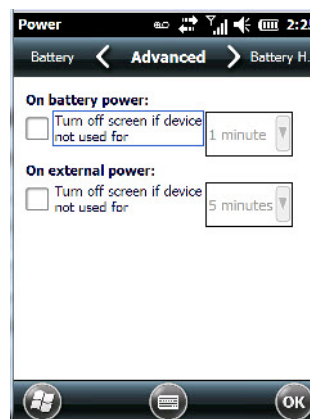

This tab allows you to tailor how long the Omnii can remain idle before the screen is turned off while running on battery power and also on external power.

i **NOTE** The options in the screen behave like Suspend mode. If the screen turns off, the unit is in suspend mode – tapping on the touchscreen or pressing a key opens the screen in which you were working before it was ‘turned off’.

- To determine behaviour when the unit is running On battery power, tap in the checkbox to the left of **Turn off screen if device is not used for**.
- Tap in the drop-down menu next to this option, and choose the number of **minutes** the unit can remain idle before the screen is turned off.
- To determine behaviour when the unit is running On external power, tap in the checkbox to the left of **Turn off screen if device is not used for**, and choose a value in the associated drop-down menu.

Battery Details Tab

- In the scrolling tab bar, tap on the **Battery Details** tab.

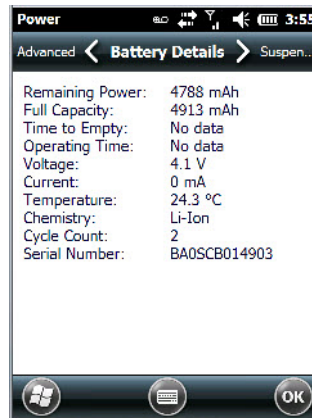

This tab lists the specifications and battery capacity status of the battery installed in the Omnii. This is a view-only screen.

Suspend Threshold and Estimated Battery Backup

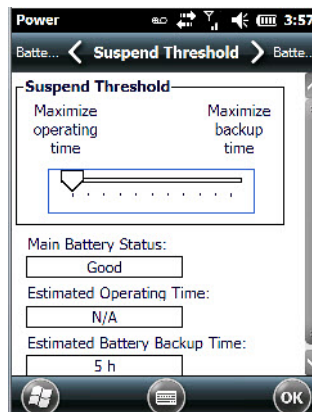

The Estimated Battery Backup is the amount of battery power that has been reserved or set aside to protect data until a fully charged battery can be installed in the Omnii. When the battery capacity is depleted up to the Estimated Battery Backup Time reserve specified in the Suspend Threshold tab, the Omnii shuts off automatically and uses the reserve power to preserve the data stored on the Omnii. Once the unit shuts down, it cannot be switched on until a fresh battery is installed, or the unit is inserted in a docking station or cradle.

- Slide the **Suspend Threshold** button to the right to increase the battery capacity reserved for backup purposes. Data will be preserved to a maximum of 100 hours.
- Slide the **Suspend Threshold** button to the left to decrease the power reserved for backup purposes; this increases the Omnii operating time – the amount of time the Omnii will operate before shutting down – but reduces the power reserved for backup purposes to a minimum of 24 hours.

Internal super-capacitors will protect the data stored in the Omnii while the depleted battery is swapped for a fully charged one.



NOTE Once the battery is removed, the super-capacitor will preserve the data stored on the Omnii for approximately 4 minutes. It is critical that you install a charged battery before this time elapses.

Battery Health

The Battery Health tab provides an estimate of battery health based on a number of different measurements, beyond battery capacity.



IMPORTANT The Battery Health Meter is an estimate and should not be depended on to provide a 100% account of battery condition.

- In the scrolling tab bar, tap on the **Battery Health** tab.

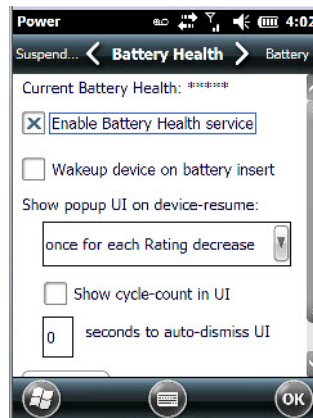

Current Battery Health Meter

The Current Battery Health Meter default values are shown here as ***** (Excellent), *** (Used), and * (Battery should be replaced).

To display the Battery Health Meter:

- Tap on the **navigation bar**, scroll to and click on the **battery hotkey**.

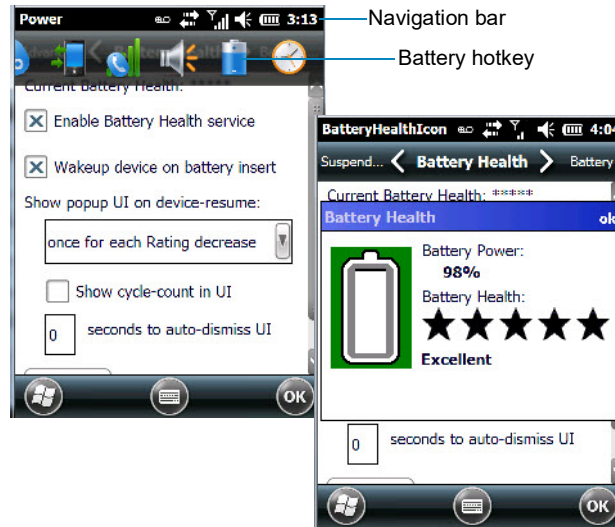

The image above shows the default Excellent status screen.

Enable Battery Health Service

This option allows you to enable or disable the battery health service.

Wakeup Device on Battery Insert

When this option is enabled, whenever the battery is replaced, the Omnii is powered up from a suspend state and the current health of the battery is displayed.

Show Popup UI on Device-Resume

The drop-down menu attached to Show Popup UI on Device-Resume allows you to determine when the battery status pop-up user interface (UI) will appear based on the battery health.

Edit – Changing Ratings Text

You can customize the ratings text with the Edit button. By enclosing your text within the html tag used for Bold (or removing the tag to unbold the text), you can change the text that will appear in the pop-up battery status screen. For example, the default text Excellent might be changed to: Battery is excellent, and will last one day shift.

Sound & Notifications

The Sounds & Notifications icon allows you to specify when your Omnii will emit sounds.

Sounds Tab

- Tap on **Start>Settings**, and then tap on the **Sounds & Notifications icon** to display this dialog box.

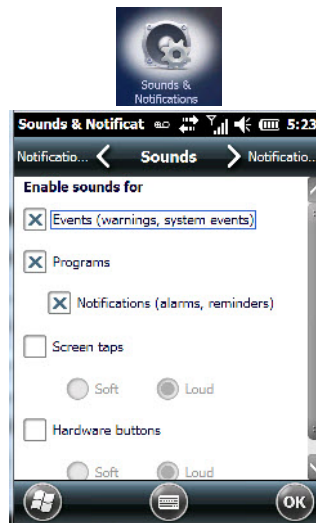

- Tap on the **checkboxes** and **radio buttons** to enable the event(s) that will cause your unit to emit a sound.

Notifications Tab

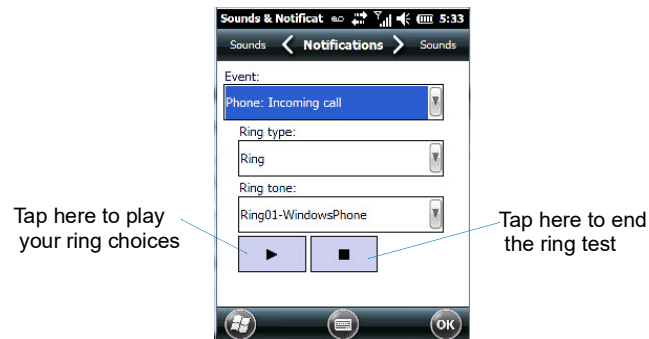

This tab allows you to choose an event, and for each event, choose the audio notification or sound that the Omnii will emit for that event. For example, suppose you choose Phone: Incoming call from the Event: drop-down menu. You can choose a specific Ring type for this event from the drop-down menu, perhaps Vibrate and ring. In the Ring tone drop-down menu, you can choose the tone or sound of the ring. If your Omnii vibrates and emits the ring you selected, you will immediately know your hand-held is receiving an incoming phone call.

- Choose an event from the **Events** drop-down menu.
- Choose the **Ring type** and **Ring tone** for the event you've chosen.
- To test your choice, tap on the arrow below **Ring tone**. The small square button stops the ring test.

Connections Folder

This folder icon contains the applets you'll need to set up connections using Bluetooth and an 802.11 radio.

- Tap on **Start>Settings>Connections folder** icon.



Beam

Enabling the Beam applet makes your Omnii visible and available to others wanting to beam information to your unit.

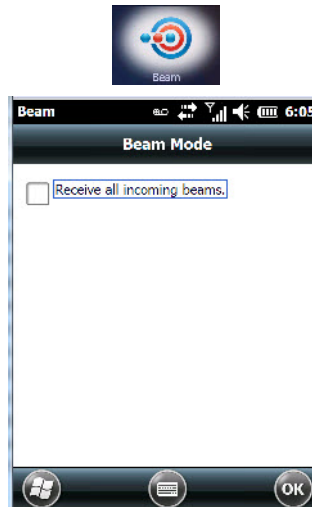

Bluetooth Setup

Bluetooth is a global standard for wireless connectivity for digital devices and is intended for Personal Area Networks. The technology is based on a short-range radio link that operates in the ISM band at 2.4 GHz. When two Bluetooth-equipped devices come within a 10 meter range of each other, they can establish a connection. Because Bluetooth utilizes a radio-based link, it does not require a line-of-sight connection in order to communicate.

- Tap on **Start>Settings**. Tap on the **Connections Folder** icon followed by the Bluetooth icon.

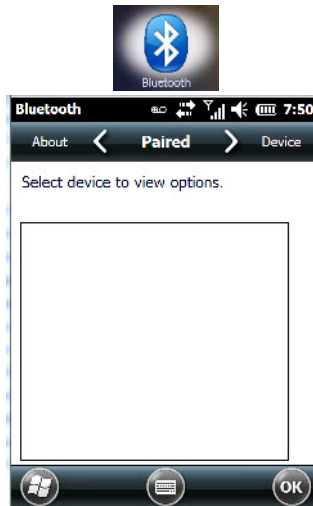

Turning the Bluetooth Radio On

Before pairing a headset or any other Bluetooth device with your Omnii, make certain that the Bluetooth device power is enabled and that the radio is switched on; it is enabled by default. If, for some reason, it has been disabled:

- Scroll to the **Mode** tab.
- Tap in the checkbox next to **Turn on Bluetooth**.
- Turn your Bluetooth device on and place it within a few feet of your Omnii.
- If needed, set your Bluetooth device to visible (discoverable) so that the hand-held can detect it and establish a connection.

The Devices Tab - Scanning for Bluetooth Devices

- Scroll to the **Device** tab.



- To discover and list all Bluetooth devices in range of the Omnii, tap on the **Scan** button in the softkey bar at the bottom of the screen.

The Omnii scans for Bluetooth devices within a 10 meter range. Any Bluetooth devices within range appear in the Bluetooth list box. Any existing devices previously discovered and listed will also be displayed.

NOTE To limit the scope of the scan to a particular type of device, refer to ‘Filtering by Class of Device (COD)’ in the next section.

The Clear button removes all Bluetooth devices listed except those with currently paired and connected services.

Device Pop-up Menu

The Device pop-up menu allows you to pair a device, update a device name or delete a device from the list.

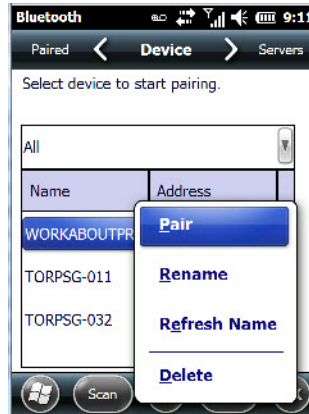

Pair begins the pairing process by querying the services and profiles of the discovered device. An authentication dialog box is displayed the first time a Bluetooth device is paired.

Rename allows a new name to be assigned to a highlighted device.

Refresh Name repeats the device name query, updating the name. This command is useful if a device is listed without a name (unknown), or if a device name has been changed remotely.

Delete removes this device from the list.

Filtering by Class of Device (COD)

The drop-down menu at the top of the Device tab allows you to limit the scope of the scan to a particular type of device. If, for example, you choose Computer from this menu, only computers within range of the Omnii are listed in the Device tab. Choosing All lists all detected devices.

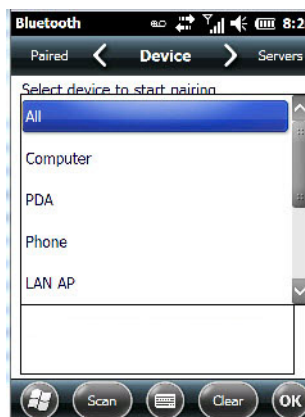

Pairing a Device

If you intend to pair a device (a headset, for example), power the device on and bring it within 10 meters of the Omnii before proceeding with the discovery process described below.

To pair devices:

- Follow the manufacturer's instructions to place the remote device in pairing mode.
- Choose the **Devices** tab and **Scan** for devices in your area.
- When the scan is complete, tap on the **device** to which you want to pair.
- In the pop-up menu, choose **Pair**.

An authentication dialog box is displayed.

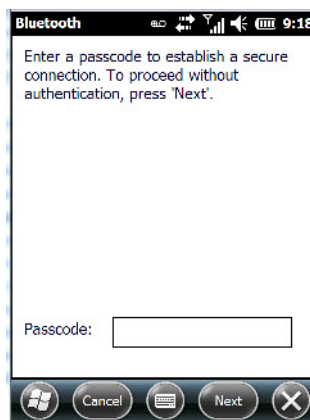

- If the remote device has authentication enabled, type the **PIN** in this dialog box.
- To proceed without authentication, tap on **Next**.



NOTE If a remote device has authentication enabled and you've skipped the authentication process, a pop-up screen will ask if you want to allow the remote device to connect to the Omnii. Tap on **Yes** and type the PIN. When authentication is complete, tap on **Done**.

After entering the device PIN, the Services dialog appears with a list of services available for that device.

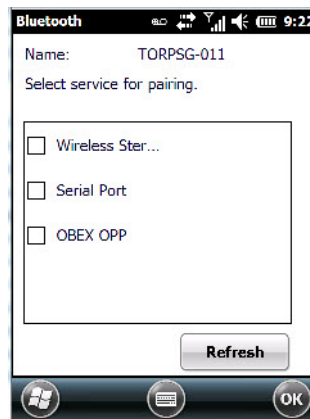

- Click in the checkbox to the left of the service to activate it.
- Click on **Done**.

i NOTE If you choose a service requiring additional information, a dialog box is automatically displayed where further details can be completed.

The sample dialog box below is an example of a service requiring additional information – in this case, the Serial Port Service.

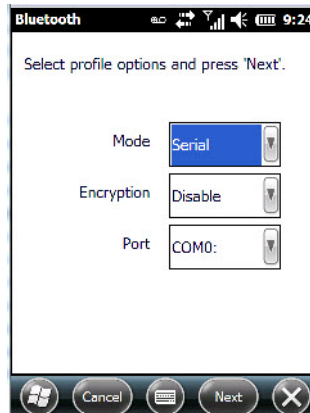

This dialog box offers a number of additional options such as enabling Encryption and selecting three different modes: Serial, ActiveSync and Scanner.

- Serial is used for simple serial port communication.
- ActiveSync is for ActiveSync-over-Bluetooth.
- Scanner is used to create a seamless connection between the incoming Bluetooth barcode and the Omnii.
- Printer Port is for connection to a printer over Bluetooth.

Once you've completed the information:

- Tap on **Next** and then in the Services screen, tap on **OK**.

Servers Tab

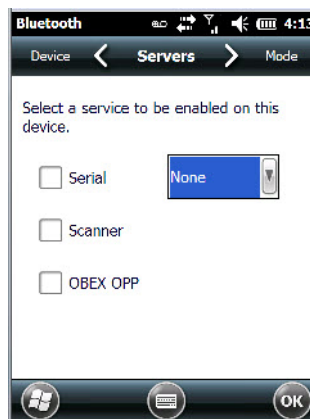

When a remote Bluetooth device initiates a Bluetooth connection to the Omnii, the remote device is considered the 'Bluetooth central' and the hand-held, the 'Bluetooth peripheral'. In order for the remote device to connect to the Omnii, the Omnii must offer a service in the form of a server. The Servers tab allows these services to be enabled and configured. There are three server services available: Serial, Scanner and OBEX OPP (Object Exchange-Object Push Profile).

Serial server enables the Serial Port Profile server; a Serial Port can be selected from the drop-down menu. Keep in mind that when a port is chosen, an application must be open (connected) to the chosen port for a remote device to be able to connect.

Scanner server enables a Serial Port Profile server and then relays it to the Scanner Service (SCS). This is used for Bluetooth barcode scanners that operate in client mode. SCS opens the server port and handles the scanner input.

OBEX OPP server enables the Object Push Profile server. A warm reset must be performed on the Omnii after a change is made to this option. The OPP Server allows other Bluetooth devices to send files to this device.

- Tap on the checkbox to activate the server – the associated port name is displayed beside the server name.

Mode Tab

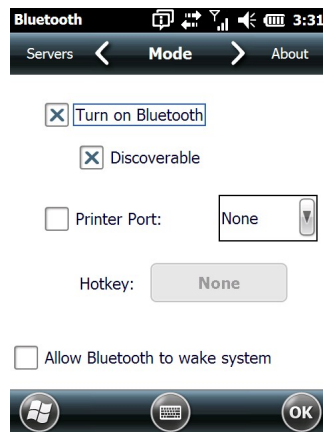

When Turn on Bluetooth is checked, Bluetooth features are available. If this option is disabled, you cannot send or receive information using Bluetooth.

When Discoverable is enabled, other Bluetooth devices within range (approximately 10 meters) can detect your Omnii and can establish a bond or use a Bluetooth service. Note that other devices can detect your unit whether or not a bond has been created.

If Allow Bluetooth to wake system is enabled, this feature allows remote Bluetooth devices to wake the Omnii by requesting a Bluetooth service that requires host intervention. This feature can also be used, when the Omnii is waking from suspend, to significantly to reduce the initialization time of Bluetooth system.

About Tab



Name displays the broadcasted name of the Omnii. The name can be changed in the About applet – tap on **Start>Settings>System>About** icon. Tap on the **Device ID** tab, and change the name.

Local Address displays the MAC address (BD_Addr) of the Bluetooth chip.

HCI Version & LMP Version display the version of the chip firmware.

Component indicates the version of the Zebra Bluetooth Subsystem (the manager, drivers, etc).

Profiles lists the supported profiles on this specific Omnii.

Paired Tab

This tab lists all paired devices and their corresponding services. The format of the name is <Device Name>:<Service Name>. Additional information may appear in this screen such as the Port Numbers for Serial Profiles service.



- Tap and hold down the stylus on an item in the Paired tab to display an associated pop-up menu.

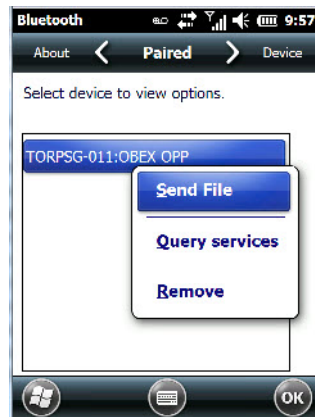

This is a service-dependent menu – that is, it varies slightly depending on the service chosen in the Servers tab.

Query Services and Remove Commands

i **NOTE** The Query Services and Remove commands are available in all service-dependent menus, regardless of the type of service chosen.

- Query Services displays a Services dialog box where a pairing service is chosen.
- Remove unpairs the highlighted service and deletes the entry from the tab.

OBEX OPP (Object Exchange-Object Push Profile) Commands

The OPP defines two roles – a Push Server and a Push Client. Push Server is the device that provides an object exchange server. Push Client is the device that pushes and pulls objects to and from the Push Server.

OBEX OPP contains the following unique menu option:

- Send File displays an Open File dialog box where the file to be sent can be selected. When the transmission begins, another dialog box tracks the progress of the file transmission.

HSP/HFP (Headset Profile/Hands-Free Profile) Service Commands

The HSP (Headset Profile) allows users to connect their device to Bluetooth enabled headsets and other audio devices.

HSP/HFP services provide the following unique menu options:

- Connect Audio establishes an audio connection to the Bluetooth headset.
- Disconnect Audio disconnects the audio connection from the Bluetooth headset.
- Volume Control displays a dialog box where the headset and microphone volume can be adjusted.

Connecting Using a Bluetooth GPRS Phone

Once you've completed the Bluetooth settings, you can go ahead and set up communication through your Bluetooth-equipped phone.

Before you begin, make certain that the Bluetooth phone is turned on, that the Bluetooth radios in your Omnia and phone are enabled (turned on), and that the hand-held and phone are within 10 metres of each other. Both should be discoverable.

1. Tap on **Start>Settings**, and then tap on the **Connections** folder icon.

2. Tap on the **Connections** icon. Under ISP: WWAN - GPRS, tap on **Add a new modem connection**.

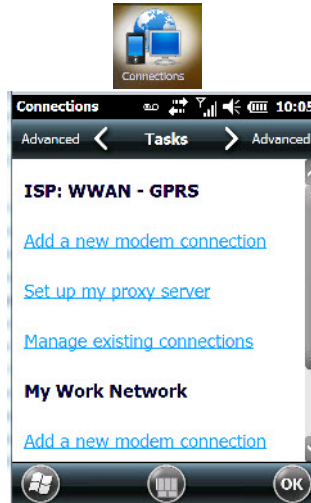

3. Type a name for the connection.

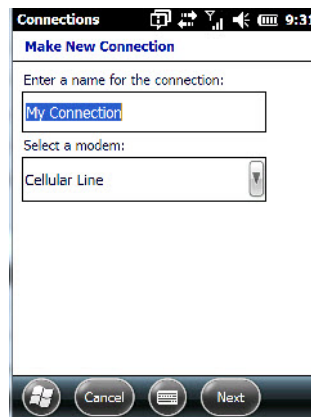

4. Tap on the **Select a modem** drop-down menu, and choose Bluetooth. Tap on **Next**.



NOTE If you are using another device to connect to the Internet, you can choose a different modem from the drop-down menu.

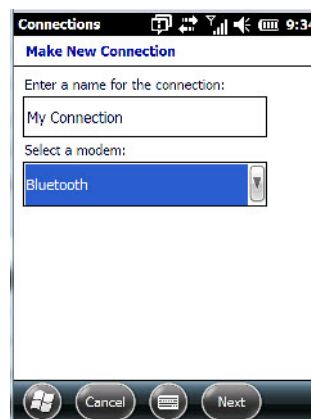

5. Make certain that the phone is discoverable. Some phones also need to be pairable in order to accept a bonding request. Refer to your phone documentation for additional information.

6. If the phone appears in the My Connections list, skip to step 13. If not, go to step 7.
7. In the list, tap the **phone** you want to connect to, and then tap on the **Next** button. (Note that if your phone is not listed, tap on Add new device, and choose the phone from the list.)
8. In the PIN screen, type a **personal identification number** (PIN) – you can enter up to 16 characters.
9. Enter the **same PIN** on the phone.
10. If you wish, you can edit the name of the phone in the Name field.
11. Tap on the **Finish** button.
12. In the My Connections list, tap on the **phone**, and then on **Next**.
13. Enter the **dial-up phone number** for this connection, and tap on **Next**.
14. In the User name, Password and Domain fields, enter the **logon information** for this connection, and tap on **Finish**.

You can begin using the Bluetooth phone connection, for example, to send and receive e-mail, browse the Internet with Internet Explorer, and so on.

Connections – Connecting to the Internet

To activate a connection, make certain that any necessary equipment (such as a radio) is installed in your Omnia.

You'll need the following information from your ISP to make an Internet connection:

- ISP server phone number,
- user name, and
- password.

You'll need to tap on **Start>Settings**, and then tap on the **Connections** folder icon to display the connections applets.

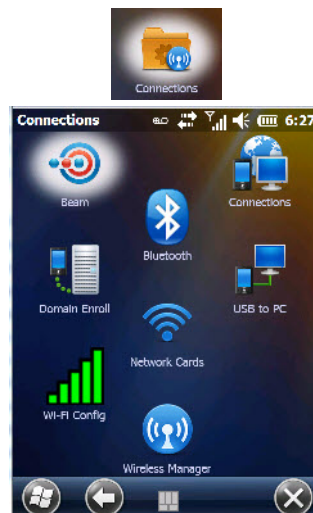

1. In the Connections screen, tap on the **Connections** icon.



NOTE In the Connections window, the Tasks tab is used to create new connections and manage existing ones. The Advanced tab allows you to choose a network. If you need to change these settings, contact your ISP or network administrator before making changes.

2. Under ISP: WWAN - GPRS, tap on **Add a new modem connection**.
3. In the **Select a modem** drop-down menu, choose a modem connection. If you haven't already created a modem connection, refer to "[Modem Connection Setup](#)" on page 4-24.
4. To connect to the Internet, launch the program you want to use. For example, launch Internet Explorer on your Omnii to browse the Internet. Your Omnii automatically connects.



NOTE To set up a network card or wireless network connection to your ISP, add a new connection under My Work Network.

Modem Connection Setup

Before you begin, you'll need the following information from your ISP or network administrator: telephone number, password, domain name, and TCP/IP settings.

If your Omnii does not have access to a mobile phone network, insert a modem card in the unit.

1. Tap **Start>Settings**. Tap on the **Connections** folder icon followed by the **Connections** icon.
2. To create a new connection in either ISP: WWAN - GPRS or My Work Network, tap on **Add a new modem connection**.

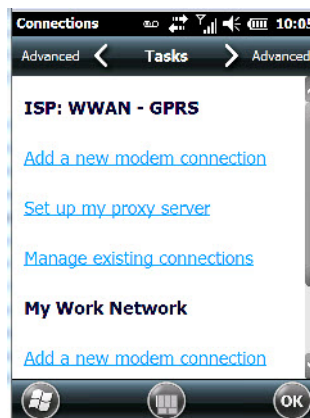

3. In the Make New Connection screen, type a **name** for the connection.

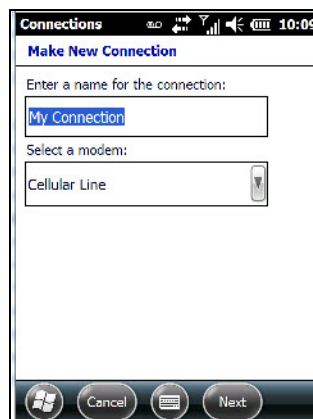

4. In the drop-down menu under Select a modem, tap on your **modem type**.



WARNING If your modem is not listed in the drop-down menu, choose Hayes Compatible on COM1.

- In the My Connections screen, enter the **phone number** exactly as you want it dialed. If, for example, you need to dial 9 for an outside line, enter 9 at the beginning of the phone number.

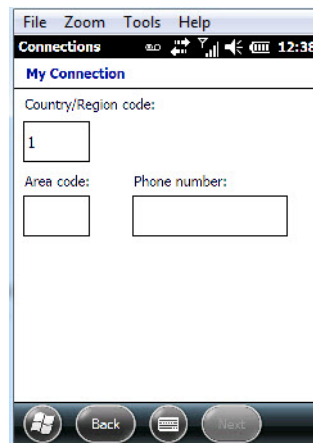

- Tap on the **Next** button.

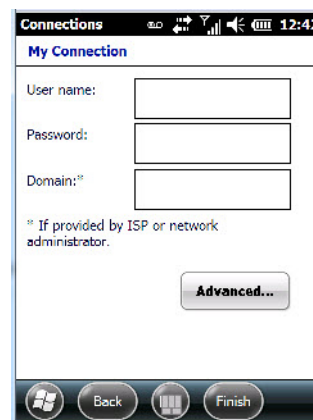

- Type the **User Name**, **Password** and **Domain Name** as provided by your ISP or network administrator.



NOTE Generally, you will not need to change any of the Advanced settings. For information about Advanced Modem Settings, review the next section.

Changes to Advanced settings are only required in the following instances:

- To change the baud rate settings, dialing string commands or credit card options.
- To change port settings.
- To enter TCP/IP settings because the server to which you are connecting does not dynamically assign addresses.

- Tap on the **Finish** button.

Advanced Modem Settings

TCP/IP Settings Tab

If your server assigns IP addresses dynamically, you will not need to change these settings. If you need to make changes, contact your ISP or network administrator for addresses.

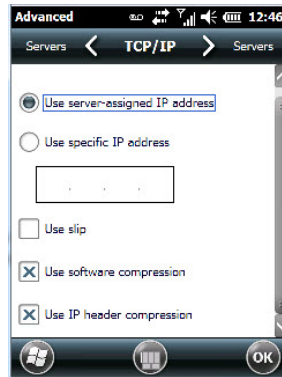

Server Settings Tab

If your server assigns IP addresses dynamically, you will not need to change these settings.

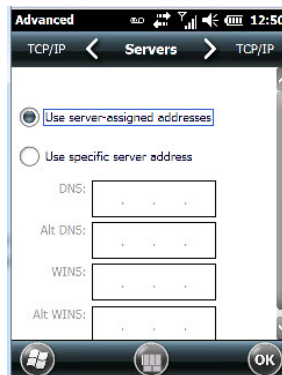

Servers requiring assigned IP addresses may also need a way to map computer names to IP addresses. The Omnii supports a variety of name resolution options: DNS, Alt DNS, WINS and Alt WINS.

Your ISP or network administrator can determine which name resolution you need, and can also provide the server address. In addition, you will want to ask if alternate addresses are available. An alternate address may allow you to connect when the primary server is not available.

Domain Enroll

To protect sensitive company data, businesses use firewalls and proxy servers to limit access to company resources to company employees only. If you need to access information on your company server remotely, the Domain Enrollment utility allows you to sync your Omnii credentials with your company enrollment server, allowing you to access your work remotely.

- Tap on **Start>Settings>Connections>Domain Enroll**.

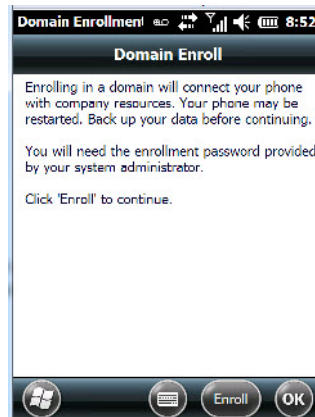

- Tap on the **Enroll** button.

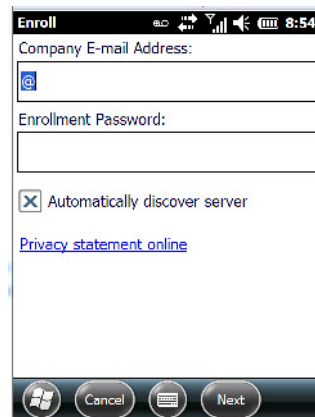

- Enter your **enrollment password** – supplied by your company's network administrator or generated from your company pre-enrollment wizard.
- Type your **company e-mail address** and the **enrollment password** provided by your network administrator.



NOTE If you uncheck **Automatically discover server**, a **Server** field is displayed where you must manually enter the server name.

Allow a few minutes for your Omnii to sync and enroll in your company domain. You may need to restart your unit after the enrollment process is completed.

Network Cards

When the network card is inserted in your unit for the first time, the Network Settings screen is displayed automatically so that you can configure the card. If it does not appear, or if you want to change settings:

- Tap on **Start>Settings>Connections**.
- Tap on the **Network Cards** icon.



- If you need to specify server information, double-tap on the appropriate **adaptor**, and then tap on the **IP Address** and/or **Name Servers** tab.

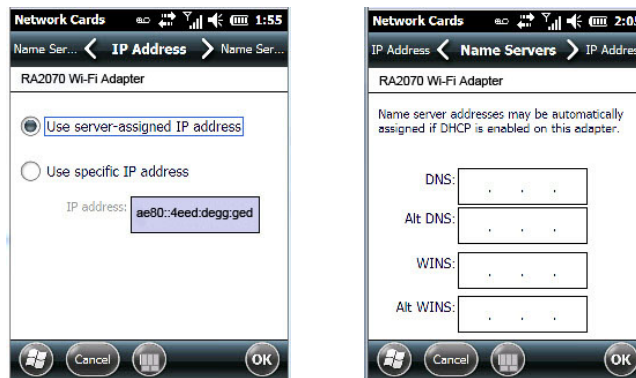

NOTE Because most networks use DHCP, you should not need to change these settings unless instructed to do so by your network administrator.

- If necessary, use a network cable to connect the network card to your network. Refer to the documentation shipped with your network card for details.
- To activate the connection, launch the desired program (e.g., Internet Explorer). The Omnii will connect automatically.

Changing Network Card Settings

- If you use your network card in two locations like work and home, you'll need to change the network to which the network card connects.
- Tap on **Start>Settings>Connections>Network Cards**.

- In the Configure Network Adapters dialog box, tap on the drop-down menu below My network card connects to, and choose either **The Internet** or **Work**.

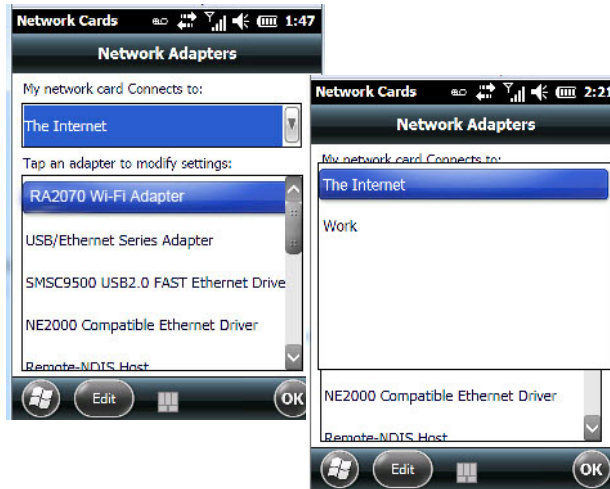

VPN Connection Setup

A VPN connection provides a secure connection to servers through the Internet.

Before you begin, you need the following information from your network administrator: password, domain name, TCP/IP settings and a host name or IP address of the VPN server.

- Tap on **Start>Settings**. Tap on the **Connections folder** icon followed by the **Connections** icon.

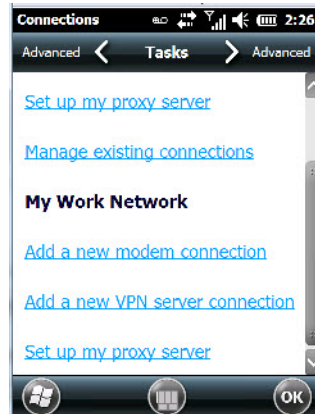

- Under My Work Network, tap on **Add a new VPN server connection**.



- In the Name field, type a **name** for this connection.
- In Host name/IP, type the **VPN server name** or **IP address**.
- Tap on the VPN type radio button next to the type of authentication for your Omnii: **IPSec/L2TP** or **PPTP**. Your network administrator will let you know which option applies to your unit.
- Tap on **Next**.
- Choose the type of authentication in this screen. If you choose A pre-shared key, type the key provided by your network administrator.
- Tap on **Next**.
- Type your **user name**, **password** and **domain name**. If a domain name was not provided to you, try the connection without entering a domain name.



NOTE Normally, you will not need to change any advanced settings. You will need to make changes only under only the following circumstances:

- The server to which you are connecting does not dynamically assign addresses, and TCP/IP settings need to be entered.
- Server DNS or WINS settings need to be changed.

If you need to edit the Advanced settings, refer to “[Advanced Modem Settings](#)” on page 4-25 for details about this tab.

- Tap on **Finish**.
- Launch a program like Internet Explorer to activate the connection. The VPN connection will start automatically.

Managing an Existing Connection

Once you've defined a connection, a new option appears in the first Connections screen – Manage existing connections.

Editing a Connection

- Tap on **Start>Settings>Connections folder** icon. Tap on the **Connections** icon.
- Tap on **Manage existing connections**.

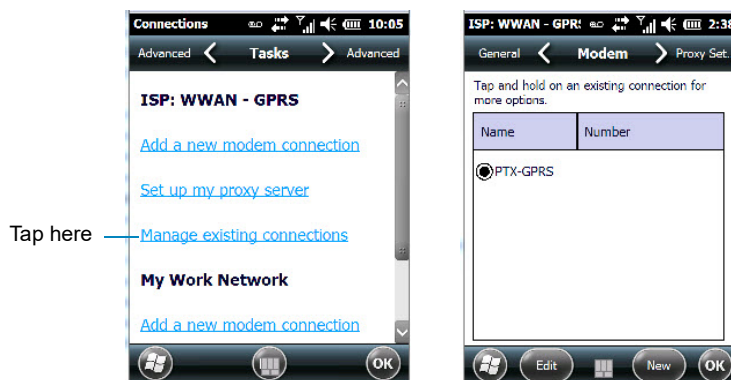

- To launch a connection from this screen, press and hold the stylus on the connection you want to activate. Choose **Connect** from the pop-up menu.
- To delete a connection, press and hold the stylus on the connection you want to delete. Choose **Delete** from the pop-up menu.

- NOTE** You can also create a new connection by tapping on the New button. To make changes to the settings for this connection, tap on Edit.

Changing a Connection Setting Name

Your Omnii has two sets of connection settings: My ISP and My Work Network. If you want to change one or both of these options to something more familiar to you, follow these steps.

- Tap on **Start>Settings**. Tap on the **Connections folder** icon followed by the **Connections** icon.
- Under My Work Network or My ISP, tap on **Manage existing connections**.
- Tap on the **General** tab.



- Type the name you prefer in the field below Enter a name for these settings.
- Tap on **OK**.

Proxy Server Tab

- NOTE** If you are connected to your ISP or private network during synchronization, the Omnii will download the appropriate settings during synchronization from your PC. If these settings are not on your PC, or if they need to be changed, you'll need to set up the proxy server connection manually.

To set up the proxy server connection manually, you'll need the following information: proxy server name, server type, port, type of Socks protocol used, and the user name and password.

- Tap **Start>Settings**. Tap on the **Connections** tab followed by the **Connections** icon.
- Under My Work Network, tap on **Set up my proxy server**.

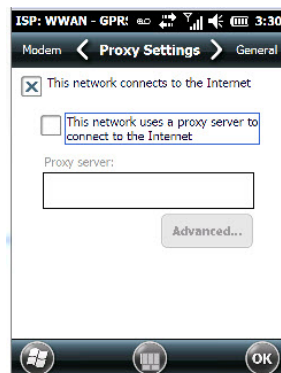

- Tap in the checkbox next to **This network connects to the Internet** and **This network uses a proxy server to connect to the Internet**.
- In the Proxy server field, type the **proxy server name**.
- Tap on **OK** to save your changes.



NOTE If you need to change advanced settings such as a port number or proxy server type, you'll need to tap on the **Advanced** button rather than tapping on **OK**. Advanced settings are described in “Changing Advanced Proxy Server Settings” in the next section.

Changing Advanced Proxy Server Settings

- To change advanced settings such as the port number or proxy server type, tap on the **Advanced** button.

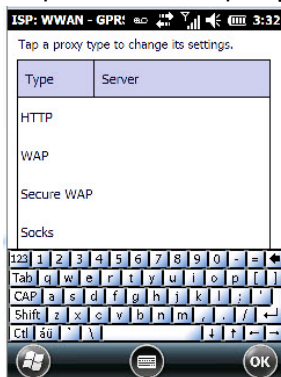

- Tap on the proxy type you want to change. For the appropriate server type, type the proxy server name and port.
- Tap on **OK**.

Selecting a Network



NOTE Normally, you will not need to change these settings. Contact your ISP or network administrator before making any changes.

Private networks are used for work-related activities. Internet networks are used for home connection to your ISP. The My Work Network settings are used for private network connections (corporate networks), while My ISP settings are used for Internet network connections.

When you use programs such as Internet Explorer, your Omnii automatically connects using private network settings under My Work Network or Internet settings under My ISP, depending on specifications. You can determine how your Omnii connects.

- Tap **Start>Settings>Connections folder** icon.



- Tap on the **Connections** icon, and then tap on the **Advanced** tab.

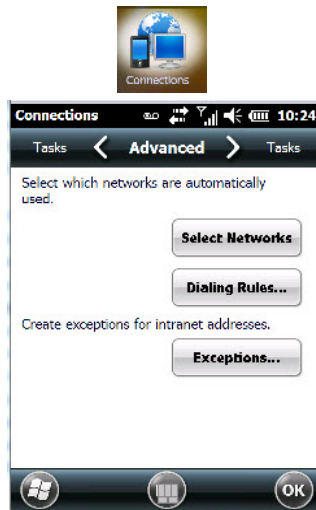

- Tap on **Select Networks**.
- In the appropriate list, choose **My ISP** or **My Work Network**.

Wi-Fi Config - Setting Up the 802.11a/b/g/n Radio

Omnii contains an integrated 802.11a/b/g/n radio module. The Wi-Fi Config application is used to configure the radio for one or more wireless network profiles. Follow the steps in this section to help configure the radio in your unit.

NOTE To configure your **Bluetooth** settings, go to **“Bluetooth Setup”** on page 4-14.

To see specifications for this radio, refer to [Appendix E: “Omnii Specifications”](#).

A network profile contains settings for SSID (Service Set Identifier) and security options.

NOTE In most situations, the configuration of your 802.11 radio will require parameter settings and access keys from a network administrator.

To launch the Wi-Fi Config application:

- Tap on **Start>Settings>Connections folder** icon.
- Tap on the **Wi-Fi Config** icon.



The Wi-Fi screen is displayed:

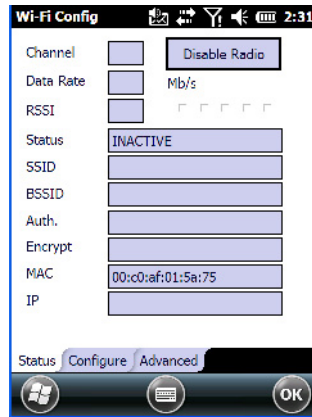

Wi-Fi Config: Status Tab

The Status tab displays information about the wireless network to which Omnii is configured to connect. When there are no network profiles configured, this tab is not populated.

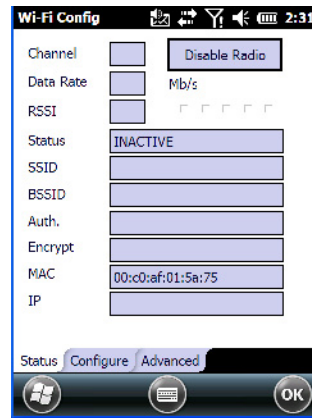

Disable/Enable Radio: This button toggles between Disable Radio and Enable Radio depending on whether the radio is turned off or on.

Wi-Fi Config: Configure Tab



NOTE If the Configure tab is not visible, open the Advanced tab, uncheck 'Use Windows to configure my wireless settings', and reset the Omnii.

- To configure the radio for a wireless network, tap on the **Configure** tab.

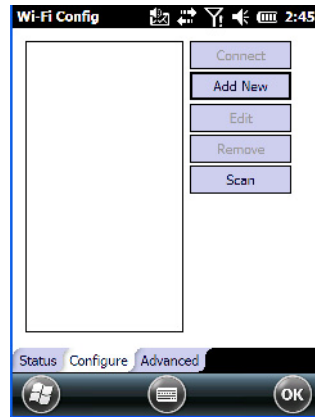

Connect: Used to connect to an already existing wireless network configuration.

Add New: Used to create a new wireless network configuration.

Edit: Used to change values in an existing wireless network configuration.

Remove: Used to delete a wireless network configuration.

Scan: Used to detect and list available wireless networks. You can highlight a network in the list, and tap on Add New to activate the network.

There are two methods available when configuring a radio network – you can either scan for an existing network or manually create a network. If you tap on the **Scan** button, a list of networks detected by the radio is displayed. Highlighting one of the listed networks and tapping on the Add New button creates a new profile that is completed based on the security capabilities detected by the radio. You may need to add additional information, depending on your network requirements.

If you tap on the **Add New** button rather than the Scan button, you can create a network manually.



IMPORTANT

The steps below describe how to manually create a network. Keep in mind that this is intended only as an example and may vary from your own network requirements. If, for example, you are using a different type of security for your network, the fields you complete may not match those described here.

Manually Creating a Network

- In the Configure tab, tap on the **Add New** button.
- Enter the **SSID** (Service Set Identifier) for your network.

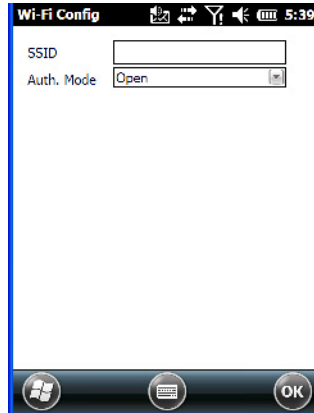

Authentication Mode

Omnii supports several classes of authentication – Open, WEP, WPA/WPA2 (Personal PSK, Enterprise, CCKM-WPA, CCKM-WPA2), and 802.1x with EAP. Tapping on the Auth. Mode menu displays your authentication options.

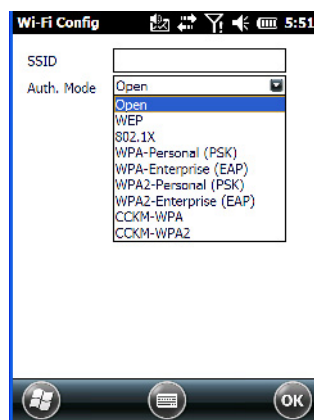

NOTE Each Auth. Mode has a unique Configure Profile screen attached to it with fields appropriate to the authorization mode you've chosen.

Open Authentication

Open authentication does not provide security. When this option is chosen, Omnii will connect to wireless networks which do not use authentication or encryption.

WEP (Wired Equivalent Privacy)

WEP provides static security to prevent others from accidentally accessing your network. If you choose this option, you can specify the type of WEP authentication – Open or Shared, the WEP security key length – 64 bit or 128 bit and the key type – ASCII or Hex. WEP Key fields are also provided where you can specify a 5 or 13 ASCII character sequence or an equivalent 10 or 26 Hexadecimal digit sequence that matches the active WEP key on the access point.

802.1X, WPA & WPA2 Enterprise, CCKM-WPA & CCKM-WPA2

These authentication modes use 802.1X with EAP authentication. When 802.1X is selected, Omnii uses WEP encryption with automatic (as opposed to static) keying. For the others, you may choose TKIP, AES or TKIP+AES encryption.

WPA & WPA2 Personal PSK (Pre-Shared Key)

When PSK is selected, either WPA Personal PSK or WPA2 Personal PSK — a shared key must be configured on both the access point and the hand-held computer. One of the following can be chosen from the Encryption drop-down menu: TKIP, AES or TKIP+AES.

Encryption

The Encryption menu allows you to choose the type of encryption that will be used to protect transmitted data. Choose an Encryption method valid for your network from the drop-down menu. Only the Encryption options that are compatible with the type of Auth. Mode you've chosen will be listed. In fact, in some cases, this menu will not be available at all.

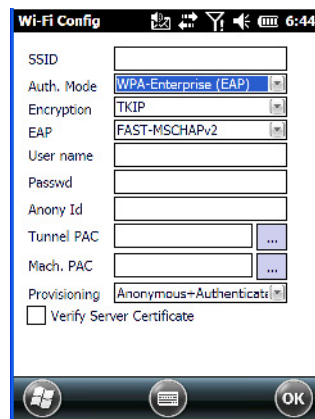

EAP

This menu allows you to choose the EAP (Extensible Authentication Protocol) type used for 802.1x authentication to an access point.

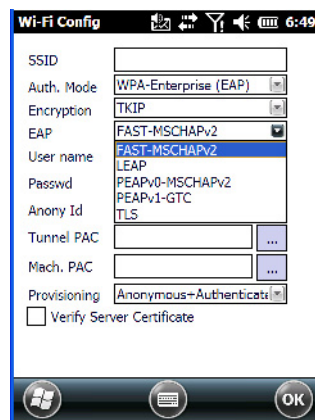

The following EAP types are supported by Wi-Fi Config:

- **FAST-MSCHAPv2:** Is a successor to LEAP and does not require strong passwords to protect against off-line dictionary attacks. Like LEAP, EAP-FAST does not require the use of server or client certificates and supports Windows Active Directory and domains.
- **LEAP:** Is an authentication method for use with Cisco WLAN access points. LEAP does not require the use of server or client certificates. LEAP supports Windows Active Directory and domains but requires the use of strong passwords to avoid vulnerability to off-line dictionary attacks.

- **PEAPv0-MSCHAPv2:** Provides secure user authentication by using a TLS tunnel to encrypt EAP traffic. MSCHAPv2 is used as the inner authentication method. This is appropriate for use against Windows Active Directory and domains.
- **PEAPv1-GTC:** PEAP authentication using GTC as the inner method which utilizes one time passwords (OTPs) for authentication against OTP databases such as SecureID.
- **TLS:** Provides strong security via the use of client certificates for user authentication.

Verify Server Certificate

When the Verify Server Certificate box is checked, the Omnii will verify the certificate provided by the authentication server during the authentication process. This requires that an appropriate certificate be manually installed on Omnii for the verification.

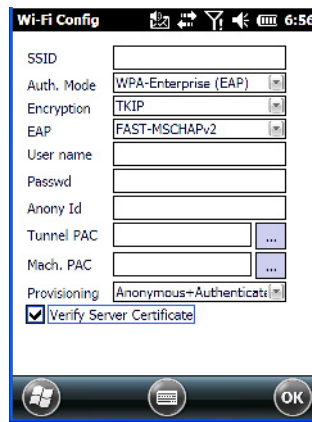

Enable OPMK

When used with compatible wireless infrastructure, Opportunistic Key Caching (OPMK) reduces the number of full authentications required when roaming. This option is only visible when WPA2-Enterprise (EAP) authentication mode is chosen.

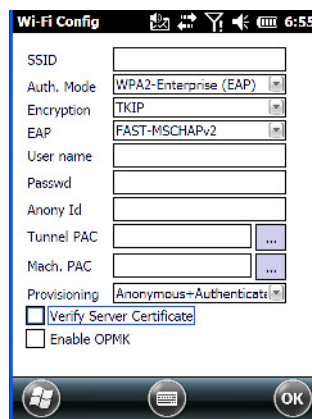

Connecting the Wireless Network

Your configured network is listed in the Configure tab. An [X] next to a network indicates that this is the network to which Omnii will connect.

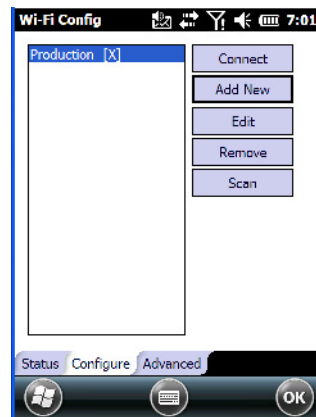

- Tap on the **Connect** button to activate your network.

The Status tab is displayed. The Status field displays ASSOCIATING while the 802.11a/b/g/n radio attempts to connect to the network. Once the association is complete, the Status tab is populated with the appropriate information about your network.

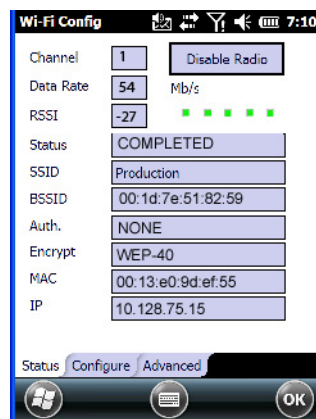

Configuring TCP/IP

If your network is not using a DHCP server, you will need to assign an IP address.

IP Address and Name Servers

To assign an IP Address for the Omnii:

- Tap on **Start>Settings>Connections** folder icon>**Wireless Manager** icon.
- Tap on the **Menu** button, and choose **Wi-Fi Settings**.

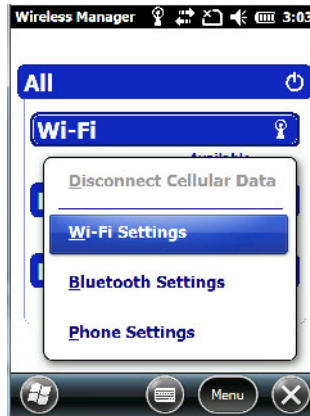

- In the Wi-Fi screen, use the scroll bar at the top of the screen to scroll to the **Network Adapters** tab.

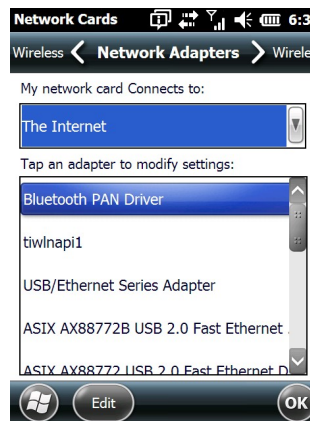

- Tap on **tiwnapi1**.



The IP Address screen offers two options: a server-assigned IP address or a user-assigned IP address.

If you want an address assigned automatically:

- Tap on **Use server-assigned IP address** to have an address assigned automatically, or

If you want to define your own IP address:

- Tap on **Use specific IP address**.
- Type the preferred IP address, Subnet mask and Default gateway.

Name Servers

If you tap on the Name Servers tab at the top of the screen, you can statically configure the DNS servers; however, if you use DHCP for IP address assignment, DNS is usually supplied by the same server that supplied the IP addresses.

Wi-Fi Config: Advanced Tab

This screen provides a number of options which are described in this section.

Country Options



IMPORTANT

802.11d is enabled by default for auto-country detection. If you are having difficulty associating with your access point, you may need to disable 802.11d and choose your country.

In the Wi-Fi Config>Advanced tab, choose **Country Option**. In the drop-down menu, choose your **country**.

Wireless Zero Config

If you prefer to use Wireless Zero Config, the Windows native supplicant, to configure the radio:

- Tap on the **Advanced** tab, and tap on the **checkbox** to the left of Use Windows to configure my wireless settings to add a check mark and activate this option.

Tap here to add a check mark to activate Windows radio configuration.

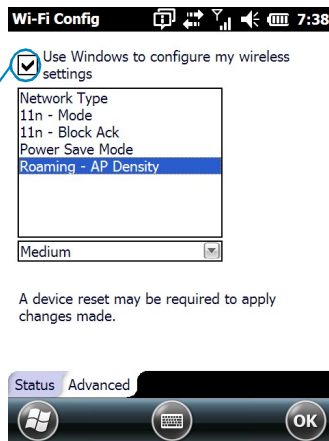

Network Type

This option allows you to select the full set or a sub-set of the IEEE 802.11 wireless network protocols. You can choose from the following:

- **b only:** forces the radio to operate in the 2.4GHz band only. The hand-held will only associate with an Access Point (AP) that supports the DSSS data rates 1, 2, 5.5 & 11 Mbps. This mode has the lowest data rate but yields the longest range.
- **b/g only:** forces the radio to operate in the 2.4 GHz band only. The Omnia will only associate with an AP that supports the DSSS data rates 1, 2, 5.5 & 11 Mbps and OFDM data rates: 6, 9, 12, 18, 24, 36, 48, 54Mbps. This mode offers the same range as b only mode but with higher data rate of 54 Mbps when possible
- **a only:** forces the radio to operate in the 5 GHz band only. The hand-held will only associate with an AP that supports the OFDM data rates: 6, 9, 12, 18, 24, 36, 48, 54 Mbps.

11n Mode

This radio supports MIMO data rates in both 2.4 GHz and 5 G band (although it only supports single stream operation (SISO)). This increases the maximum data rate to 65 Mbps.

- **Enabled:** If this option is enabled, it is activated for the band or bands that were selected in Network type. For example, if Network Type = b only, 11n is only switched on for the 2.4GHz band.

11n – Block Ack

When **11n – Block Ack** is enabled, the Omnii will not send an ACK for every packet received, but it will send an ACK after a block of data is received. The duration of time before sending an ACK is negotiated with the AP.

Power Save Mode

If **Power Save Mode** is enabled, the radio remains on continuously. The disadvantage to enabling this option is increased power consumption. The advantage to enabling this option is instant response to TCP/IP traffic.

It is recommended that Power Save Mode be enabled to increase battery run time. It should only be disabled if the application is sensitive to timing.

Roaming - AP Density

The Roaming - AP Density setting controls how aggressively the Omnii attempts to roam. The available options are High, Medium, and Low with High providing the most aggressive roaming and Low providing the least aggressive roaming.

Wireless Manager

The Wireless Manager icon acts as a connection manager, providing access to all network connection types.

- Tap on **Start>Settings>Connections folder** icon. Tap on the **Wireless Manager** icon.

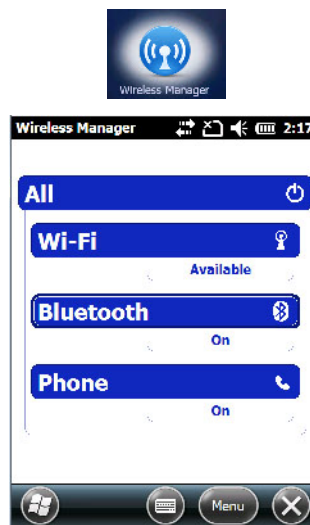

This screen is used to switch the wireless network connection on and off. This screen also provides access to the setup screens for each wireless connection.

- To turn connections on and off, tap on the item(s) in the list.
- To turn off all wireless connections, tap on **All**.

The Menu softkey at the bottom of the screen provides a shortcut to the setup screens for each of the options listed in the Wireless Manager screen.

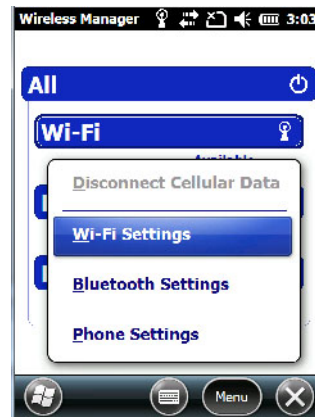

Personal Folder

- Tap on **Start>Settings>Personal** icon.

App Launch Keys

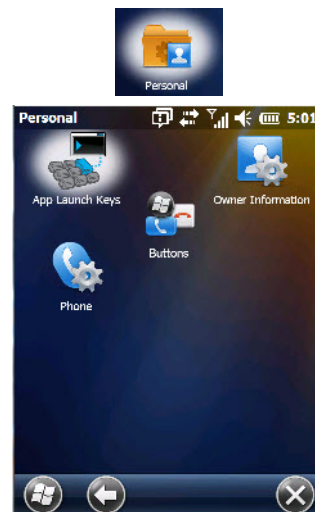

This icon allows you to map a key to an application so that you can then launch the application from a single key-press.

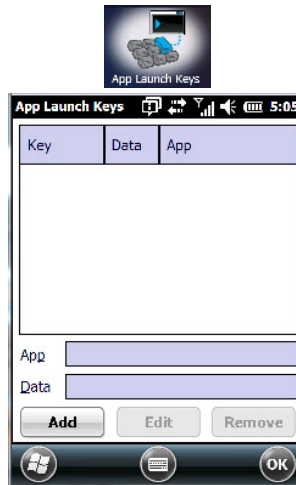

To assign an application key:

- Tap the **Add** button.

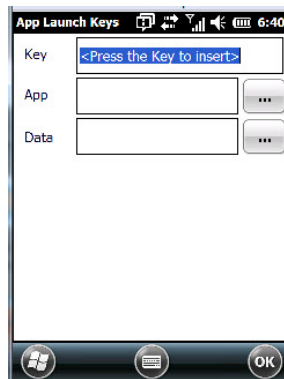

- Press the key you want to use to launch an application. (If an unsupported key is pressed, a message appears on this screen letting you know.)

The cursor moves to the App field and a new screen is displayed where you can choose the application to which you want to assign the application key. If you need to, you can Browse through the information in your hand-held until you locate the application you want to launch.

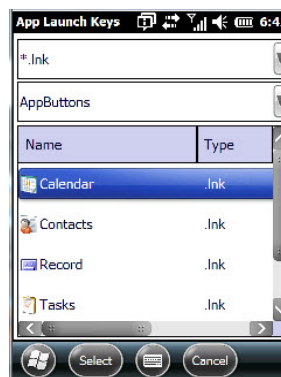

- Once you've selected the file you want to map, tap on **OK**.

The cursor moves to the Data field. You can use this field if you need to assign special parameters to your application launch key. If you don't want to assign any parameters, you can leave the Data field blank. If, for

example, you want to assign an application launch key to launch the Word Mobile application, you can leave this field blank. If you want to assign an application launch key that will open a specific document in the Word Mobile application, you need to browse to and choose that document while the cursor is in the Data field.

- Tap on **OK**.

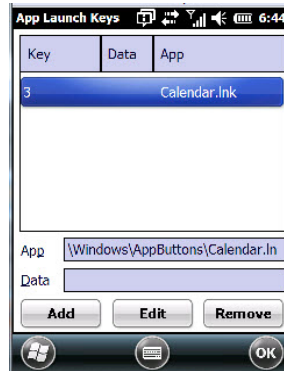

- If you need to Edit, Remove or Add another App Launch Key, you can do it from this final screen. Otherwise, tap on **OK** to save your Application Launch Key.
- To launch the application you chose, press the application key you assigned.

Buttons

A number of apps are included under this icon.

- Tap on the **Start>Settings>Personal>Buttons** icon to display the apps.

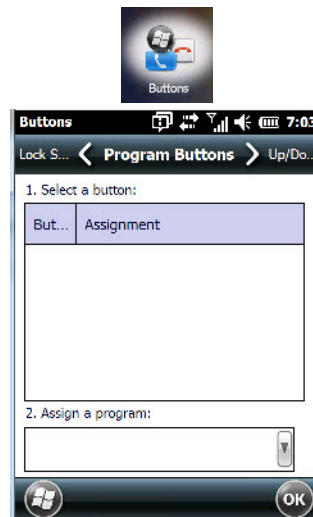

Program Buttons Tab

In the Program Buttons tab, you can customize the program hardware buttons to open your most used programs.

- Under Select a button, tap on the **button** to which you want to assign a program.
- Choose a program from the **Assign** drop-down menu.

Up/Down Control Tab

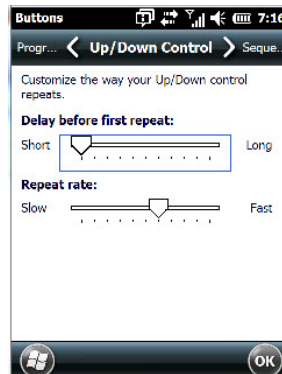

- Tap on **Start>Settings>Personal>Buttons** icon to display this screen. Scroll to the **Up/Down Control** tab.

Sliding the Delay before first repeat bar to the left decreases the delay between key repeats while sliding the bar to the right increases the repeat delay time.

Sliding the Repeat rate bar to the left slows the rate at which an [Up/Down] button repeats when pressed. Sliding the bar to the right increases the key repeat rate.

OneShots

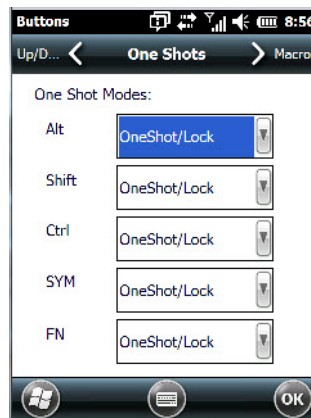

The options in this tab allow you to determine how modifier keys on your Omnii behave. For each modifier key – [ALT], [SHIFT], [CTRL], [SYM] and [BLUE/FN] – you have the following options in the drop-down menu: Lock, OneShot, and OneShot/Lock.



IMPORTANT

Once you've assigned a OneShot mode to a modifier key, you need to tap on the OK button at the top of the tab to activate your selection.

Lock

If you choose Lock from the drop-down menu, pressing a modifier key once locks it 'on' until you press the modifier key a second time to unlock or turn it off.

OneShot

If you choose OneShot, the modifier key remains active only until the next key is pressed.

OneShot/Lock

OneShot/Lock allows you to combine these functions. When you choose this option and you press the modifier key once, it remains active only until the next key is pressed.

If you press the modifier key twice, it is locked 'on', remaining active until the modifier key is pressed a third time to turn it 'off'.

Macro Keys

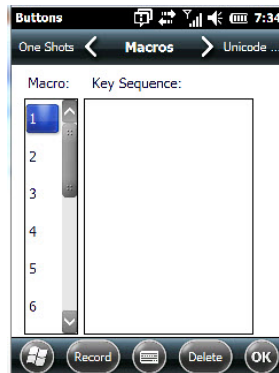

A macro key is a single keypress that can be configured to output up to 200 characters (including [ENTER], [BACKSPACE], [DEL], function keys, arrow keys, etc.). This feature can save time and effort when entering frequently used key sequences. For example, a macro key can be programmed to output a standard signature, such as “Sincerely yours,[ENTER]Bob” with a single keypress.

For all keyboard types, you can program up to 15 macro keys. Some Omnii keyboards have macro keys ([M1], [M2] and so on) that are physically present on the keyboard. When you record a macro sequence and assign it to one of these predetermined macro keys, pressing that key (e.g., [M1]) executes the macro and sends the programmed key sequence to the hand-held as if it were entered from the keyboard.

If your keyboard does not have dedicated macro keys, or if you wish to use macro keys beyond the ones that are already present on the keyboard, you need to use Scancode Remapping to remap keyboard keys to act as macro keys (see [“Scancode Remapping” on page 4-49](#)). For example, if you record a key sequence to Macro 7, you could then use Scancode Remapping to remap the [z] key so that pressing it executes Macro 7 rather than the letter [z].

Recording and Saving a Macro

- In the Macro menu, highlight a Macro number. Tap on the **Record** button.

A Record Macro screen is displayed.

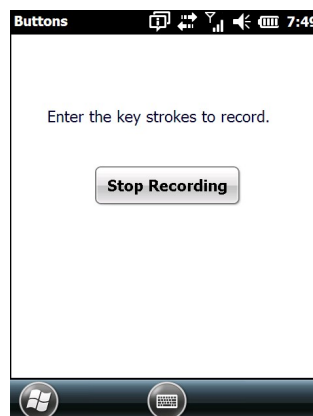

- Type the **macro sequence** you want to assign to a keyboard key. You can type text and numbers, and you can program the function of special keys into a macro.
- When you've finished recording your macro sequence, tap on the **Stop Recording** button.

A new screen displays the macro sequence you created.

- Tap on the **Save** button to save your macro. Your macro key sequence is listed in the Macro screen.
- Tap on **OK** to save your macro key assignment.

Executing a Macro

- To execute a macro, press the key to which you've assigned the macro.



NOTE Keep in mind that if you plan to program additional macros beyond the Macro keys on your keyboard, or if your keyboard is not equipped with dedicated macro keys, you will need to use [“Scancode Remapping” on page 4-49](#) to assign a keyboard key that will act as a macro key.

Deleting a Macro

- In the Macros tab, highlight the macro number you want to delete.
- Tap on the **Delete** button.

Unicode Mapping

- Tap on the **Unicode Mapping** tab to display this screen.

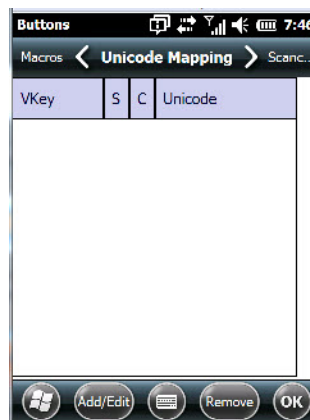

The Unicode Mapping tab is used to map combinations of virtual key values and [CTRL] and [SHIFT] states to Unicode™ values. This tab shows the configured Unicode character along with the Unicode value. For example, “a (U+0061)” indicates that the character “a” is represented by the Unicode value “0061”, and so on. Keep in mind that Unicode configurations are represented as hexadecimal rather than decimal values.

All user-defined Unicode mappings are listed in the Unicode Mapping tab in order of virtual key value, and then by order of the shift state. If a Unicode mapping is not listed, the Unicode mapping is mapped to the default Unicode value.

Adding and Changing Unicode Values



NOTE Changes to Unicode mappings are not saved until you exit the Unicode Mapping tab by tapping on [OK].

- Tap on the **Add/Edit** button.

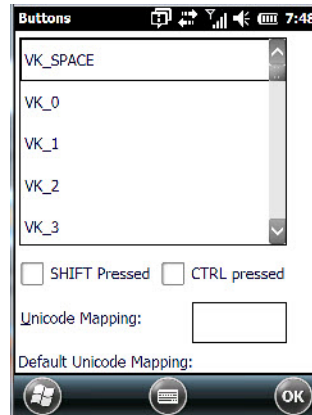

- Highlight a value in the Unicode mapping list.
- Position the cursor in the Unicode Mapping field, and type a **Unicode value** for the highlighted key.



NOTE To add a shifted state – [SHIFT] and/or [CTRL], tap on the checkbox next to 'SHIFT Pressed' and/or 'CTRL Pressed'.

Removing Unicode Values

- In the Unicode Mapping tab, highlight the item you want to delete, and tap on the **Remove** button.

Scancode Remapping

A scancode is a number that is associated with a physical key on a keyboard. Every key has a unique scancode that is mapped to a virtual key, a function, or a macro. Scancode Remapping allows you to change the functionality of any key on the keyboard. A key can be remapped to send a virtual key (e.g. VK_F represents the 'F' key; VK_RETURN represents the [ENTER] key, etc.), perform a function (e.g. turn the scanner on, change volume/contrast, etc.) or run a macro.

There are three different tables of scancode mappings: the Normal table, the FN table and the SYM table. The Normal table defines unmodified key presses; the FN table defines key presses that occur when the [FN/BLUE] modifier is on; the SYM table defines key presses that occur when the [SYM] modifier is on. The default mappings of these scancodes can be overwritten for each of these three tables using Scancode Remapping.

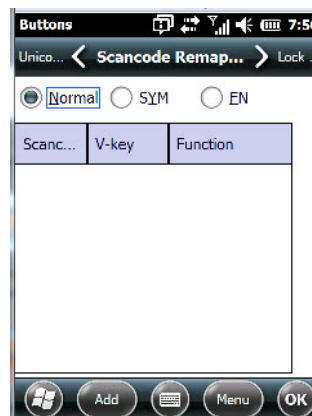

The first column in the Scancode Remapping tab displays the scancodes in hexadecimal. If the scancode is remapped to a virtual key, that virtual key is displayed in the column labelled V-Key. In the column labelled Function, virtual keys that are 'Shifted' or 'Unshifted' are displayed.

If the scancode is remapped to a function or a macro, the first and second columns remain blank while the third column contains the function name or macro key number (e.g., Macro 2).

Adding a Remap

To add a new remapping:

- Tap the **Add** button at the bottom of the dialog box.

The Remap Scancode dialog box is displayed.

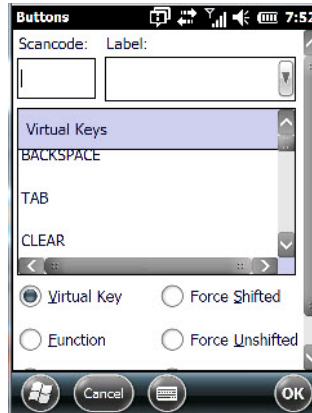

- Type the scancode in hexadecimal in the field labelled **Scancode**.



NOTE The Label field displays the default function of the scancode you are remapping.

Virtual Key, Function and Macro

The radio buttons at the bottom of the dialog box allow you to define to what the scancode will be remapped to: Virtual Key, Function or Macro.

When Virtual Key is selected, you can choose to force [SHIFT] to be on or off when the virtual key is sent. If No Force is selected, the shift state is dependent on whether the shift state is on or off at the time the virtual key is sent.

When Function is selected, a list of valid functions appears in the dialog box.

When Macro is selected, the macro keys available on your unit are listed in the dialog box.

- Choose **Virtual Key**>**Function** or **Macro**.
- Choose a function from the Function list, and tap on **OK**.

Editing a Scancode Remap

- In the Scancode Remapping tab, tap on the remap you want to edit.
- Tap on the **Edit** button, and make the appropriate changes.
- Tap on **OK** to save your changes.

Removing a Remap

- In the Scancode Remapping tab, highlight the scancode you want to delete, and tap on the **Menu** button, and choose **Remove**.
- Tap on **OK**.

Lock Sequence Tab

The Lock Sequence tab allows you to lock the hand-held keyboard to prevent keys from being pressed accidentally when, for example, the unit is inserted in a holster.

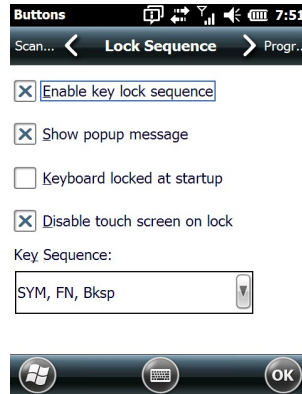

- To lock the keyboard, tap in the checkbox next to Enable key lock sequence.
- Tap in the checkbox next to Keyboard locked at startup.
- In the Key sequence drop-down menu, choose the key sequence you need to type to unlock the keyboard.
- Reset the Omnii – press and hold down the **[BLUE/FN]** key and the **Power** button.



NOTE It is useful to leave the Show popup message enabled (default) so that anyone attempting to use the Omnii keyboard will see the key sequence they will need to enter to unlock the keyboard displayed on the screen.

A locked keyboard icon is displayed in the softkey bar when the keyboard is locked.



- Type the key sequence to unlock the keyboard.

The Phone – Managing Settings

An optional phone feature is available for your Omnii hand-held. This section details how to tailor phone settings like the ring type and tone, phone services, and so on.



IMPORTANT For details about sending and ending calls, making conference calls, managing contacts, and so on, refer to [“The Phone” on page 3-4](#).

You can adjust phone settings such as the ring type and tone, choose phone services such as barring calls, and so on. There are a number of ways you can access phone settings.

- In the Navigation Bar, tap on the **Phone Settings** hotkey.

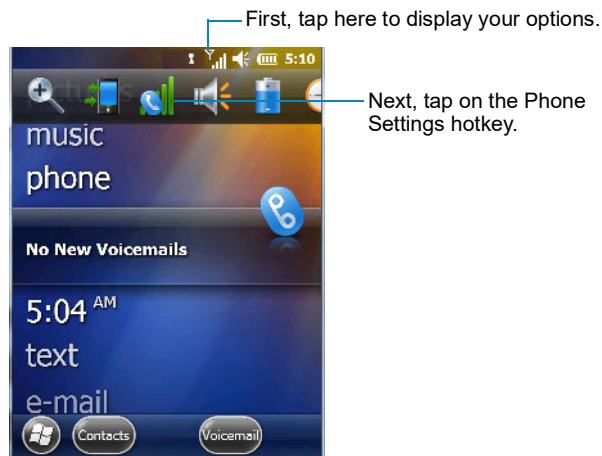

- In the pop-up Phone bubble, tap on the **Settings** link, or

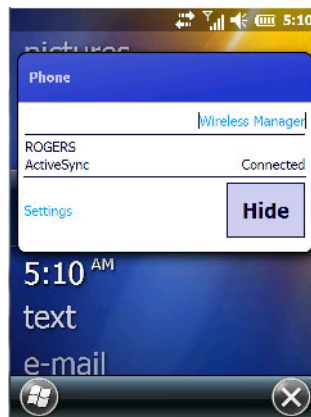

Tap on **Start>Settings>Personal icon>Phone icon**.

Phone: Sounds Tab

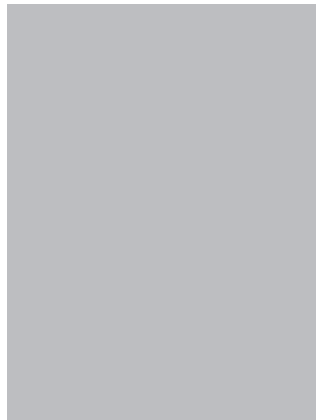

Ring Type and Ring Tone

The SIM card phone number is displayed at the top of this screen. The Ring Type drop-down menu allows you to tailor the type of ring used for incoming calls. The Ring Tone drop-down menu allows you to determine the ring tone of incoming phone calls. To test the ring type and tone you've chosen, you can tap on the Play button just below the Ring tone menu. Tap on the Stop button to end the sound test.



NOTE For details about setting up Ring type and Ring tone to help you identify other 'events' such as successful scans, missed calls, voice mails, and so on, refer to [“Notifications Tab” on page 4-13.](#)

Keypad

This option allows you to determine the type of sound that keypad keys emit as you press them. You can also turn off keypad sounds.

Phone: Security Tab

Tap in the checkbox (add a check mark) to enable PIN Security.

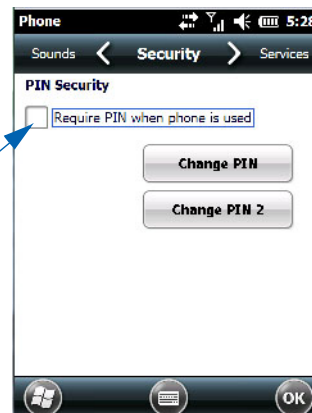

This option allows you to enable or change a PIN (Personal Identification Number) so that your phone function is protected from unauthorized use. Your SIM card manufacturer provides the default PIN which you can change in this field.

Changing a PIN

- Tap on the **Change PIN** button and use the phone keypad to enter your existing SIM card PIN. Tap on the **[Enter]** button in the phone keypad.

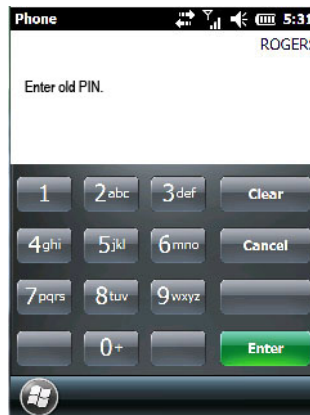
**IMPORTANT**

If you enter an incorrect PIN, a message is displayed letting you know that you'll need to reenter the correct value.

You have a limited number of chances to enter the correct PIN. The number varies for different services. If you exceed this number, the SIM will be disabled automatically. You will be asked to enter a PUK (Personal Unlocking Key). In some cases, the PUK is printed somewhere on your SIM package. If this is not the case, you will need to call customer support.

Once you've entered the correct PIN, a new screen appears asking that you enter your new PIN.

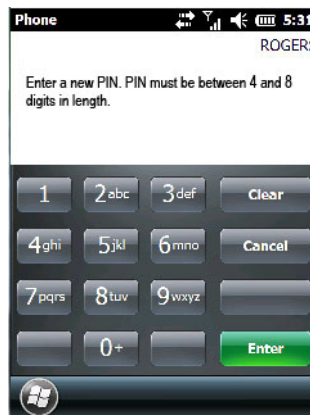

- Type your **new PIN** – a number consisting of between 4 and 8 digits. Tap on **Enter**.

A new message lets you know that you need to confirm your new PIN.

- Retype your **new PIN**. Tap on **[Enter]** when you're finished.

Enabling PIN Security

To activate PIN security:

- Tap in the **checkbox** to the left of Require PIN when phone is used.

When security is enabled, you will be prompted to enter a PIN before you are allowed to use the phone.



NOTE Whenever this option is enabled or disabled, you will be asked to enter your PIN.

Phone: Services Tab

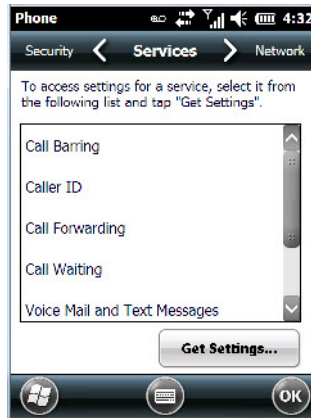

The Services tab allows you to customize the behaviour of your phone. You can, for example, block all incoming calls, tailor to whom your caller ID will be transmitted, set up call forwarding and so on.

NOTE Keep in mind that some services may not be supported by your network, or they may not have been subscribed to.

- Tap on the **service** you want to set up. Tap on **Get Settings**.

The service dialog boxes allow you to tailor your available services to meet your requirements.

Voice Mail Setup

If your service includes Voice Mail, choosing this option for the first time displays a screen in which you can enter your voice mail provider phone number.

Phone: Network Tab

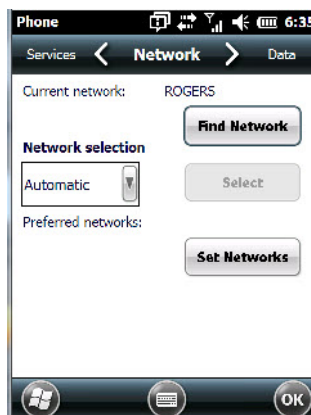

NOTE For details about choosing networks, refer to [Appendix G: “Wireless Wide Area Network \(WWAN\)”](#), “Network Configuration” on page G-8.

Phone: Data Tab

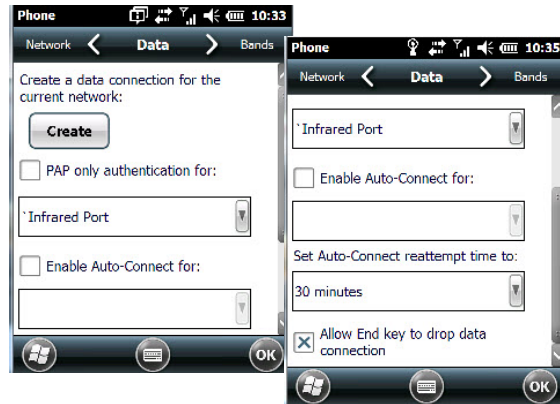

This screen is used to configure your WWAN data connection to the ISP.



NOTE For details about setting up your data connection, refer to [Appendix G: “Wireless Wide Area Network \(WWAN\)”](#), “Establishing a Packet Data Connection” on page G-3.

Phone: Bands Tab



By default, all frequency bands are enabled. Bands should not be disabled without knowledge about which bands are used by your network; an incorrect setting will prevent the WWAN modem from finding the network.

Phone: Diagnostics Tab

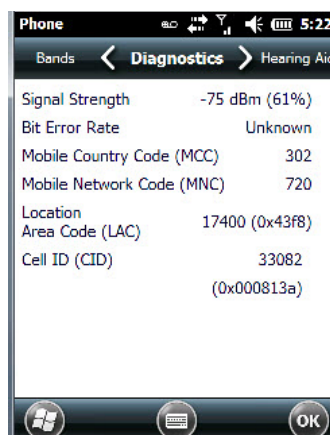

The Diagnostics tab lists details about each network found. The information in this screen may be useful to support personnel if they are attempting to diagnose a problem with your network.

Phone: Hearing Aid Mode Tab

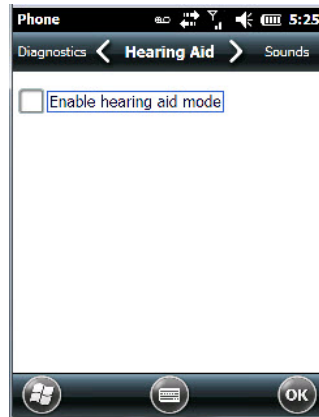

When Hearing Aid Mode is enabled, the audio path is altered to accommodate those using a magnetically coupled hearing aid (T-coil).

System Folder

- Tap on **Start>Settings>System** icon to display a group of system apps.



About

Tapping on Start>Settings>System tab, and then the About icon displays a grouping of tabs that provide device information.



Version Tab

This tab outlines the Windows Embedded Handheld 6.5 Professional version, processor information, memory size and a description of the expansion card, if one is in use.

Device ID Tab

This tab provides fields in which you can assign a Device name and Description (optional) for the Omnii. This name is used by the Omnii to identify itself to other devices.

Keep in mind that this must be a unique name across a network. If you are unable to connect to a network because another device with the same name is already connected, you'll need to assign a new name here.

Copyrights

The Copyrights tab lists the copyright information for the software loaded on your Omnii.

Backlight – Screen and Keypad

Tapping on Start>Settings>System icon followed by the Backlight icon allows you to determine the backlight and power properties of the Omnii.



Battery Power Tab

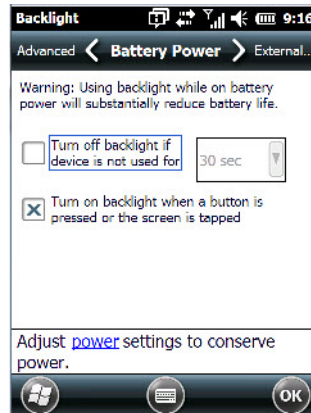

This tab allows you to tailor the Omnii backlight behaviour to best preserve battery life.

- To define how long the backlight should stay on when the Omnii is not in use, tap in the checkbox to the left of **Turn off backlight if device is not used for**.



NOTE This option is essentially 'suspend' mode. If the backlight is turned off, tapping on the screen or pressing a key displays the screen in which you were working before the backlight turned off.

- Tap on the drop-down menu, and choose the number of seconds or minutes the backlight will remain on when the hand-held is idle.
- To **Turn on backlight when a button is pressed or the screen is tapped**, tap in the checkbox to the left of this option.

External Power Tab

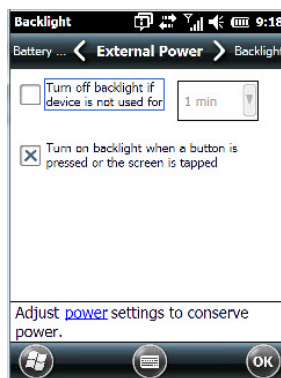

This tab determines the behaviour of the backlight when the hand-held is using external rather than battery power. Refer to the instructions in [“Battery Power Tab” on page 4-59](#) for details.

Backlight Tab

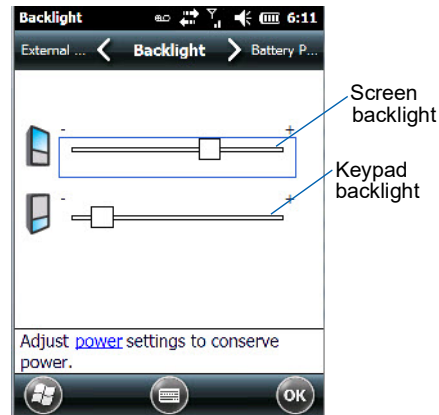

This tab allows you to tailor the backlight behaviour of the Omnii screen and keypad to best preserve battery life. The top sliding button adjusts the screen brightness while the bottom sliding button adjusts the keypad brightness.

- Slide the buttons to the left to decrease brightness and to the right to increase brightness.

Certificates

- Tap on **Start>Settings**, and then tap on the **System** icon.
- Tap on the **Certificates** icon.

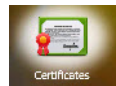

A public key is transmitted as part of a certificate. The certificates listed in the Certificates tabs ensure that the submitted public key is, in fact, the public key that belongs to the submitter. The hand-held checks that the certificate has been digitally signed by a certification authority that the hand-held explicitly trusts.

Your Omnii has certificates already preinstalled in the unit. Personal certificates establish your identity, intermediate certificates, as the name suggests, identify intermediate certification authorities and root certificates establish the identity of the servers with which you can connect.

Choosing a Certificate

Normally, certificates already configured for your network are chosen automatically by the Omnii. If a certificate cannot be chosen automatically, you must choose it from the Certificates list.

- To choose a certificate, tap the desired certificate. Your Omnii will connect automatically.

Personal Tab

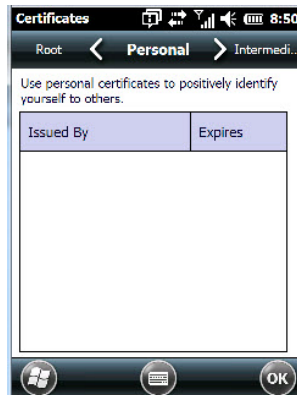

The Personal tab lists the name of the certificate issuer and the expiration date.

- To view additional information about a personal certificate, tap on a **certificate** in the list.
- To delete a certificate, tap and hold the stylus on the item you want to delete until a pop-up menu is displayed. Tap on the **Delete** command.

Intermediate Certificates

The items in this list help identify intermediate certification authorities.



Root Certificates

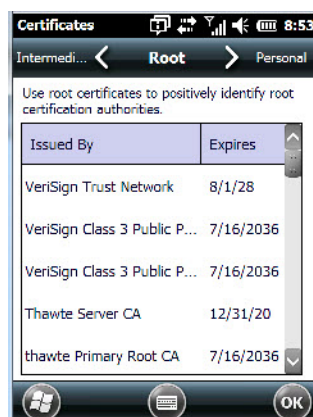

- To view details about a certificate – who issued the certificate, to whom it was issued, the issue date and the expiry date – tap on a certificate in the list.

- To delete a certificate, tap and hold the stylus on a certificate. In the pop-up menu, tap on **Delete**.

Compass

Like all compasses, the Omnii compass indicates the direction in which the unit is pointed.

- Tap on **Start>Settings**, and then tap on the **System** icon.
- Tap on the **Compass** icon.

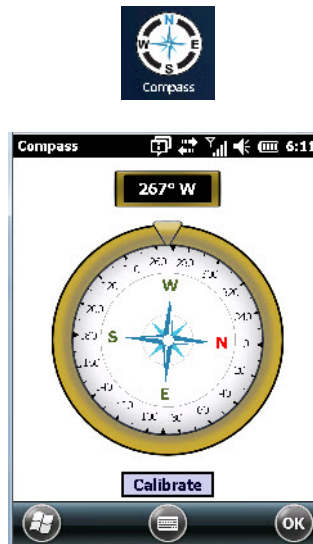

If you find that the compass is inaccurate, you may need to calibrate it.

- Tap on the **Calibrate** button and follow the directions to calibrate the compass. Make certain that you perform the figure '8' indicated in the instructions in a fairly wide loop to better ensure successful calibration.

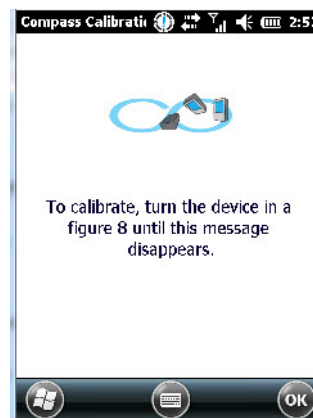

When the compass calibration is complete, a message appears on the Omnii screen indicating successful calibration.



NOTE The accuracy of the compass is affected by the following:

- close proximity to large magnets or metal structures, and
- internal scanner/imager activation.

Contrast

Tapping on the Contrast icon displays a screen in which you can tailor the screen contrast.

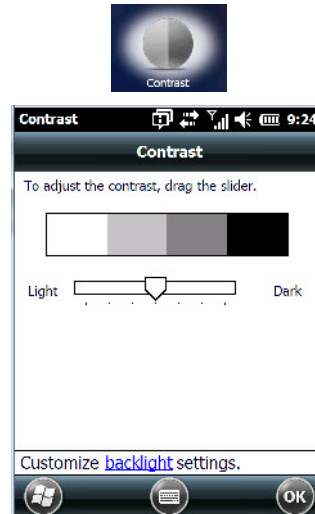

- Drag the sliding button between Light and Dark to achieve the desired screen colour contrast.

Customer Feedback

This option allows Microsoft to track how you use your Omnii so that they can make improvements to the software. The radio buttons in this screen allow you to turn this feature on or off.

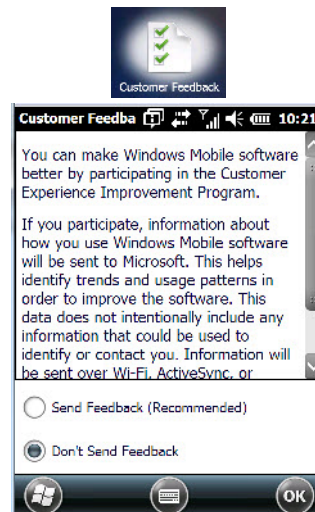

Dr. Debug

Dr. Debug is an error diagnostic tool.

- Tap on **Start>Settings>System**. Tap on the **Dr. Debug** icon.

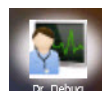

Status

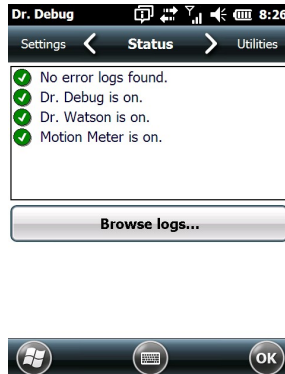

This tab indicates the status (on/off) of the tools. Tapping on Browse logs displays error logs for your review.

Utilities

There are a number of utilities available through Dr. Debug. The NetLog utility is used to log network traffic. The RiLog utility captures Radio Interface Layer (RIL) debug outputs. When you tap on the Start button, debug data is collected so that, if necessary, it can be forwarded to a Zebra technician for evaluation.

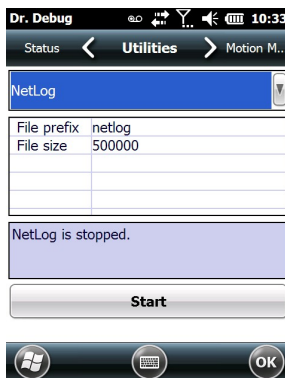

The Utilities tab also provides a HeaterLog that can be used to log heater control logic board information.



Motion Meter

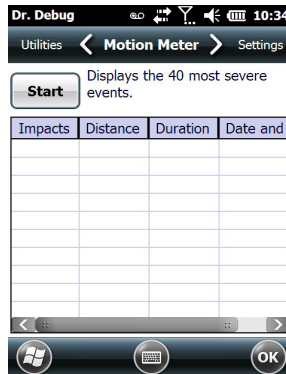

Tapping on the Start button enables the Motion Meter feature. Once enabled, this applet records the number of impacts the Omnii has sustained, the distance of the fall in meters, the duration in 10ths of a second, and the date and time that the event occurred. The top 40 events are logged in a non-volatile location and can be used for diagnostic purposes by Zebra or the site administrator.

Settings

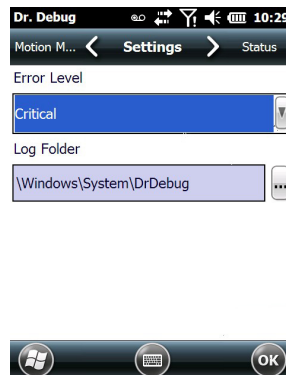

- Choose an **Error Level** from the drop-down menu.
- To change the location where debug information will be stored, tap on the button to the right of the Log Folder option.

Encryption

This option allows you to encrypt the data on your storage card.

- Tap on **Start>Settings>System tab>Encryption** icon.



Error Reporting

Error Reporting allows you to enable or disable Microsoft error reporting prompts.

- Tap on **Start>Settings**. Tap on the **System** icon followed by the **Error Reporting** icon.

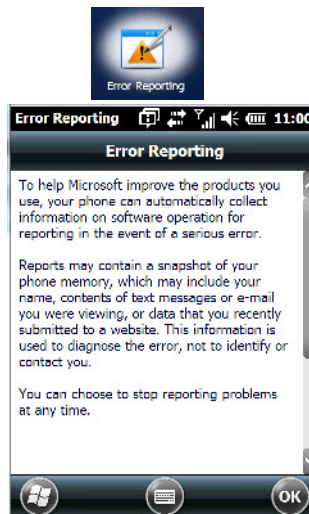

GPS (Global Positioning System)

With a Global Positioning System (GPS) receiver, you can locate your exact position on a map. However, even without a GPS receiver, several different mapping programs can run on your Omnii.

- Tap on **Start>Settings>System tab>GPS** icon.

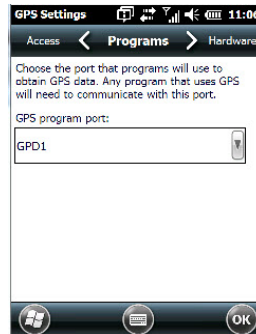

- Tap on the **GPS program port** drop-down menu, and choose the communication port that the GPS software will use to communicate with the GPS receiver.



NOTE Your Omnii may automatically detect the GPS receiver that you are using and enter the settings in the Hardware tab. If not, you'll need to enter this information yourself. You can find this information in the user manual of the GPS receiver.

Windows Embedded Hand-Held automatically manages access to the GPS receiver. However, some programs may not work with automatic configuration. If this is the case:

- Tap on the **Access** tab, and disable Manage GPS automatically (recommended).

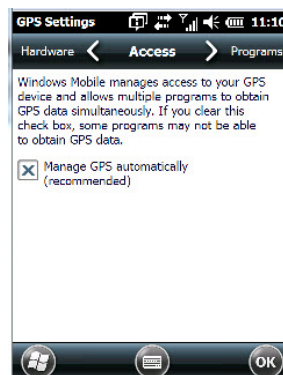

You can go to:

<http://www.microsoft.com/windowsphone/en-gb/howto/wp7/web/use-maps-to-find-a-place.aspx>

if a map-viewing program is not included with your Omnii, and copy the file to your Omnii.

- Tap on the **Hardware** tab, and set the GPS hardware port to **COM2**. Set the Baud rate to **4800**.

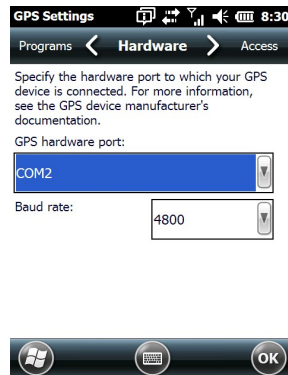

GPS (Global Positioning System) Settings

This applet allows you to define how the GPS module operates. You can determine when the GPS module can draw power and under what conditions, and choose from a set of GPS profiles built into the modem. You can also set up AGPS (Assisted Global Positioning System).

- Tap on **Start>Settings>System>GPS Settings** icon.

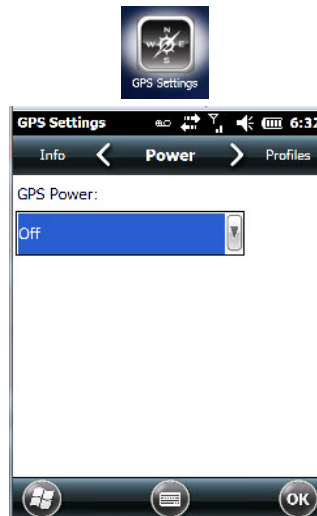

Power Tab

This tab allows you to dictate how the GPS module behaves. The GPS Power drop-down menu is used to control when the GPS is powered on and off.

- Off – the GPS module is left off, always.
- Always on – the GPS module is powered on at all times regardless of the power state of the Omnii (suspend mode).
- On, and off in suspend – the GPS module is powered on, but if the Omnii is in suspend mode, the GPS module is turned off.

Profiles

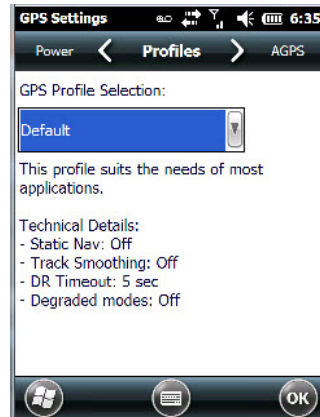

Tapping on the GPS Profile Selection drop-down menu allows you to choose an appropriate profile: Default, Automotive or Pedestrian.

- Default profile is a good general profile suitable for most uses.
- Automotive profile is designed for in-vehicle use, providing quick location updates as the vehicle moves. When the GPS module is set to this profile and the vehicle enters an area such as a tunnel where satellite coverage is interrupted, it will attempt to predict the vehicle position.
- Pedestrian profile is designed for those using the GPS module while walking. It takes into account the slower pace of the pedestrian when mapping the location of the user. When the GPS module is set to this profile and the operator moves into an area where satellite coverage is interrupted, the GPS module will not attempt to predict the operator's movement.

AGPS (Assisted Global Positioning System) Tab



To determine your location, a GPS module receives data from three or more GPS satellites in fixed orbit around the Earth. The GPS module triangulates your location based on the time it takes for signals to get to and from the satellites. This works well in fairly clear areas – outdoors, for example. However, if you're attempting to triangulate your location in city centres where signals bounce off tall concrete buildings or from within a building, the GPS module will have greater difficulty calculating a fix.

AGPS reduces Time To First Fix (TTFF) and increases the likelihood of finding and keeping a fix in poor coverage areas such as indoor sites. AGPS downloads satellite ephemeris (orbital) data to the Omnii periodically through Wi-Fi or WWAN. The downloaded data is used by the GPS module to speed the process of getting a fix.

Update

- Click on the **Update** button to download Extended Ephemeris (EE) files from a secure host on the internet using any interface that has an internet connection (WWAN or Wi-Fi). These files contain several days worth of ephemeris (orbital) data that can be used if the satellite's broadcast ephemeris is not available.

The Status field above the Update button displays the progress of the download, and once successfully downloaded, the Status field will read Idle.

Settings

- Click on the **Settings** softkey to define the AGPS server connection settings.

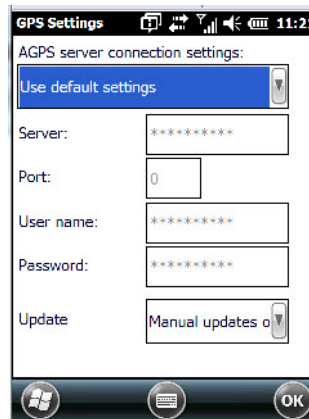

The AGPS server connection settings drop-down menu allows you to choose from two settings: Use default settings and Use custom settings.

The Use default settings option is generally acceptable for most applications. Note that aside from the Update field in which you can choose how long the fix is stored in your Omnii, the field values cannot be edited.

The Use custom settings option is generally used to configure devices that will have access only to an intranet rather than the Internet and should only be altered with the assistance of qualified Zebra personnel. They will be able to help you configure your Zebra device(s) and web server to retrieve the ephemeris data.

Info Tab

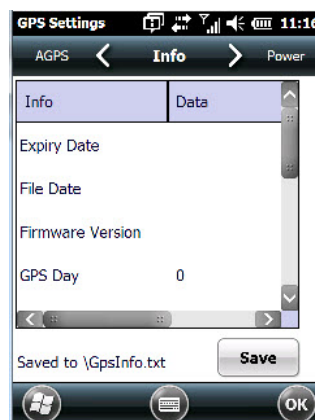

This tab provides general information about the GPS module such as the firmware version, the date on which files were last updated, and so on. If GPS module support service is required, you may be asked to tap on the Save button in this tab and forward the information to Zebra support staff.

Imagers Settings

The Imagers applet is used to create, modify, delete and activate imager settings. The principle uses of the applet are to decode barcodes and to capture images.

To launch this applet:

- Tap on **Start>Settings>System**, and then tap on the **Imagers** icon.

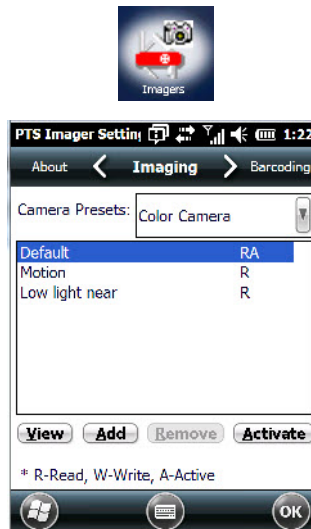

IMPORTANT Refer to [Appendix B: "Imagers Applet"](#) for setup details.

An Imager & Camera demo applet is also provided to illustrate how the imager and camera work.

To launch the demo applet:

- Tap on the **Start>Demo** folder icon. Then, tap on the **Imager And Camera** icon

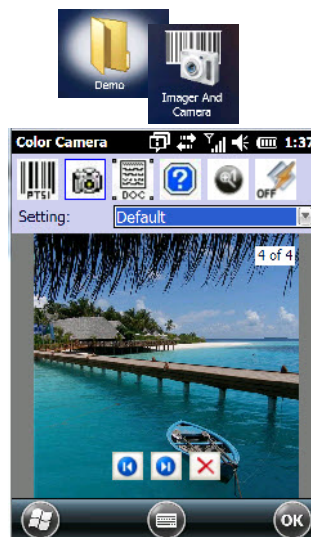

NOTE You can also launch the Imager Applet from within the demo screen. Tap on the Settings drop-down menu and choose Advanced.

Manage Triggers

Manage Triggers allows you to configure how barcode scanners and other devices are triggered. You can configure the trigger ID for each trigger button for both single- and double-click, and the double-click time.

- Tap on **Start>Settings>System>Manage Triggers** icon.

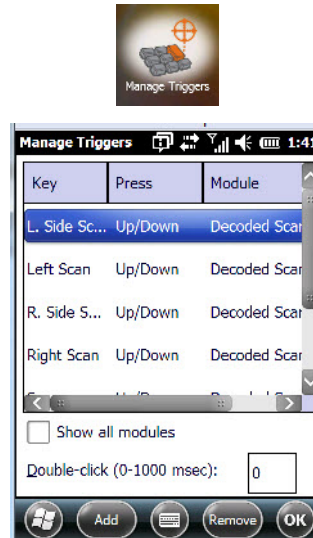

Trigger Mappings

A trigger mapping is an association between a particular key on the keyboard and a driver or application, the module(s) – sometimes referred to as “trigger consumer(s)” – of the trigger source. Along with keyboard keys, trigger sources can also be grip triggers, external hardware triggers or software-based. When the specified key is pressed, the trigger consumer (for example, a decoded scanner) is sent a message.



IMPORTANT

It is not possible to have two or more identical mappings — for example [F1] cannot be mapped to the Non-Decoded Scanner twice — even if the trigger type is different.

A keyboard key that is used as a trigger source will no longer generate key data or perform its normal function. For example, if the space button is used as a trigger source, it will not be able to send space characters to applications.

Double-Click

When a key is pressed and released, then pressed again within the configured time (between 0 to 1000 milliseconds), a double-click occurs. See also “[Trigger Press Type](#)” on page 4-74.

Show All Modules

By default, the trigger mapping list only shows active mappings. Mappings for drivers or applications that are not currently active are not normally displayed. By checking this checkbox, all mappings, both active and inactive, are displayed.

Add

Tapping this button brings up the Add mapping dialog (see below), so that you can add new trigger mappings.

Edit

Tapping this button brings up the Edit mapping dialog, so that you can edit existing trigger mappings.

Remove

Tapping this button removes an existing mapping.

OK

The OK button in the Manage Triggers screen saves all changes made. If the [ESC] key is pressed, all changes are discarded.

Add and Edit Trigger Mapping

- Tap on **Add** to add a new trigger map, or tap on **Edit** to edit an existing trigger map.

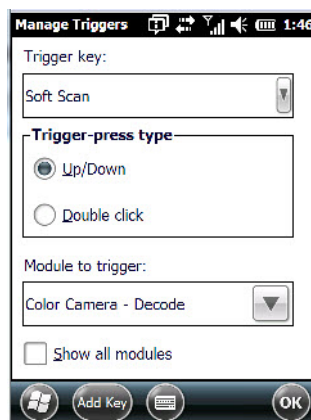
**Trigger Key**

This drop-down list allows you to specify the source of the trigger events, such as the Grip Trigger, Left Scan, etc., for the trigger module selected.



NOTE It is possible to map the same source to different modules (trigger consumers) – for example, to both the Imager and Non-Decoded Scanner. If so, both devices/operations will occur simultaneously. This is not recommended in most cases, especially with devices such as Imagers.

It is also possible to map different sources to the same module (trigger consumer).

Add Key

Only existing trigger sources are shown in the Source combo-box. To add a new source to this list, tap on the **Add Key** button. A dialog box pops up, allowing you to select the keyboard key to use as a trigger source.

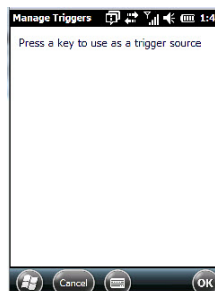

Trigger Press Type

You can enable either an **Up/Down** or **Double Click** response to a trigger press. Normally, when a trigger (keyboard key, etc.) is pressed and released, a “trigger down” event is sent to the “owner” – that is, the application receiving the trigger press information – followed by a “trigger up”. If Double Click is chosen in this menu, when the trigger is pressed, released, and then pressed again, a “double-click” event will occur. If a mapping with the Up/down type has also been configured for the same source, it will only receive the first set of trigger events.

Module to Trigger

This identifies the driver or application receiving the trigger presses.

Show All Modules

By default, inactive owners are not shown. By checking this checkbox, all owners, both active and inactive, are displayed.

Managed Programs

Managed Programs lets you view, download and install applications that are deployed by the System Center Mobile Device Manager (a server-side solution that helps enable IT to have control of their device deployment with respect to security, management and access to the corporate network).

To access Managed Programs:

- Tap on **Start>Settings>System tab>Managed Programs** icon.

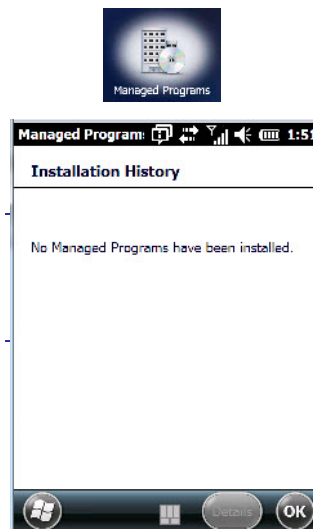

NOTE The system administrator can provide the details needed Managed Programs effectively.

Memory

This applet allows you to view memory use and storage card memory allocation. To display the options for this applet:

- Tap on **Start>Settings**. Tap on the **System** tab followed by the **Memory** icon.

Main Tab

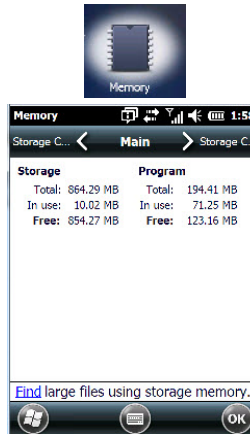

This tab lists the memory allocated for file and data storage and for program storage.

Storage Card

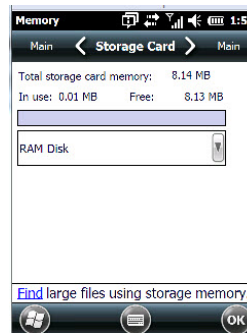

The Storage Card screen indicates the total storage card or RAM disk memory along with the amount in use.

Microphone

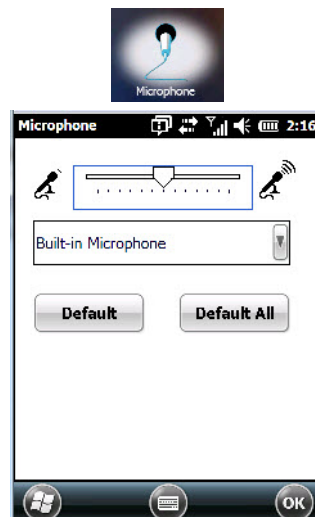

Use this dialog box to adjust the gain for the specific microphones associated with your hand-held.

- Tap on the drop-down menu, and choose the microphone for which you want to adjust the gain.

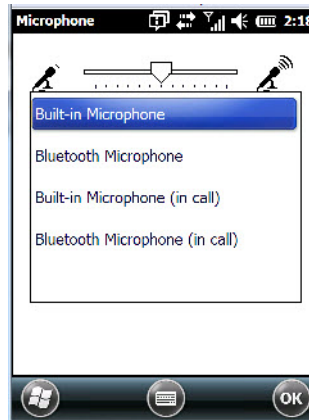

- Slide the tab at the top of the dialog box to the left to decrease the gain and to the right to increase the gain.

Tapping on the Default button sets the current microphone you've chosen to the default gain. Tapping on Default All sets all microphones listed to their default gain.

PartnerUp



Tapping on this icon displays a number of pre-loaded applications. Tapping on an app in the list takes you to an associated web site.

The operator can then install the application. If a license is required, it can be obtained by sending an e-mail to the software license mailbox or by contacting a Sales Rep from the Zebra contact web page.

http://www.zebra.com/US-EN/Pages/Contact_Us/?WT.mc_id=psion_us_about_contact_pSION-offices

Additional pieces of software such as a server must be obtained through Zebra.

Tapping on a preloaded client in the PartnerUp screen displays a drop-down menu from which the operator can choose from an array of related options.

Quick Defrost (Heater Settings)



The Quick Defrost applet provides a number of tools to monitor and configure the heaters installed in the Omnii XT15f freezer units.

Kiosk

Kiosk allows the administrator to tailor how the Omnii operates and the options the user can access. Note that the look of the Today screen will change from icons that are finger accessible to a list of items best accessed using a stylus.

- Tap on **Start>Settings>System>Kiosk** icon.

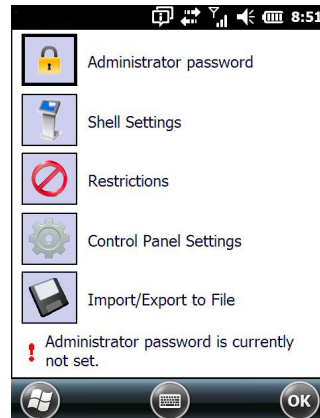

If an administrator password is not yet set, this is indicated at the bottom of this screen. Tapping on the Administrator Password option displays the following screen.



- Type a **New password**, and then re-enter it in the **Confirm new password** field.



NOTE Once an administrative password is assigned, each time Kiosk is launched, a dialog box will be displayed requesting the password.

Kiosk Menu

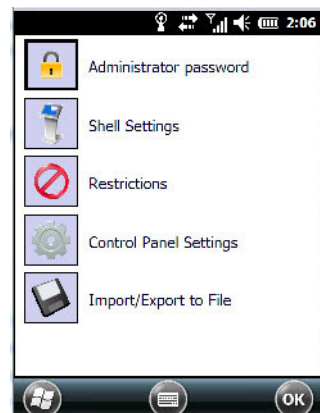

The Kiosk menu provides access to the categories to help you tailor the look and operation of the Omnii for the user.

Administrator Password

If you want to change an existing password, you need to complete the Administrator Password screen:

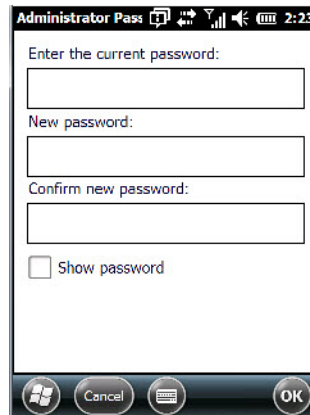

- Tap on the **Administrator password** option, and type your **current password**.
- In the next field, type a **New password**. Retype the new password in the **Confirm new password** field, and tap on **OK**.

Shell Settings

The Shell Settings option allows the administrator to tailor what operators see and what is available to them when Omnii is powered on. Note that these changes are not visible until the unit switches from Administrator Mode to User Mode. A Kiosk Access screen, the screen in which you can switch from Administrator to User Mode, is displayed automatically once you've finished making changes and have tapped on OK.

Applications Tab

This tab allows the administrator to choose the applications that will be available to the user.

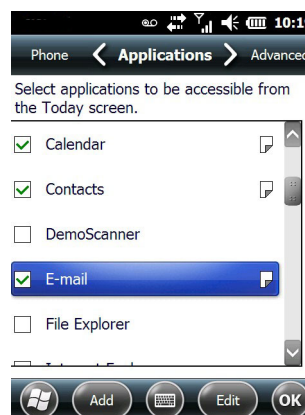

- Tap in the **checkbox** next to each application you want displayed on the Today screen.

Once the Omnii is set to User Mode, the selected items from the Application screen are listed in the Today screen. A Kiosk Access screen, the screen in which you can switch from Administrator to User Mode, is displayed automatically once you've finished making changes and have tapped on OK. See "Activating a Change – User Mode" on page 193 details.

The look of the Today screen differs significantly from the original version, appearing as a list of available items more suitable for a stylus than finger touch.

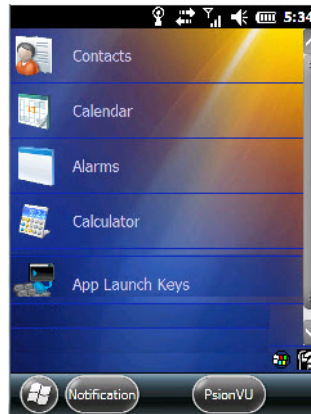

Adding Applications

The Add and Edit buttons allow you to search for applications in the storage areas on your Omnii (e.g., Windows, My Device, etc.), and add applications to the list of items in the Today screen.

You can add a maximum of 18 applications, after which the Add button is greyed out, and the following message is displayed: Maximum 18 entries reached.

- To add additional applications that will be accessible to the user from the Today screen, tap on the **Add** button at the bottom of the Application screen. The Select File screen is displayed.

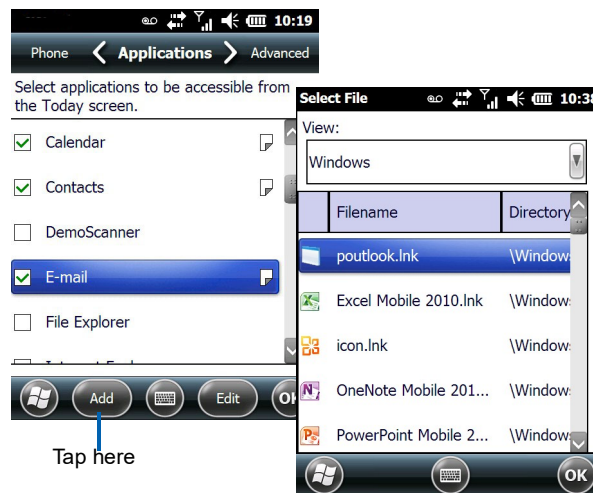

The View drop-down menu at the top of this screen displays the storage areas in the Omnii.



Tapping on a storage area – Windows for example – displays the applications you can add to the Today screen from that storage area.

Advanced Tab

This tab provides a number of options to restrict what is available on start up.

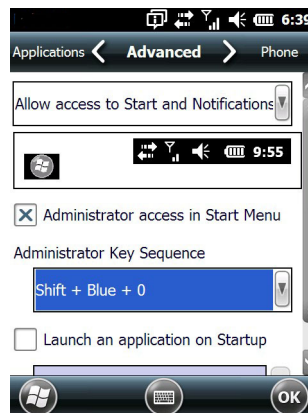

Start Button and Notification Restrictions

The drop-down menu at the top of the Advanced tab allows you to limit access to the Notifications at the top of the screen and the Start button at the bottom of the screen.

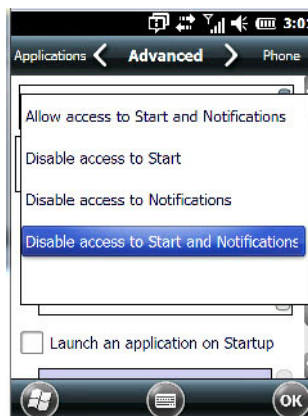

When you choose an option, for example, Disable access to Start and Notifications, the sample bar below the drop-down menu marks the disallowed items in red.

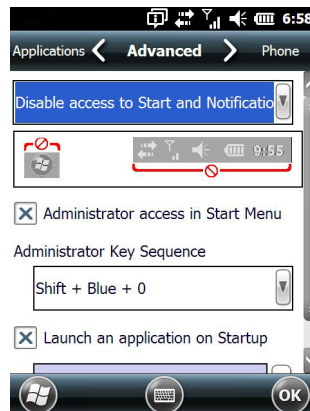

Kiosk App Restrictions

To remove Kiosk from the Start screen:

- Tap in the **checkbox** next to Administrator access in Start Menu to deselect it. The x should not be present in the checkbox.

The Administrator Key Sequence drop-down menu provides three key sequences you can use to gain access to Kiosk when it is not accessible from the Start screen.

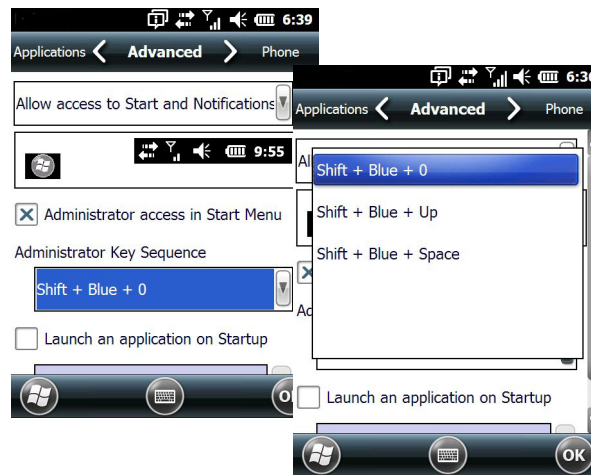

i **NOTE** If you disable “Administrator access in Start Menu” or if you “Disable Start”, the only way to access Kiosk or the Start screen applications is to type an “Administrator Key Sequence”. In these cases, it is important that you make note of the key sequence you’ve chosen.

Launching an Application at Startup

If you enable Launch an application on Startup, a screen is displayed where you can choose the application that will be launched automatically when the Omnii is powered up.

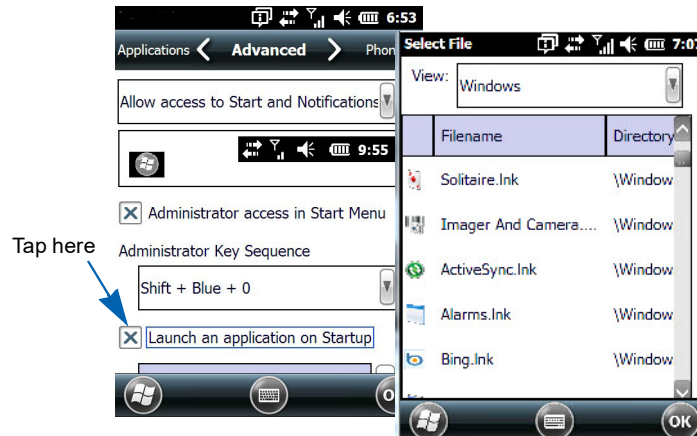

- Tap in the checkbox next to **Launch an application at Startup**.
- Tap in the **View** menu at the top of the Select File screen, and choose the storage area from which you want to choose an application.
- Next, tap on the **application** you want the Omnii to launch on startup.

Your choice is displayed in the Advanced tab.

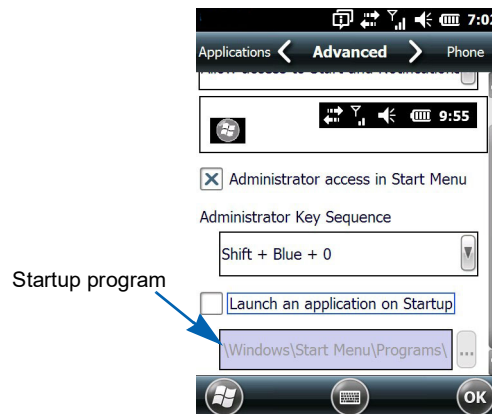

- Tap on **OK**.



NOTE Remember that changes do not take effect until the Omnii is set to User Mode and the unit is reset.

Phone Tab

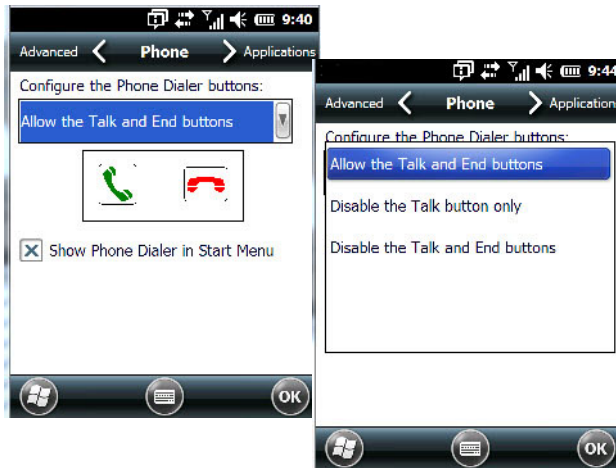

The Phone tab allows you to define the phone buttons accessibility on the Omnii keyboard by choosing an item from the Configure the Phone Dialer buttons drop-down menu.

NOTE Remember that changes do not take effect until the Omnii is set to User Mode and the unit is reset.

Restrictions

The Restrictions screen allows the administrator to restrict access to applications.

NOTE Remember that changes do not take effect until the Omnii is set to User Mode and the unit is reset. Refer to [“Activating a Change – User Mode”](#) on page 4-87.

Application Tab

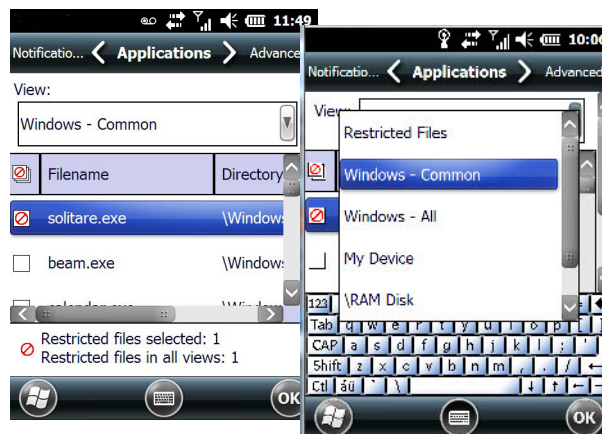

Tapping in the View menu displays a drop-down menu where you can define restrictions for each storage area of the Omnii. Restricted items are marked in the checkbox to the left – in the sample screen above, solitaire.exe is restricted.

Advanced Tab

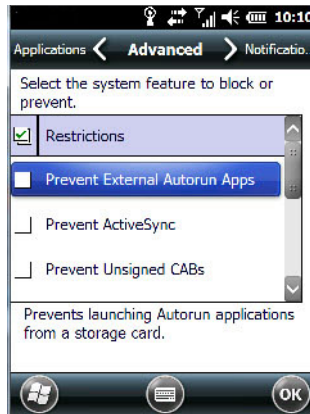

The Advanced tab lists system features you can block from user access. Tapping in the checkbox to the left of a feature adds a check mark indicating it is blocked.

Notifications

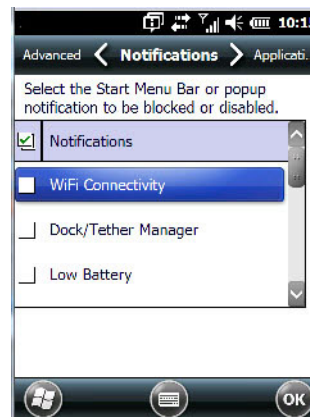

The Notifications tab allows you to choose which pop-up notifications are blocked from user view.

Control Panel Settings

This options allows you to tailor items displayed in both the Settings screen and in the Today screen.



NOTE Remember that changes do not take effect until the Omnii is set to User Mode and the unit is reset. Refer to [“Activating a Change – User Mode”](#) on page 4-87.

Hide Tab

The Hide tab under the Control Panel allows you to determine which applications will be hidden in the Settings screen that is displayed when the operator taps on the Start button.

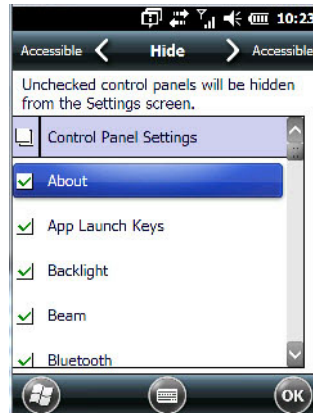

Remember that only unchecked items in this list are hidden.

Accessible Tab

The Accessible tab allows you to choose which items will be accessible in the Today screen.

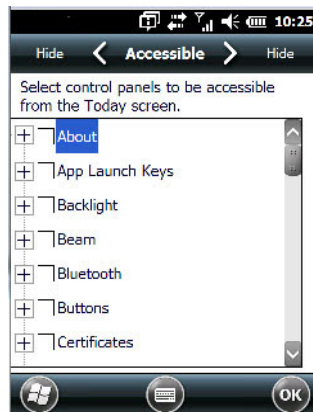

Import and Export Settings

This option enables you to Export your settings file (.xml), and save it in the location of your choice. In addition, an administrator has the option to Import these settings from one device to multiple devices of the same operating system.



IMPORTANT

A copy of this file should also be saved in a central repository for all Zebra .xml files with a predefined name so that other Zebra utilities can locate it.

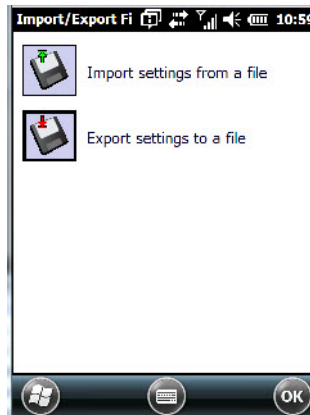

Tapping on the Export button displays an Export Settings screen. The default Name – Kiosk_Settings – can be changed by the administrator even after it has been saved.

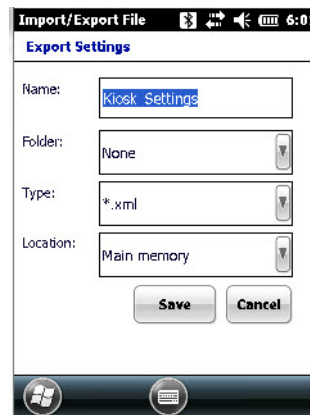

The .xml file contains all of the Kiosk configured settings, including the Administrator Password. When the file is imported to a device, the new password is applied immediately.

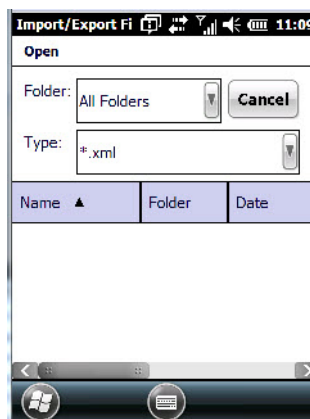

- Whether choosing to import or export files, the same file location options will be listed. Following the action, a message stating the success of the operation and the location of the file is displayed.
- With the exception of the password, changes made to settings take effect only after a warm reset. If further changes to the configuration are made, they will overwrite the changes caused by the import operation. After importing a file, a dialog box appears requesting a reset now or later.

Activating a Change – User Mode

To activate changes, you'll need to switch from Administrator to User Mode. This Kiosk Access screen is displayed automatically once you've finished making changes and have tapped on OK.

- In the tab where you've made the changes, tap on **OK**. In the next screen – the Kiosk menu screen – tap on **OK**.

A new screen, the Kiosk Access screen, is displayed.

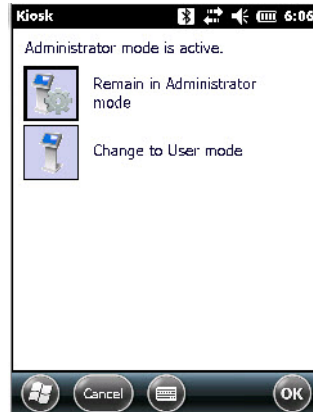

- Tap on **Change to User mode**.

You'll need to reset the Omnii so that the changes you specified can take effect.

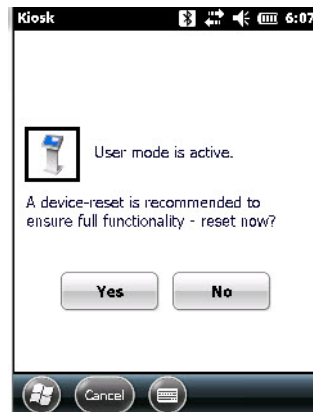

- Tap on **Yes** to reset the Omnii and activate your changes.

Regional Settings

To display the Regional Settings screen, tap on **Start>Settings**, and then tap on the **System** icon followed by the **Regional Settings** icon.

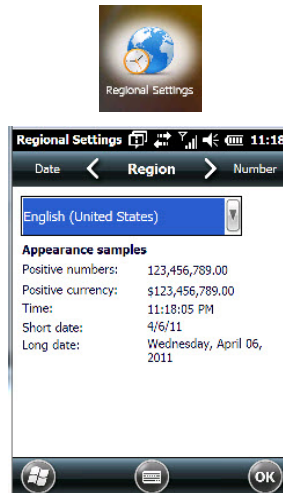

- Tap on the drop-down menu to choose your language and region.

Once you've selected a language and region, you may need to adjust the way numbers, currency, the time and the date appear in your Omnii.

- Tap on the tab associated with each of the items, and choose how each item should be displayed on the unit.

Remove Programs

- Tap on **Start>Settings**. Tap on the **System** icon followed by the **Remove Program** icon.



Tapping on the Remove Programs icon displays a screen listing the programs that can be removed from the unit.

- To remove a program, highlight it and then tap on the **Remove** button.

Scanner Settings



IMPORTANT Refer to [Appendix C: “Scanner Settings”](#) for additional details.

The Scanners icon in the Settings menu provides access to dialog boxes in which you can tailor barcode options.

- Tap on **Start>Settings**, and then tap on **System** followed by the **Scanners** icon.

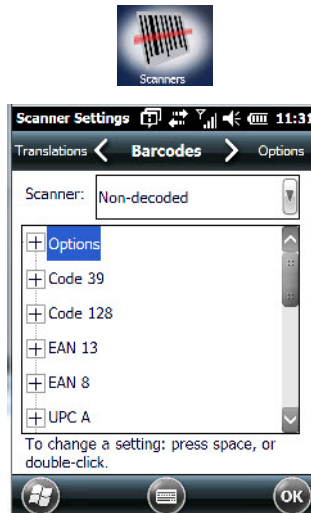

Restoring Default Settings

If you want to restore the factory defaults after making changes, the defaults can be applied to a selected parameter, sub-tree of parameters, or all scanner parameters.

- Press and hold the stylus on a symbology to display a pop up a menu.

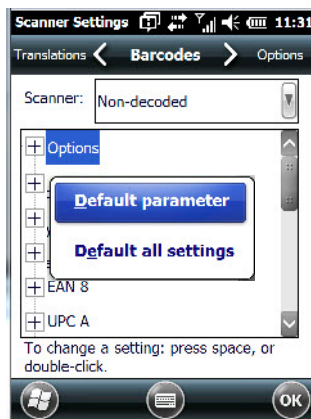

- Choose **Default parameter** to reset only the parameter you selected, or choose **Default all settings** to reset all scanner parameters to default settings.

Options Tab

The Options tab allows you to tailor the double-click parameters and the display options associated with your scanner.

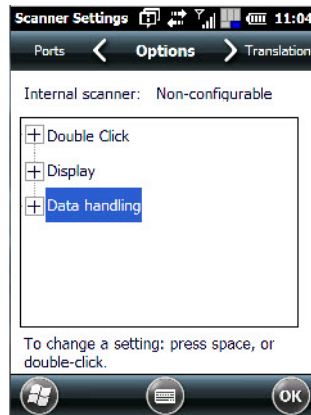

Double Click Parameters

Click Time (msec)

This parameter controls the maximum gap time (in milliseconds) for a double-click. If the time between the first and second clicks of the scanner trigger is within this time, it is considered a double-click. The allowable range is 0 to 1000. A value of zero disables this feature.

A double-click produces different results depending on whether or not a value is assigned in the “Click Data” parameter. When a value is not assigned for the “Click Data”, double-clicking the scanner trigger overrides the target dot delay set in the “Dot Time” parameter and initiates a normal scan sweep. If a value is assigned for the “Click Data” parameter, double-clicking the scanner trigger inserts the “Click Data” value rather than initiating a scan.

Click Data

For both integrated and external scanners, this parameter determines which character is sent to the application installed in your Omnii following a double-click. A dialog box appears, asking that you press the key you want to insert. The ASCII/Unicode key value of the keypress is displayed.

Display Parameters

Scan Result

When this parameter is enabled, the type of barcode and the result of the scan appear on the screen. Note that this information is only displayed after a successful decode and is visible only while the scanner button is pressed. When the button is released, this information is cleared from the screen.

Scan Indicator

When this parameter is enabled, the laser warning logo appears on the display whenever the scanner is activated.

Scan Result Time (msec)

The value assigned to the “Scan Result Time (sec)” parameter determines how long the scan results of a successful scan are displayed on the screen. Time is measured in seconds, and a value of “0” (zero) disables the parameter. When you choose this option, a dialog box appears where you can enter a value.



NOTE To remove the scan result from the screen before the “Result Time” has expired, point the scanner away from the barcode and press the trigger.

Good Scan Beep and Bad Scan Beep

These parameters determine whether or not the Omnii emits an audible scanner 'beep' when a good (successful) scan or a bad (unsuccessful) scan is performed, the number of vibrates, the duration of the vibrate, and so on. Set these parameters to tailor the behaviour of this parameter.

Multiple Beep Tones

This parameter determines whether or not multiple beeps will be allowed.

Good and Bad Scan Vibrates

These parameters determine whether or not the Omnii will vibrate (rather than beep) when a good (successful) scan or a bad (unsuccessful) scan is performed. Set these parameters to either on to enable the beeper or off to disable it. You can further refine how you want the vibrations to behave, specifying the following: Number of Vibrates, Duration of Vibrate (in milliseconds), and Pause between Vibrates (in milliseconds).

Soft Scan Timeout

This parameter is used by the SDK "Scan" function (soft-scan: starting a scan session via the SDK function, instead of a physical user trigger press). The value assigned to this parameter determines the soft-scan timeout from 1 to 10 sec. (default is 3 sec.).

Scan Log File

If this parameter is enabled, the input barcode and the modified/translated output barcode are logged in the file \Flash Disk\ScanLog.txt. Keep in mind that if the "Scan Log File" is enabled, there is a slight performance effect when performing multiple scans since the log file is written to persistent storage.

Data Handling

This option allows you to choose the code page your Omnii will use to display data – Default Local ASCII or ISO-8859-1 Latin 1.

Codepage:

Tapping on this option displays a window in which you can define the code page your Omnii will use.

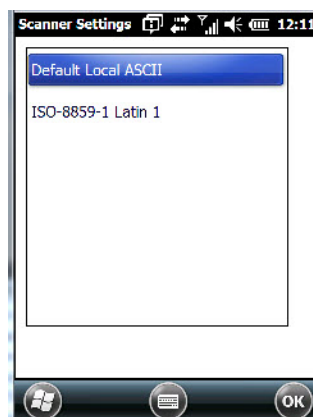

If you choose Default Local ASCII, the code page of the local OS is used. For example, if the local OS uses double-byte Chinese characters, choosing this option will filter data through the local ASCII of that OS and display it accurately, in this example, using double-byte characters.

If you choose ISO-8859-1 Latin 1, data will be displayed according to the character mapping of this Latin 1 code page, ignoring the local OS code page.

Translations Tab

The Translations tab allows you to define up to 10 cases, each consisting of up to 10 rules in sequential order. Only one case will be applied to a barcode and a case will only be applied if all rules specified in the case are successful – if a rule within a case fails, the entire case fails.

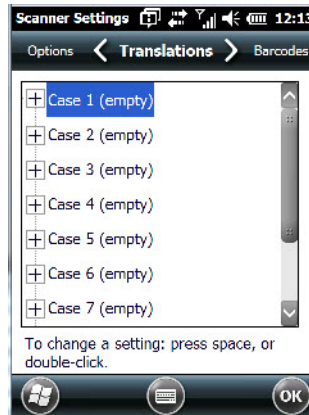

- In the Translations tab, double-tap on a **Case #** to create rules.

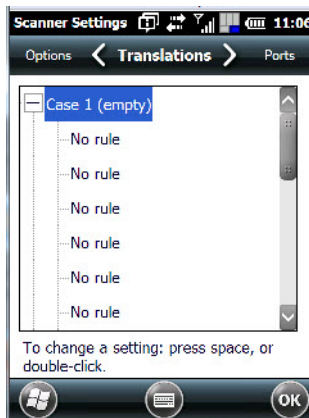

- Tap on the **No rule** drop-down menu to display the rules.

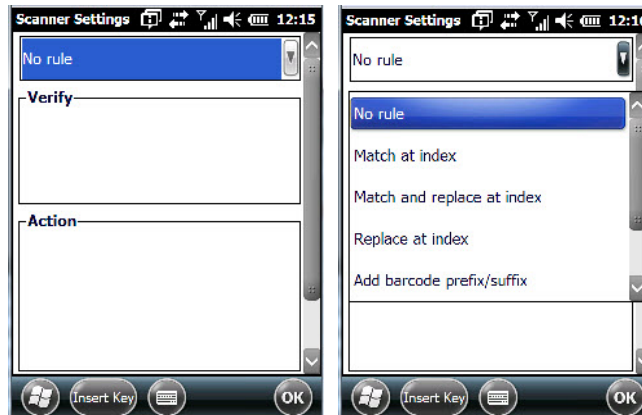

When you choose a rule, an associated screen is displayed in which you can define the rule.

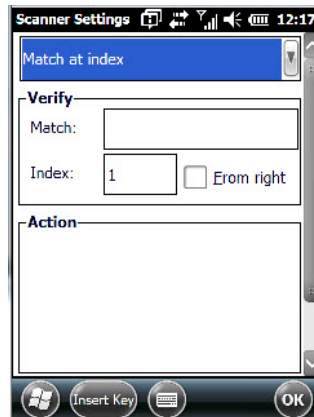

Case Rules

The case rules are defined as follows:

- **No rule** – ignored.
- **Match at index** – matches the match string at a specified index.
- **Match and replace at index** – matches the match string at a specified index and replaces/changes it.
- **Replace at index** – replaces/changes unspecified data in a given range.
- **Add barcode prefix/suffix** – adds a global prefix or suffix.
- **Verify barcode size** – verifies the barcode size. This rule should generally be assigned first, before creating subsequent rules.
- **Search and replace** – replaces all instances of the match string. (Note that this rule cannot fail.)



IMPORTANT

Keep in mind that the effects of previously applied rules must be taken into account when creating subsequent rules. For example, if the barcode size is important, it should be checked before any rules that might change the size are applied.

The information about the status of each case/rule is displayed in the scan log file (see [“Scan Log File”](#) on page 4-91) when enabled. This is useful if a case fails, and you are trying to determine why a rule is failing.

Port Replicator Port A (COM5) and Port B (COM6)

Port Replicator Port A (COM5) and Port B (COM6) are standard RS-232 DE-9 DTE ports on the Omnii port replicator module, available on some snap modules and cradle types.

Enabled

This parameter must be set to **on** in order for Omnii to recognize the device connected to the Port Replicator 9-pin (COM5).

Power (COM6 only)

Pin 9 on Omnii COM6 is reserved for 5V power out and is defaulted to OFF. This parameter must be set to **on** to enable power to a Snap Module or Vehicle cradle.

Baud

Double-tapping on this parameter displays a pop-up window in which you can choose an appropriate rate of data transfer.

Figure 4-1 Port Baud Rates

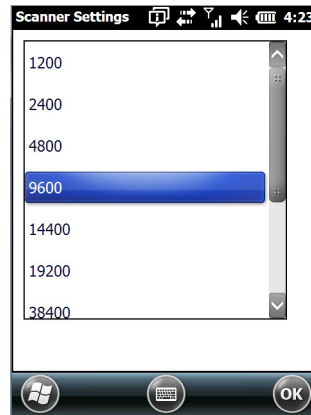

Data Bits

This parameter determines the number of data bits included in each asynchronous data byte. Most devices use 8-bit data bytes. Double-tapping on this option displays a pop-up window in which you can choose either 7 or 8 data bits.

Parity

This parameter determines the type of parity checking used on the data going through the port replicator port. Double-tapping on this option displays a pop-up window in which you can choose the appropriate parity.

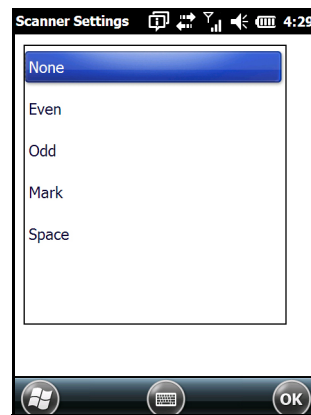

Stop Bits

This parameter specifies the number of stop bits — 1, 1.5 or 2 — used for asynchronous communication.

Trigger On Sequence and Trigger Off Sequence

If a SICK scanner connected to an Omnii port requires a serial stream of data bytes to trigger the scanner on and another to trigger the scanner off, the Trigger On Sequence and Trigger Off Sequence parameters allow you to define these serial streams.

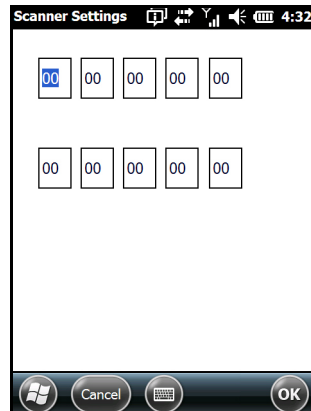

Double-tapping on Trigger On Sequence or Trigger Off Sequence displays a screen with a hex array of 10 elements.

These parameters work in conjunction with Manage Triggers sending on and off data streams to the trigger module you assigned. For example, suppose you launch Manage Triggers and choose Decoded Scanner as the 'module to trigger'. Next, you assign a 'trigger key' — for this example, . (period). To define the serial stream of data bytes to control the on and off function of the 'trigger key', enter a hex value in the Trigger On Sequence and the Trigger Off Sequence fields. When you press the trigger key, the Trigger On Sequence is sent and when you release the trigger key, the Trigger Off Sequence is sent, turning the trigger key on and off.

Screen

- Tap **Start>Settings**. Tap on the **System** icon, and then tap on the **Screen** icon.

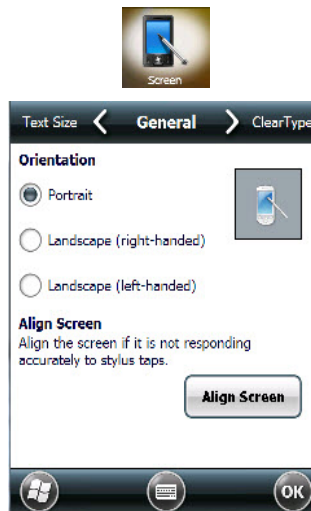

This icon allows you to align (calibrate) your touchscreen, turn ClearType on and off and adjust the size of the text displayed on the Omnii screen.



IMPORTANT

Refer to [“Calibrating the Touchscreen”](#) on page 2-13.

Screen Rotation

- Tap **Start>Settings**. Tap on the **System** icon, and then tap on the **Screen Rotation** icon.

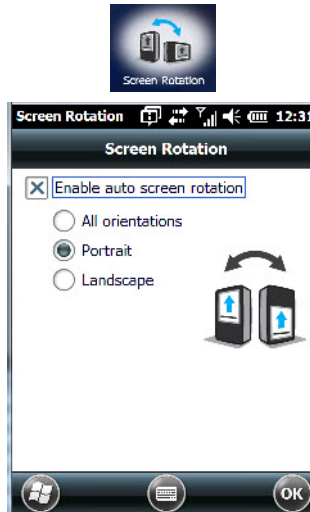

This screen allows you to determine how your Omnii screen will behave depending on how the unit is rotated.

All orientations: screen rotates to portrait or landscape to match the orientation of the actual Omnii.

Portrait: screen only rotates between the two portrait orientations – right side up and up side down.

Landscape: screen only rotates between the two landscape orientations – left side up and left side down.

Enable auto screen rotation is enabled by default. If this option is disabled, you can determine screen orientation manually.

Manual Screen Orientation

If you prefer to set screen rotation manually:

- Disable the **Enable auto screen rotation** option.

A **Configure** button is displayed on the screen.

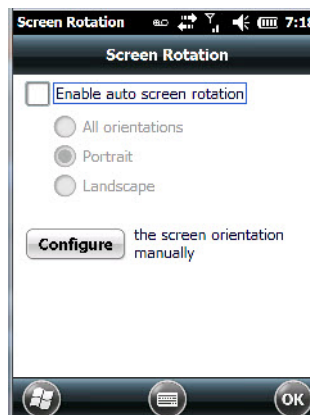

Tapping on the **Configure** button displays the Screen dialog box.

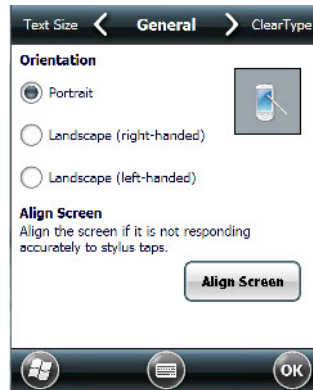

IMPORTANT Refer to “Screen” on page 4-95 for details about this screen.

System Properties

This program identifies the computer software and hardware components, indicating which components are installed, their identification, version or part numbers, and whether they are enabled or disabled.

- Tap on **Start>Settings>System**, and then tap on the **System Properties** icon.

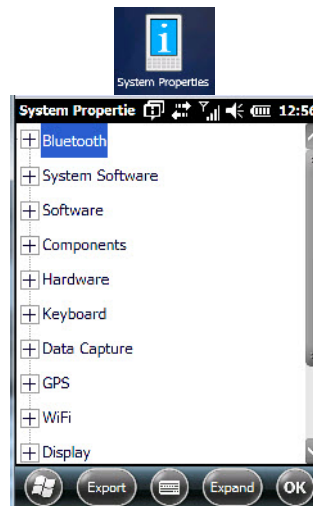

Tapping on the Export button creates a log (SystemProperties.xml) of your current components, which is placed in the My Devices folder in Windows Explorer.

Instead of expanding each section individually, you can also choose to open all the lists at once by tapping on the Expand button, which will then change to a Collapse button to enable you to collapse all the sections as well.

Task Manager

The Task Manager screen lists all running tasks (applications) or processes. This applet provides a number of options to manage these.

- Tap on **Start>Settings**. Tap on **System**, and then the **Task Manager** icon – the Task Manager screen is opened.

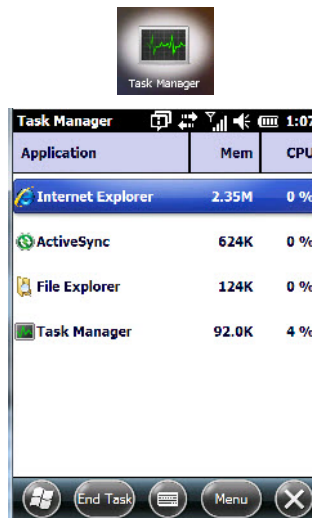

- **End Task:** To shut down an application, **highlight the program** in the list, and tap on the **End Task** softkey in the softkey bar at the bottom of the screen.

Task Manager Menu

The Task Manager menu provides additional options to help you manage your applications.

- Tap on the **Menu** softkey at the bottom of the screen.

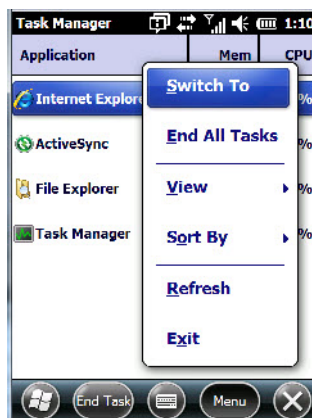

- **Switch To:** Makes the highlighted application active.
- **End All Tasks:** Shuts down all applications listed.
- **View:** Allows you to list either all running applications or all processes.
- **Sort By:** Allows you to sort active applications or processes based on Memory size, CPU or application or process Name.
- **Refresh:** Updates the list of applications or processes.
- **Exit:** Closes the Task Manager.

Total Recall

Total Recall is a Zebra utility developed to maintain applications and settings during a cold boot, as well as clone settings to other devices. This utility creates a restore point of a device at a known state. This can be used as a backup of the device (the administrator can clean the terminal and restore the profile at any time), or

a clone (the administrator can store different configurations for different uses to clone to other hand-held computers).



NOTE Total Recall works differently (e.g. restore on cold boot or on clean boot) on different OS platforms and versions (e.g. Windows CE 5.0, 6.0, Windows Mobile, Windows Embedded Hand-held). For detailed information and other updates on Total Recall information, please go to the Ingenuity Working website at:

www.ingenuityworking.com/knowledge/w/knowledgebase/total-recall.aspx

- Tap on **Start>Settings>System**. Tap on the **Total Recall** icon.

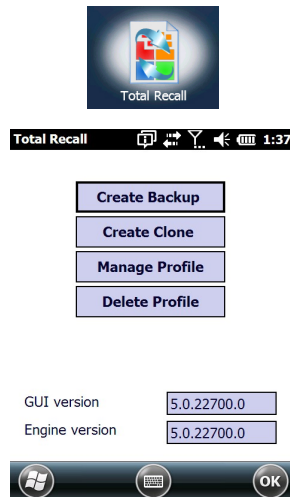

In the start up screen, you can choose from four options: Create Backup, Create Clone, Manage Profile, and Delete Profile.

Creating a Backup

- Tap on the **Create Backup** button to begin the process.

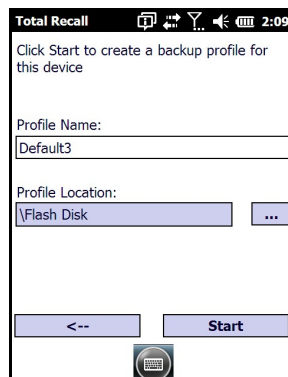

This dialog box displays the Profile Name and the storage destination for the profile file.

- In the Profile Name field, type a name for a profile.
- If you want to choose another location for your backup file (optional), tap on the [...] button to the right of the Profile Location field and choose one of a number of folders.



IMPORTANT Any profile not stored in persistent memory (Flash Disk, external USB drive) will be erased during a clean boot; therefore, you should store profiles on a persistent drive.

IMPORTANT When performing an autorestore, the program only searches for the profile located in the \Flash Disk\TotalRecall folder. If you store your profile anywhere else it will not be restored. Only one profile can reside in that folder.

- Tap on **Start**. A backup of the current settings will be created and saved to the specified location. The unit will then reboot.

To view profiles and choose restore options, refer to [“Managing Profiles” on page 4-101](#).

Creating a Clone

Cloning allows you to copy settings or configurations from one computer to another. There are two types of clones to choose from: a Full Clone and a Settings Only Clone.

A Full Clone contains all files, most of the registry, and the settings files.



IMPORTANT The target device for a Full Clone **MUST** have the same model type and OS build as the source, otherwise problems can occur. For example, if the target device has a newer build of the OS, the new build may have a different set of registry keys that may conflict with the source.

A Settings Only Clone can be copied to a wider array of devices, but it should not be used as an autorestore profile.

- Tap on the **Create Clone** button to begin the process. Your Omnii model type and OS will be identified in the cloning statement to ensure that you target devices of the same type.
- Give the clone profile a name and location.

- Tap on **Next**.
- In the next screen, choose **All** for a Full Clone, or **Selected Options** for a Settings Only Clone. If you choose Selected Options, a menu will open to enable you to decide which options you want cloned.

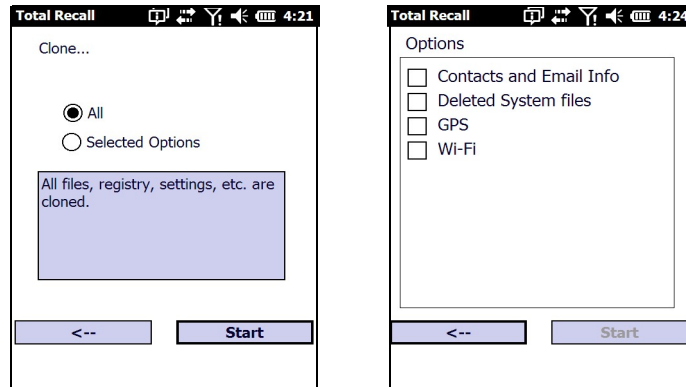

Managing Profiles

You can view profiles and choose profile options from the menus in this section.

Viewing a Profile

- Tap on the **Manage Profile** button to see your list of profiles. Highlight a profile, and then you can choose to **View** the Profile Summary and go on to the next menu, Profile Details.

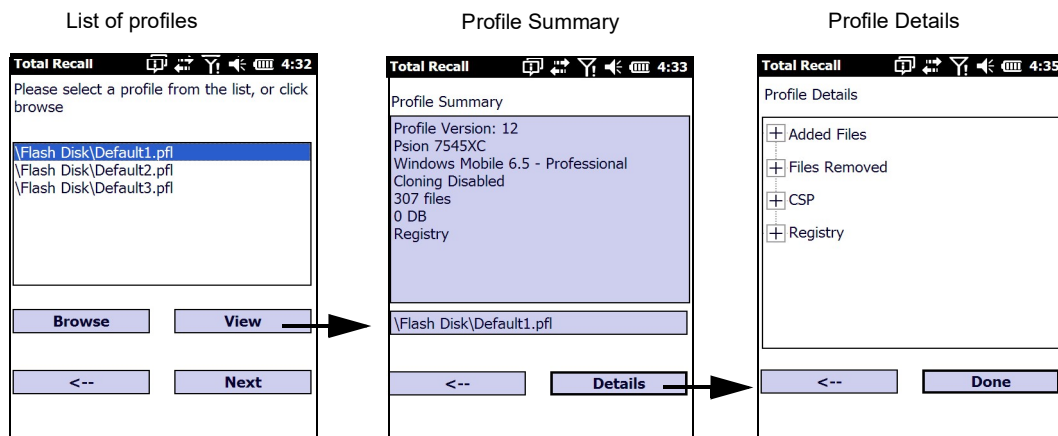

Profile Options

- Tap on the **Manage Profile** button to see your list of profiles, as shown above. Highlight a profile, and tap on the **Next** button to choose from options to restore or clone the profile. You can choose from four profile options: Restore Now, Set for Autorestore, Upload to A.R.C., and Clone to USB.



- Next, tap on the option button you want to use:
- Restore Now – restores the profile immediately. If you are restoring a profile that is a backup or Full Clone, the computer will clean reset first; if the profile is a Settings Only Clone, it will not.
- Set for AutoRestore – creates a profile that is automatically restored following a cold reset or a clean start. The profile is stored in the \Flash Disk\TotalRecall folder.

**IMPORTANT**

After setting an autorestore profile, that profile will overwrite any other profile already placed in the \Flash Disk\TotalRecall folder.

In an autorestore, Total Recall only restores the profile located in the \Flash Disk\TotalRecall folder. If you store your profile anywhere else it will not be restored.

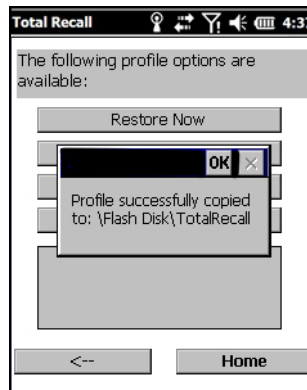

- Upload to A.R.C – uploads the profile to the Active Remote Configuration server. After you tap on **Send**, a message will come up either confirming that the upload was complete or that the connection to the server failed.

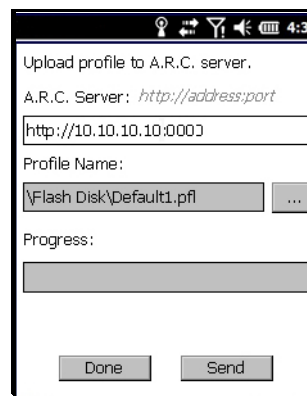

- Clone to USB – writes a clone of the profile to the USB drive. After you tap on the button, a message will come up either confirming that the USB drive is ready for deployment, or that it is not available.
- When you are ready to install the profile on another unit, turn on the next computer to be cloned and insert the USB key. The profile will be automatically installed to the computer's \Flash Disk\TotalRecall folder. There is a short delay in deployment so that you can cancel the process if needed.

USB drive prepared for cloning

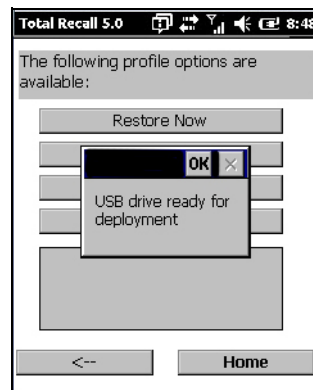

Autorun installation on next Omnii

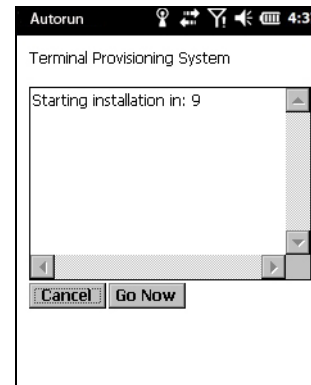

Deleting a Profile

- In the Total Recall home screen, tap on **Delete Profile**.

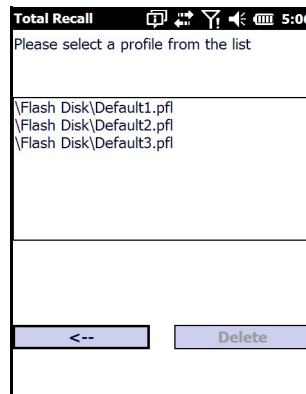

- Highlight the backup you want to delete, and tap on the [-->](Next) button.

A warning pop-up screen appears asking if you're certain that you want to delete this file.

- Tap on the **Yes** to delete the file.

TweakIT

- Tap on **Start>Settings>System**.
- Tap on the **TweakIT Settings** icon.

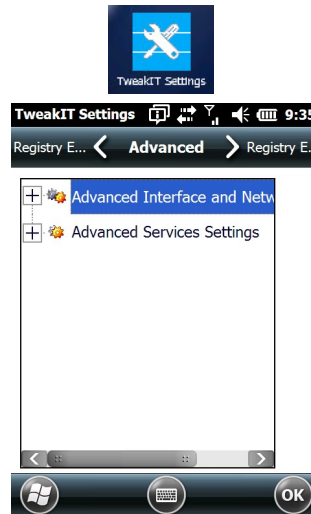

This utility allows you to 'tweak' or adjust system settings such as the interface, network and servers.

Advanced Interface and Network Settings

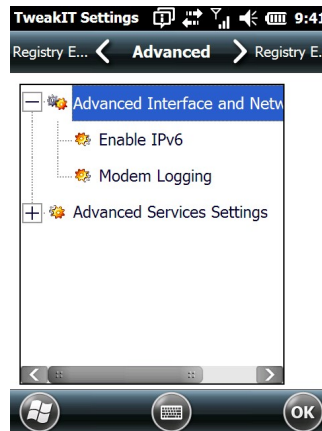

Enable IPv6

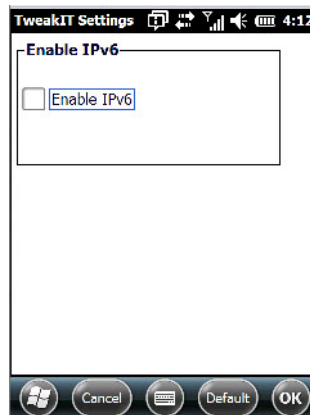

This option allows you to enable Internet Protocol, version 6, that has been published to use 128-bit IP address (replacing version 4).

Modem Logging

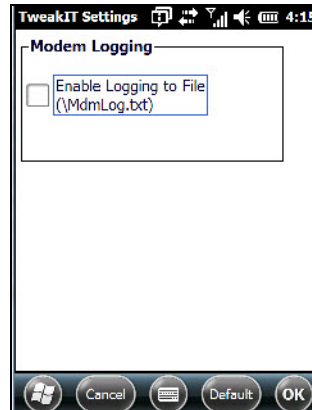

When this option is enabled, the Omnii logs AT commands (e.g., dial-out information, password string, etc.) that the administrator can monitor for debugging purposes. Modem commands are stored in: \MdmLog.txt.

Advanced Services Settings

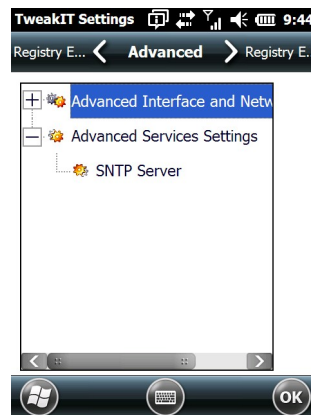

SNTP (Simple Network Time Protocol) Server

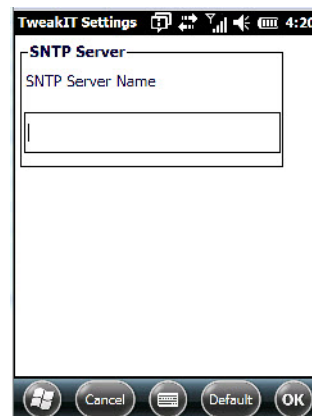

The SNTP Server Name typed in this dialog box is used to synchronize Omnii time with that of the time server. A warm reset must be performed once the server name has been entered.

Registry Editor

This option is reserved for senior administrators who have a strong understanding of registry keys and values. Careless registry editing can cause irreversible damage to the Omnii.

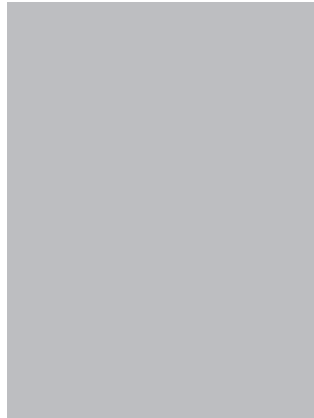

CHAPTER 5 ACCESSORIES

Pistol Grips	5-3
Removing the Trigger Cover	5-3
Attaching the Pistol Grip.	5-3
Carrying and Protective Accessories	5-4
The Hand Strap - Model ST6025	5-5
Protective Carrying Case - Model ST6090.	5-5
Hard Shell Holster - Model ST6055	5-5
Power Accessories	5-6
Snap Modules	5-6
AC Wall Adaptor - Models ST1050 and ST1050-AR	5-8
Vehicle Power Outlet Adaptor - Model ST3113	5-8
Chargers and Docking Stations: General Information	5-9
Important Charger Safety Instructions	5-9
Charging the Battery.	5-9
Installation — Chargers and Docking Stations	5-10
Operator Controls	5-10
Power Consumption Considerations	5-10
Desktop Docking Stations - Models ST4002 and ST4003	5-10
Charging a Battery Installed in Omnii	5-12
Indicators	5-13
Operation	5-13
Charging the Omnii Battery	5-13
Charging the Spare Battery	5-13
Cleaning the Desktop Docking Station	5-13
Troubleshooting	5-14
Docking station does not seem to power on.. . . .	5-14
Omnii charge indicator LED stays off.	5-14
Omnii charge indicator LED is red.	5-14
Spare battery LED is red with a battery installed.	5-14
Spare battery LED does not turn on when a battery is installed.	5-14

Quad Docking Station – Model No. ST40045-15
Operator Controls5-15
Indicators5-16
Quad Docking Station Operation5-16
Charging the Omnii Battery5-16
Installation5-16
Connecting to the Ethernet Network.5-17
Cleaning the ST4004.5-17
Troubleshooting.5-18
Omnii Charge Indicator LED Stays Off5-18
Power LED Does Not Light Up.5-18
Omnii Charge LED Flashes Yellow5-18
Omnii Charge Indicator LED is Red5-18
Powered Adaptor LED Stays Off.5-18
Vehicle Cradles - Models ST1000 and ST10025-18
Vehicle Cradle Mounting Recommendations5-19
Insertion and Removal of Omnii5-21
Maintaining the Vehicle Cradle5-22
ST1002 Powered Cradle Installation5-22
Wiring Guidelines5-23
Installation in High Voltage Vehicles.5-23
Extreme Wet Environments5-24
Wiring Vehicle Power and Communications to the Cradle.5-24
Battery Charger (6-Slot) - Model ST30065-26
Installation.5-26
Operator Controls5-27
Charge Indicators.5-27
Charging Batteries5-27
Troubleshooting.5-28
Improper Battery Storage5-28
Power Self-test LEDs Don't Light Up5-28
Indicator Does Not Light When Battery Installed5-28

Pistol Grips

There are a number of pistol grips available to you depending on the type of back cover and scanner/imager installed in your hand-held. Refer to the table following for a list of pistol grip model numbers and the types of back covers and scanners/imagers with which they are compatible.

Pistol Grip Description	Model Number
Pistol Grip Standard Pod Kit	ST6000
Pistol Grip Standard Back A Kit	ST6100
Pistol Grip Standard Back B Kit	ST6400
Pistol Grip Freezer Standard Back Kit	ST6500

Removing the Trigger Cover

Before installing the pistol grip, you need to remove the trigger cover.

Using a flathead screwdriver, gently and carefully pry the trigger cover off the hand-held.

Figure 5-1 *Removing the Trigger Cover*

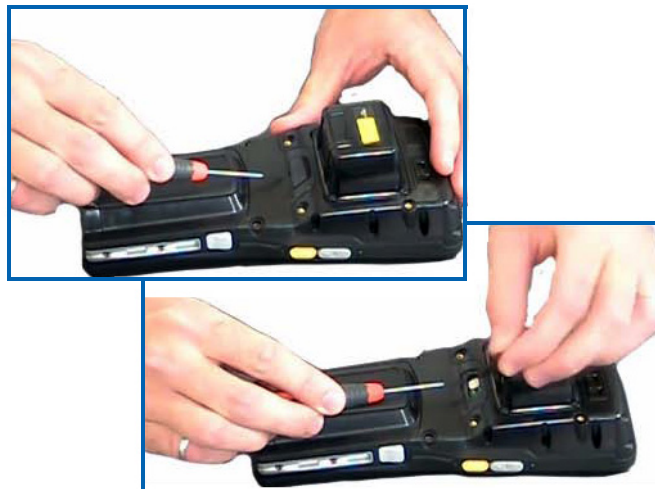

Attaching the Pistol Grip



NOTE Prior to installation, make sure the trigger mechanism is securely snapped into the pistol grip body and that the trigger operates properly.

The pistol grip is attached to the back of Omnii using the four threaded inserts in the upper part of the Omnii casing (see [Figure 5-2 Attaching the Pistol Grip](#)). Four M3x6 Phillips head screws are provided.

- Position the pistol grip so that it fits snugly over the back of the unit and the holes in the pistol grip are aligned with the threaded inserts on the back of the hand-held.
- Using a Phillips screwdriver, tighten the screws to a torque of 3 lbs-in (3kgf-cm) to secure the pistol grip in place.

Figure 5-2 Attaching the Pistol Grip



Carrying and Protective Accessories



NOTE Omnii Hand-Held Computer is a body worn device, and to maintain compliance with the FCC RF exposure guidelines, use a Zebra approved carrying case. Use of non-approved accessories may violate FCC RF exposure guidelines.

There are several Omnii carrying and protective accessories to help you work safely and comfortably.

Attaching Carrying Accessories

If your Omnii is not fitted with a hand strap, you can install it using the carrying accessory kit supplied. You'll need:

- A Phillips head screwdriver.



IMPORTANT Do not use adhesives such as Loctite to secure screws on carrying accessories. These chemicals may damage the plastic casing.

Accessory	Model Number
Wrist Strap	ST6040
Hand Strap	ST6025
Soft Shell Holster	ST6050
Hard Shell Holster	ST6055
Forklift Holster	ST6051
Carrying Case	ST6090
Pouch	ST6091

Accessory	Model Number
Screen Protector	RV6105
Rubber Boot:	
Yellow – Standard back covers A & B	ST6080
Grey – Standard back covers A & B	ST6081
Yellow – Expansion Back Covers	ST6082
Grey – Expansion Back Covers	ST6083
Yellow – Expansion Back Covers, WWAN	ST6084
End-cap	ST6085
Grey – Expansion Back Covers, WWAN	ST6086
End-cap	
Blue - Freezer Standard Back Covers	

The Hand Strap - Model ST6025

- Attach the strap to the two threaded inserts located at the back of the hand-held near the top of the unit (see [Figure 5-3 Attaching the hand strap](#)), using the two Phillips head screws provided with this accessory.
- Stretch the handstrap toward the base of the hand-held, and hook the clip at the bottom of the handstrap into the slot near the base of the battery pack.

Figure 5-3 Attaching the hand strap

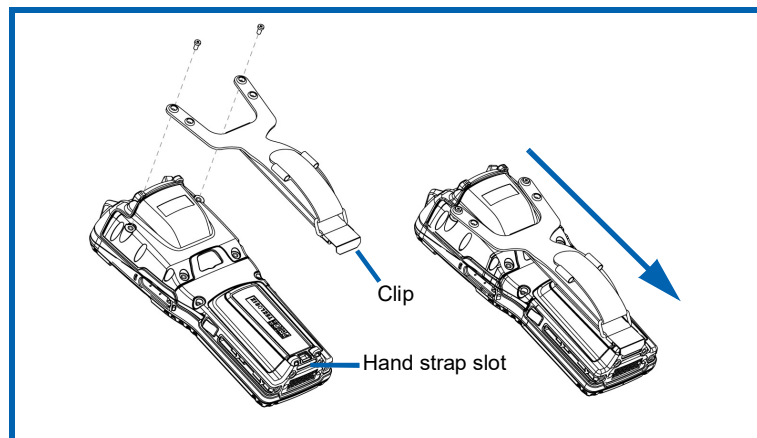

Protective Carrying Case - Model ST6090

A carrying case is available for Omnia to shield the unit from damage. It is compatible with the hand strap. A variety of cases are available, depending on the type of end-cap attached to your unit.

Hard Shell Holster - Model ST6055

A hard shell holster that includes a belt, leg tie-down, and tether, can be used to hang Omnia with a pistol grip from your waist. Note that holsters are designed for both right- and left-handed use.

- Feed the belt through the top panel of the holster, and adjust the belt as needed.
- If using the leg tie-down strap, wrap it around your leg and snap the buckle closed. Adjust the tightness of the strap for security and comfort.

- Place Omnii into the holster with the grip extending back through the custom opening.
- If desired, attach the tether to the pistol grip.

Figure 5-4 Hard Shell Holster (pistol grip tether not shown)



Power Accessories

The following accessories can be ordered for your Omnii:

Description	Model Number
AC Wall Adaptor	ST1050 or ST1050-AR
Vehicle Power Outlet Adaptor	ST3113
Snap Module – Charger Only	ST4000
Snap Module – USB Host/Client plus Charger	ST4001
Snap Module – DE9M powered serial plus Charger	ST4005

Snap Modules

i **NOTE** The Snap Modules are shipped with their own quick start guide (Omnii Snap Modules Quick Start Guide, PN 8000220). The guide should be reviewed for additional information and updates.

Snap Modules are mobile power chargers for Omnii. They are compatible with the AC wall adaptor (Model ST1050 or ST1050-AR) and the Vehicle Power Outlet Adaptor (Model ST3113).

Three types of Snap Modules are available:

- **Model ST4000** (Charger only variant): powers and charges the hand-held.
- **Model ST4001** (USB variant): powers and charges the hand-held. It provides communications via USB 1.1/2.0 Host and USB 2.0 Client connectors and provides a DC IN port. When attached to Omnii, it allows ActiveSync or Windows Mobile Device Center connectivity with your PC, and the use of a USB device such as a USB memory key or supported peripheral.

- Model ST4005 (Serial variant):** provides a powered DE9M serial connector. It powers and charges Omnii, and provides serial communications to tethered devices. The DE9M connector is capable of speeds up to 115,200 bps. Pin 9 is reserved for 5V power out and is defaulted to **off**. To enable power to this port, in your Omnii desktop, go to Start>Settings>System>Scanners, which opens the Scanner Settings menus. In the Ports menu, select **on** for the Power parameter under the COM6 port.

Figure 5-5 Snap Module Ports

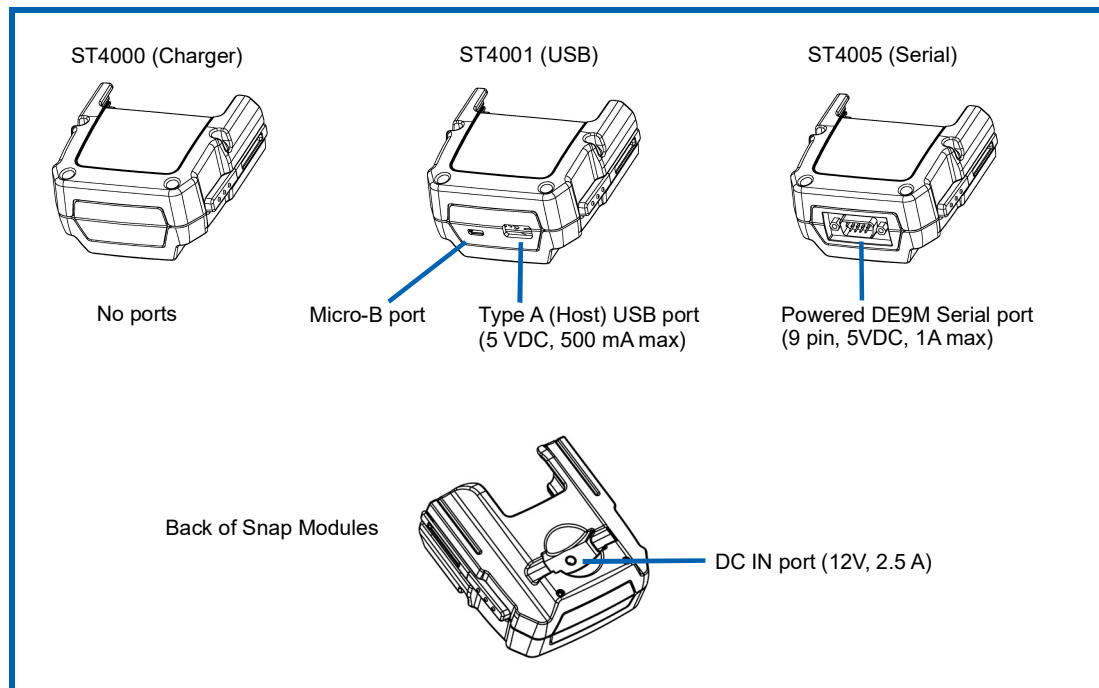
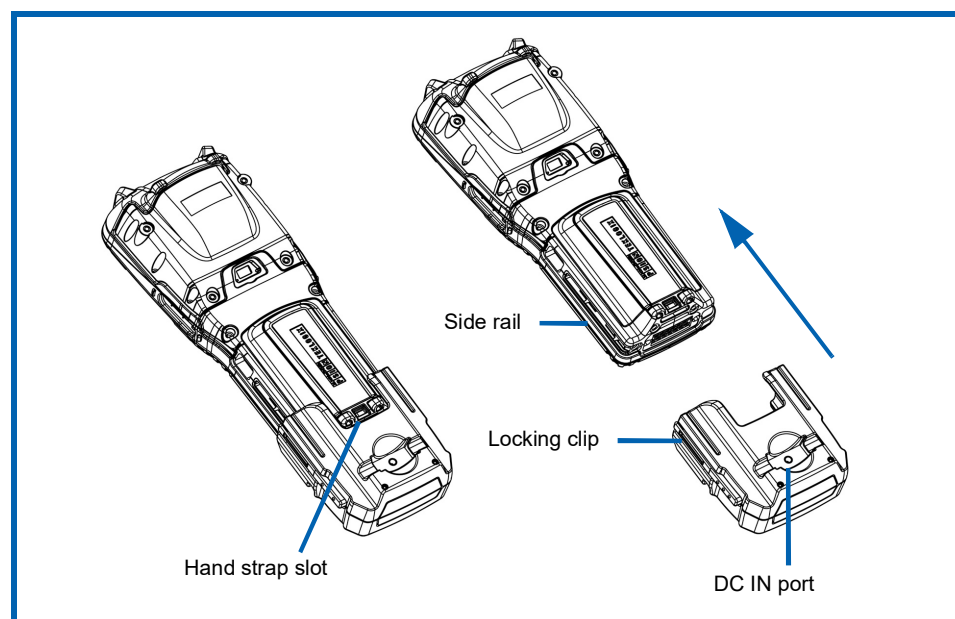

Figure 5-6 Snap Module Installation



To attach the Snap Module charger to Omnii:

- Make sure that the charger connector and Omnii docking connector are free of dust or any other debris before connecting them.
- A slot in the side rail on each side of the hand-held accommodates the locking clips of the charger. To attach the charger, align it with the base of the hand-held and gently slide up until the locking clips snap into place (Refer to [Figure 5-6 Snap Module Installation](#) on page 5-7).
- To remove the charger, press down on the base of the clip arms to release them from the Omnii side rails and slide the adaptor off.
- Connect the charger to an AC or DC power source using the appropriate regional plug or cable. Then connect the charger's DC plug into the Snap Module's DC jack. You can also attach an ST4001 or ST4005 Snap Module to the Omnii and use the Omnii battery to power USB or serial peripherals, for enhanced mobility.



NOTE If you are using a hand strap, there is no need to remove it before installing the Snap Module, since the Omnii hand strap slot will still be accessible.

AC Wall Adaptor - Models ST1050 and ST1050-AR

The AC wall adaptor available for your docking station or Snap Module allows you to operate your hand-held using AC power while charging the battery inserted in the unit.

The ST1050 is shipped with adaptor plugs suitable for use in the following regions: United Kingdom, Australia, Europe and North America.

- Choose the adaptor plug that is suitable for use in your country. Slide the adaptor plug into the Universal AC power supply, snapping it into place. These two pieces, coupled together, are referred to as an AC wall adaptor.
- Insert the DC plug into the docking station or Snap Module jack.
- Plug the pronged end into an AC outlet.

Figure 5-7 ST1050 AC Wall Adaptor and plugs

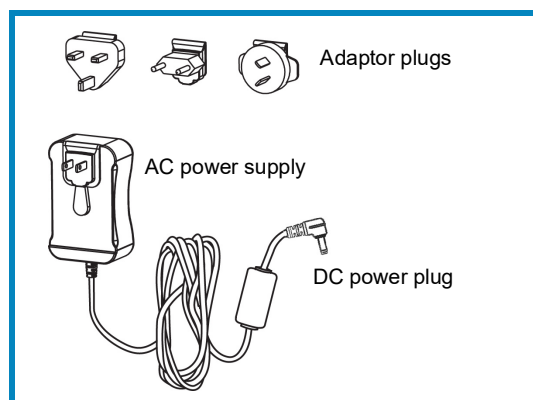

The ST1050-AR wall adapter is kitted with an AC plug that is suitable for use in Argentina.

Vehicle Power Outlet Adaptor - Model ST3113

The Vehicle Power Outlet Adaptor allows you to power your hand-held and recharge your battery using power drawn from your vehicle's automotive power outlet when used in conjunction with a Snap Module.

Figure 5-8 ST3113 Vehicle Power Outlet Adaptor



- Attach a Snap Module to the base of the hand-held. Refer to “[Snap Modules](#)” on page 5-6 if you require further details.
- Insert the DC power plug on the Vehicle Power Outlet Adaptor into the DC IN port on the Snap Module.
- Insert the Vehicle Power Outlet Adaptor plug into automotive power outlet in your vehicle.



NOTE Battery charging continues whether the hand-held is switched on or off.

Chargers and Docking Stations: General Information

Important Charger Safety Instructions



IMPORTANT

Before charging a battery with a desktop docking station, it is critical that you review the safety guidelines in the Omnii Hand-Held Computer Regulatory & Warranty Guide (PN 8000191) and the Omnii Hand-Held Accessories Regulatory & Warranty Guide (PN 8000205).

Charging the Battery

Omnii Hand-Held Computer operates with lithium-ion battery pack Model ST3001. Preparing the unit for operation requires that the battery pack be charged and installed in the hand-held.

Batteries shipped from the factory are charged to approximately 40% of capacity. Lithium-ion battery packs must be fully charged before use. These batteries can be charged with a variety of chargers and docking stations. Currently the following are available:

- The Snap Module is a mobile adaptor for Omnii. Three models are available — see “[Snap Modules](#)” on page 5-6.
- The AC Wall Adaptor operates as an AC power source and also charges the battery installed in the unit — see “[AC Wall Adaptor - Models ST1050 and ST1050-AR](#)” on page 5-8.
- The Vehicle Power Outlet Adaptor powers Omnii and recharges the battery using power drawn from your vehicle’s automotive power outlet — see “[Vehicle Power Outlet Adaptor - Model ST3113](#)” on page 5-8.
- The Desktop Docking Stations operate as both chargers and docking stations. Operating as a charger, both the battery installed in Omnii and a spare battery can be charged. Priority is given to charging the hand-held’s battery. See “[Desktop Docking Stations - Models ST4002 and ST4003](#)” on page 5-10.

Normally it takes 3 to 4 hours to charge a battery. The Omnii intelligent charging system protects the battery from over-charging by terminating the charge process when the battery is at maximum capacity.

% Charge Completed	During Sleep Mode	While Operating
100%	4 hrs.	8 hrs.
75%	2 hrs.	6 hrs.



IMPORTANT

To avoid damaging the battery, chargers will not begin the charge process until the battery temperature is between 0°C to 40°C (32°F to 104°F).

Installation — Chargers and Docking Stations

When installing a charger or docking station, consider the following guidelines.

- Keep chargers and docking stations away from excessive dirt, dust, water and other liquids, and contaminants.
- Chargers will not charge batteries outside an ambient temperature range of 0°C to 40°C (32°F to 104°F). It is recommended that the charger or docking station be operated at room temperature — between 18°C and 25°C (64°F to 77°F) for maximum performance.

After unpacking your unit:

- Visually inspect the charger for possible damage.
- Install the IEC power cord (if applicable) and apply power.

Operator Controls

Omnii docking stations and chargers have no operator controls.

Power Consumption Considerations

Check to ensure the mains circuit supplying chargers and/or docking stations is adequate for the load, especially if several chargers and docking stations are being powered from the same circuit.

Desktop Docking Stations - Models ST4002 and ST4003



NOTE Specialized versions of the desktop docking station are available for Argentina and Korea. For Argentina, model number ST4002-AR is packaged with a wall adaptor and a suitable, regional AR plug. For Korea, model number ST4002-KR is packaged with a wall adaptor and a KR plug.



IMPORTANT

The desktop docking station is shipped with its own quick start guide (ST4002 and ST4003 Desktop Docking Stations Quick Start Guide, PN 8000203). It is critical that it be reviewed for additional information and updates.

Omnii can be inserted into two desktop docking stations which are designed to charge the battery installed in the hand-held along with a spare battery pack: Models ST4002 and ST4003.



IMPORTANT These docking stations can only be used to charge Zebra approved lithium-ion batteries.

The ST4002 and ST4003 desktop docking stations feature:

- Fast charging of the internal battery.
- Fast charging of the spare battery pack.
- A Host USB port to connect peripherals such as a printer, keyboard, etc.
- A Client USB port to connect the docking station to a PC.



NOTE The ST4002 desktop dock can be upgraded to include the DE9M and RJ45 interfaces by using the ST4100 Xmod (Expansion Module).

The ST4003 desktop docking station additionally provides:

- A DE9M serial port (unpowered) and an RJ45 10Base-T Ethernet interface. Both these interfaces are compatible with the USB to Ethernet/serial drivers included in Omnii (see [Figure 5-10 Back of ST4003 Desktop Docking Station](#) on page 5-12).

Figure 5-9 Desktop Docking Station - Models ST4002 and ST4003



The desktop docking station storage temperature is -30°C to $+60^{\circ}\text{C}$ (-22°F to 140°F). Operating temperature and humidity are: 5 - 95% non-condensing and 0°C to 40°C (32°F to 104°F).

The desktop docking station uses careful charge algorithms designed to maximize battery life while ensuring the shortest possible charge time. See ["Battery Details" on page 2-5](#) for more information regarding battery capacity, charge times and battery life. See ["Charging the Battery" on page 5-9](#) for spare battery charge information.

Figure 5-10 Back of ST4003 Desktop Docking Station

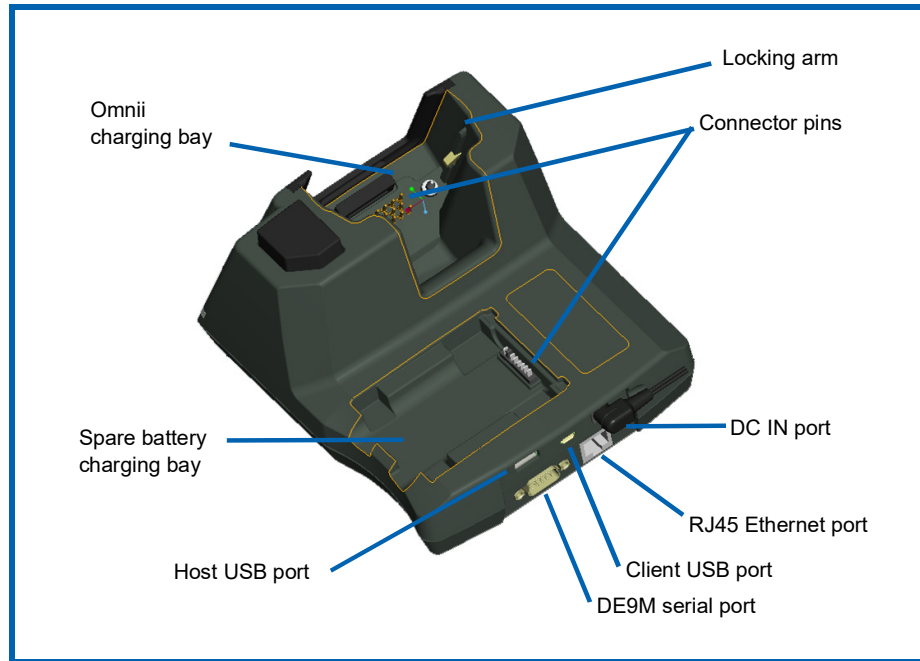

Charging a Battery Installed in Omnii

- Insert the DC power cable to the DC IN port on the desktop docking station. Plug the pronged end of the cable into an AC outlet.
- Slide the hand-held into the docking station, making certain that the hand-held is securely seated on the docking station connector pins and engages the locking arms of the docking station. When the Omnii is switched on, a message is displayed briefly on the screen indicating that the unit is properly installed in the station and the docking station icon is displayed in the taskbar.



The LED on Omnii lights up indicating that the unit has external power and battery charging will begin. It is safe to leave the unit in the desktop docking station while it is not in use — the battery will not be overcharged.

Indicators

The front-mounted LED on the desktop docking station indicates the spare battery charge status. The LED on Omnii is active even when the hand-held is inserted in a docking station (and in suspend mode) so that the charge status of the battery can be detected easily.

Charge LED Behaviour	Function
OFF	No battery detected.
Solid Green	Battery charging complete.
Flashing Green	Charge in progress.
Flashing Yellow	Battery is not charging due to out-of-temperature conditions.
Solid Red	A charging timeout, unable to read battery, or non Zebra battery.

Operation

Charging the Omnii Battery

The desktop docking station supplies DC power to enable the Omnii internal fast charger.

When installed in the dock, the Omnii battery charge LED will illuminate to indicate the unit has external power and can charge the internal battery. Omnii charge indication follows the same convention as the charger's spare battery indicator ([Figure 5-9 Desktop Docking Station - Models ST4002 and ST4003 on page 5-11](#)).



NOTE Battery charging continues whether Omnii is switched on or off.

Charging the Spare Battery



IMPORTANT Do not store spare batteries in a charger for more than 72 hours. Doing so may damage the battery or reduce its charge capacity.

- Install the battery in the battery charging bay (rear slot of the desktop docking station). Place the battery contacts down to mate with the connector, and pivot the battery into place in the battery charging bay.
- The desktop docking station spare battery LED lights up immediately. During charge the LED will be flashing green.
- When the battery has finished charging, the LED turns solid green.
- The charge stops when the battery is fully charged and the LED remains green.

A full charge will take 3 to 4 hours for a 5000 mAh battery. This may take up to 8 hours if the hand-held is also docked and charging.

Cleaning the Desktop Docking Station



IMPORTANT Do not immerse the unit in water. Dampen a soft cloth with mild detergent to wipe the unit clean.

- Use only mild detergent or soapy water on a slightly damp cloth to clean the desktop docking station. Avoid abrasive cleaners, solvents or strong chemicals for cleaning. The plastic case is susceptible to harsh chemicals. The plastic is partially soluble in oils, mineral spirits and gasoline. The plastic slowly decomposes in strong alkaline solutions.

Troubleshooting

The indicators, applications, and drivers required to use and monitor the desktop docking station as a dock (as opposed to a charger) are installed on Omnii — no applications are present on the docking station itself.

Docking station does not seem to power on.

- When first connected to the DC power supply, the charger LED should flash a sequence of red, yellow, and green.
- If not, the charger is defective and requires service.

Omnii charge indicator LED stays off.

When Omnii is docked into a powered desktop docking station and the Omnii charge indicator LED stays off, there could be a problem with the hand-held or with the docking station. Use a hand-held with a properly functioning charge indicator to isolate the problem.



NOTE The desktop docking station charge LED only shows the status of the spare battery.

Omnii charge indicator LED is red.

If the Omnii charge indicator is red when the hand-held is docked:

- Remove Omnii and disconnect the adaptor DC power cable.
- Wait at least 20 seconds, and then plug the cable in again.
- If the Omnii indicator still shows a fault, the hand-held requires service.

Spare battery LED is red with a battery installed.

- Try inserting a battery that is known to be working with another charger.
- If the charge slot LED continues to show red with the known working battery, the charger is defective and requires service.
- Your Zebra battery and desktop docking station are carefully designed for safety and capacity performance. If the battery or charger are not Zebra approved products, or the safety mechanism is faulty, the spare charge slot LED or the Omnii LED will display red.

Spare battery LED does not turn on when a battery is installed.

- Inspect the charge slot contacts for damage (are they bent, flattened, twisted or broken?).
- Reinstall the battery and check that it is fully seated in the slot.
- Try inserting a battery that you know to be working into the charger slot.
- Disconnect and reconnect the DC adaptor, and check that the spare battery LED indicator flashes at power-up.
- If the charge slot fails to charge the known working battery, it is defective and requires service.

Quad Docking Station – Model No. ST4004



IMPORTANT

The quad docking station is shipped with its own quick start guide — Omnii ST4004 Quad Docking Station Quick Start Guide (PN 8000222). It is critical that it be reviewed for additional information and updates.



IMPORTANT

When ordering a charger, you must also order an IEC-320/IEC-60320 C13 power cord separately.

Figure 5-11 Front view

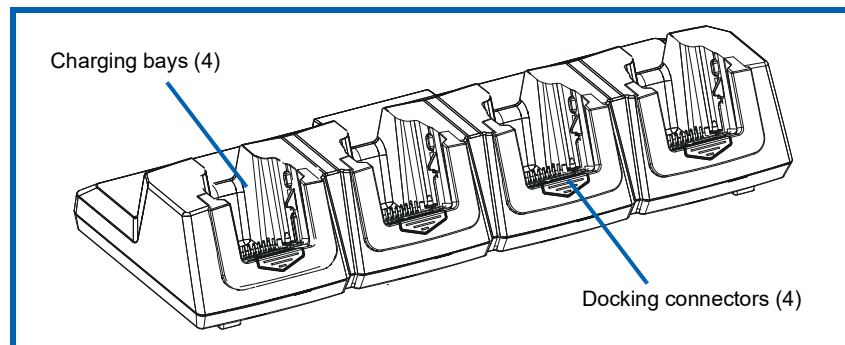
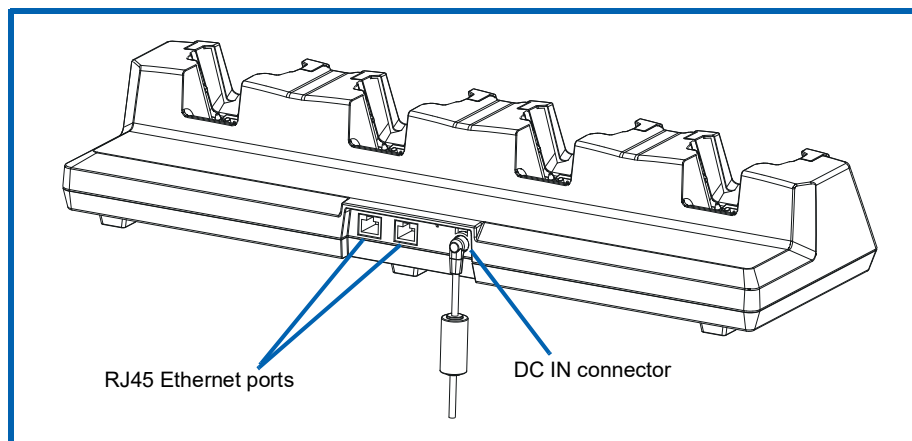

Figure 5-12 Rear view



The ST4004 Quad Docking Station is designed to accept up to four Omnii hand-held computers. The docking station powers the units and their internal battery charger. The docking station also connects up to four of the hand-held computers to a 10/100 Base-T Ethernet network and allows for Ethernet data transfer. An additional Ethernet interface is available for connecting more docking stations downstream, up to 4 on the same network.

Operator Controls

The ST4004 has no operator controls or power switch.

Indicators

The quad docking station is equipped with Ethernet activity and link LEDs (see [Figure 5-14 Ethernet network connection](#) on page 5-17).

Quad Docking Station Operation

Charging the Omnii Battery

- Insert the DC power plug into the ST4004 rear DC IN connector (see [Figure 5-14 Ethernet network connection](#) on page 5-17).



IMPORTANT Use IEC-320 C13 power cords approved by Zebra, with the ground pin connected to a proper earth-grounded receptacle. Check with a qualified electrician if you are uncertain of your receptacle grounding.

The ST4004 supplies DC power to enable the Omnii internal fast charger. Normally, a full charge of the battery will take from 3 to 4 hours.

- Insert up to four Omnii computers into the docking station charging bays, pressing down gently but firmly to seat them securely.
- During the charge, the Omnii LED slow flashes green.
- When the battery finishes charging, the LED turns solid green.
- To remove Omnii, push down on the release mechanism on the front face of the docking bay. The hand-held will detach from the docking bay release arms and can be pulled up and out.



NOTE Battery charging continues whether Omnii is switched on or off.

Figure 5-13 Insertion and removal of Omnii computers

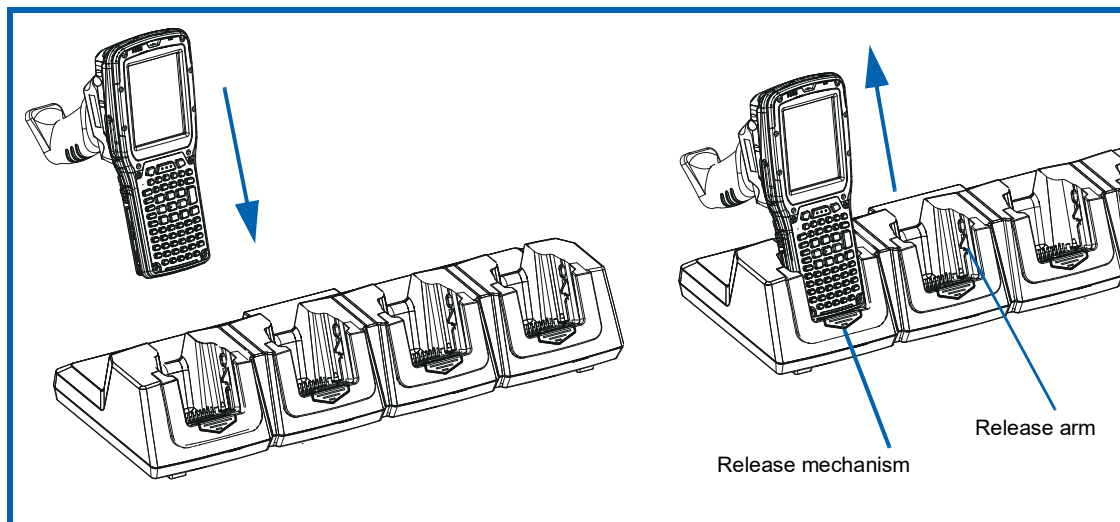

Installation

Place the charger in an area that is free from excessive dirt, dust, water and other liquids, and contaminants. The ambient temperature must be in the range 0° C and 40° C (32° F to 104° F). The docking station will not charge batteries outside of this temperature range. For maximum performance, it is recommended that the charger be operated at room temperature — a temperature range between 18°C to 25°C (64°F to 77°F).

Connecting to the Ethernet Network

Network Access

Omnii automatically detects insertion into the docking station and loads the appropriate drivers to communicate with the network. To connect more docking stations downstream (up to 4 on the same network), use the Ethernet cable supplied with your quad docking station as the daisy chain cable (see [Figure 5-15 Daisy chain configuration](#) on page 5-17).

Figure 5-14 Ethernet network connection

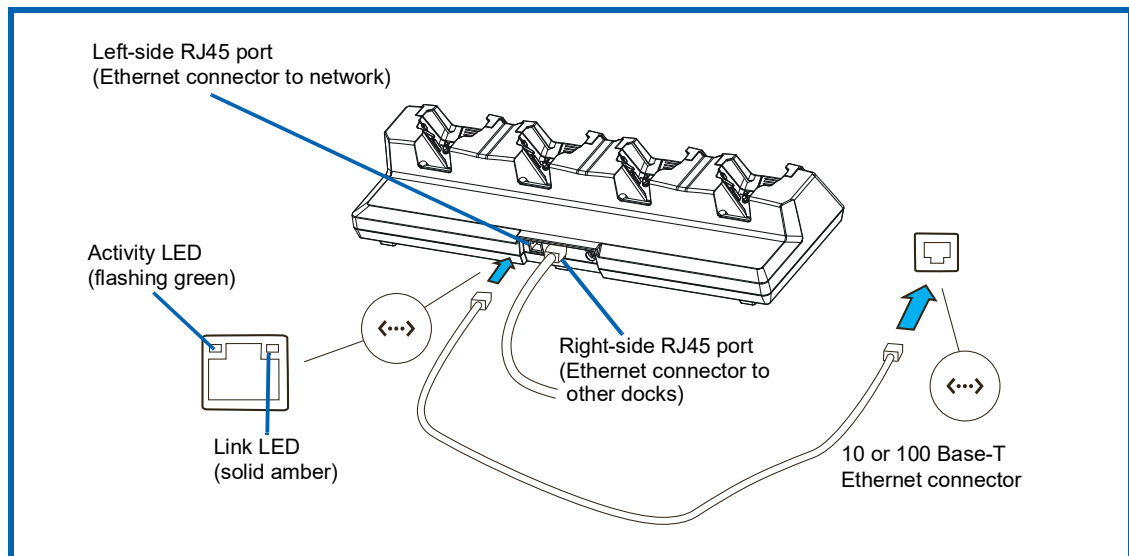
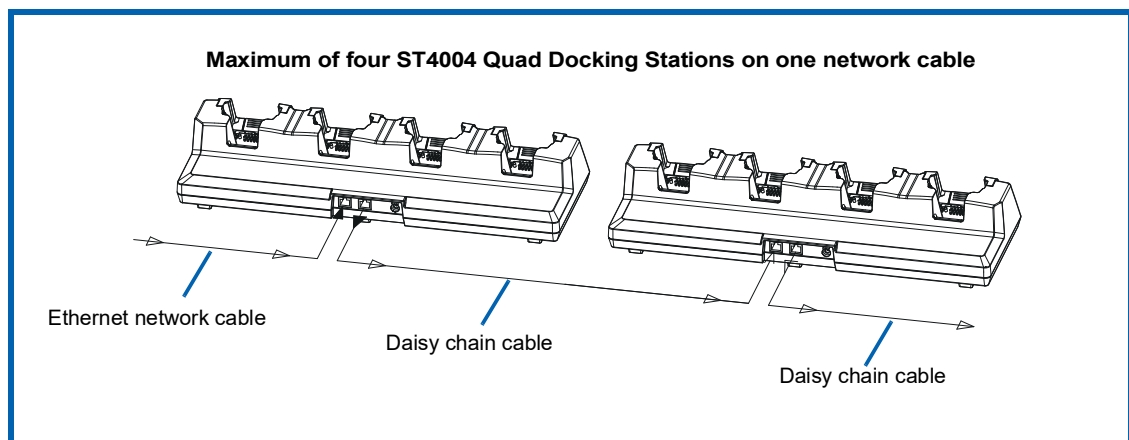

Figure 5-15 Daisy chain configuration



Cleaning the ST4004



IMPORTANT

Do not immerse the unit in water. Dampen a soft cloth with mild detergent to wipe the unit clean.

Use only mild detergent or soapy water on a slightly damp cloth to clean the ST4004. Avoid abrasive cleaners, solvents or strong chemicals for cleaning. The plastic case is susceptible to harsh chemicals. The plastic is partially soluble in oils, mineral spirits and gasoline. The plastic slowly decomposes in strong alkaline solutions.

Troubleshooting

Omnii Charge Indicator LED Stays Off

When Omnii is docked in a powered ST4004 and the hand-held's charge indicator LED stays off, there may be a problem with Omnii or with the docking station. Make sure a battery is installed in the Omnii, otherwise use an Omnii with a properly functioning charge indicator to isolate the problem.

Power LED Does Not Light Up

- Remove all Omnii units, and unplug the docking station.
- Connect another device to the mains outlet to ensure there is power.
- Remove the IEC mains power cable from the charger, and check it for damage.
- Reconnect the mains cable in the charger and mains outlet.

Omnii Charge LED Flashes Yellow

A flashing yellow Omnii charge LED (the left-most LED on the hand-held) indicates that the battery is not within the allowable charging temperature range – 0° C and 40° C (32° F to 104° F). Allow the battery to come to an acceptable range before reinserting Omnii in the docking station.

Omnii Charge Indicator LED is Red

If the Omnii charge indicator is red when Omnii is in any of the four bays, the quad dock cannot read the battery, is in charging timeout, or it is not a Zebra battery.

- Remove the computers and disconnect the adaptor DC power cable.
- Wait at least 20 seconds, and then plug the cable in again.
- If the Omnii indicator still shows a fault, Omnii requires service.

Powered Adaptor LED Stays Off

- Check the AC cable. Replace with the same type if the cable is suspect.
- If the adaptor LED stays OFF, the adaptor is defective and requires service.

Vehicle Cradles - Models ST1000 and ST1002



IMPORTANT

The vehicle cradles are shipped with their own quick start guide — Omnii Vehicle Cradles Quick Start Guide (PN 8000221). It is critical that it be reviewed for additional information and updates.

The Omnii vehicle cradles are highly ruggedized, single station docks. Although they provide quick insertion and removal, the cradles hold Omnii securely even when operated in high vibration environments (such as vehicles not equipped with suspensions).

The Omnii vehicle cradle is available in two models:

- Model ST1000 - Unpowered cradle.
- Model ST1002 - Powered cradle with communications port. A DE9M serial port (powered) and two USB Host interfaces.

Figure 5-16 Front and back of ST1002 with Omnii



Zebra also supplies a range of standard mounts for the hand-held vehicle cradles, and the Omnii vehicle cradles are compatible with all of them.

Vehicle Cradle Mounting Recommendations



WARNING Before mounting a vehicle cradle in a vehicle, there are a number of operator safety issues that require careful attention. An improperly mounted cradle may result in one or more of the following: operator injury, operator visibility obstruction, operator distraction and/or poor ease of egress for the operator. Zebra strongly recommends that you seek professional mounting advice from the vehicle manufacturer.

Ensure that you read the ST1002 Vehicle Cradle Installation Instructions document (PN 1020305), enclosed with the ST1002, for important safety information on connecting fuses.

Cable routing within a vehicle cab also requires careful consideration, especially for devices with loose cables. If you are unable to obtain suitable advice, contact Zebra for assistance. Note also that for better protection, the equipment should be mounted inside the vehicle roll cage.

Pedestal mounts are recommended for all fixed mount locations because they offer optimal operator access. In addition, for safety reasons, only pedestal mounts with fully locking joints should be used in vehicles. Always adjust the pedestal for the optimum viewing angle, and securely tighten the hex and wing screws.

The most effective way to mount the vehicle cradle is to use brackets with the MT3324 (short arm) or MT3325 (standard arm) kit. The ST1002 requires either the MT3326 or MT3327 bracket; the ST1000 requires the MT3328 bracket.



IMPORTANT

It is strongly recommended that all fork lift mounting solutions use clamp bases rather than plate bases that require penetrating through the vehicle for installation.

Choose from one of the following **clamp bases** to secure the vehicle cradle/arm assembly to the vehicle:

- MT3505
- MT3507

Model	Rail Width
MT3505	Clamp base (for 4" or 12" RAM arm), 2" max. width
MT3507	Clamp base (for 4" or 12" RAM arm), 3" max. width
MT3509	Rail base (for 4" or 12" RAM arm), 1-1/4" to 1-7/8"
MT3510	Rail base (for 4" or 12" RAM arm), 2" to 2 1/2"

Figure 5-17 Clamp and Rail Bases (Torque to 26 in-lbs)

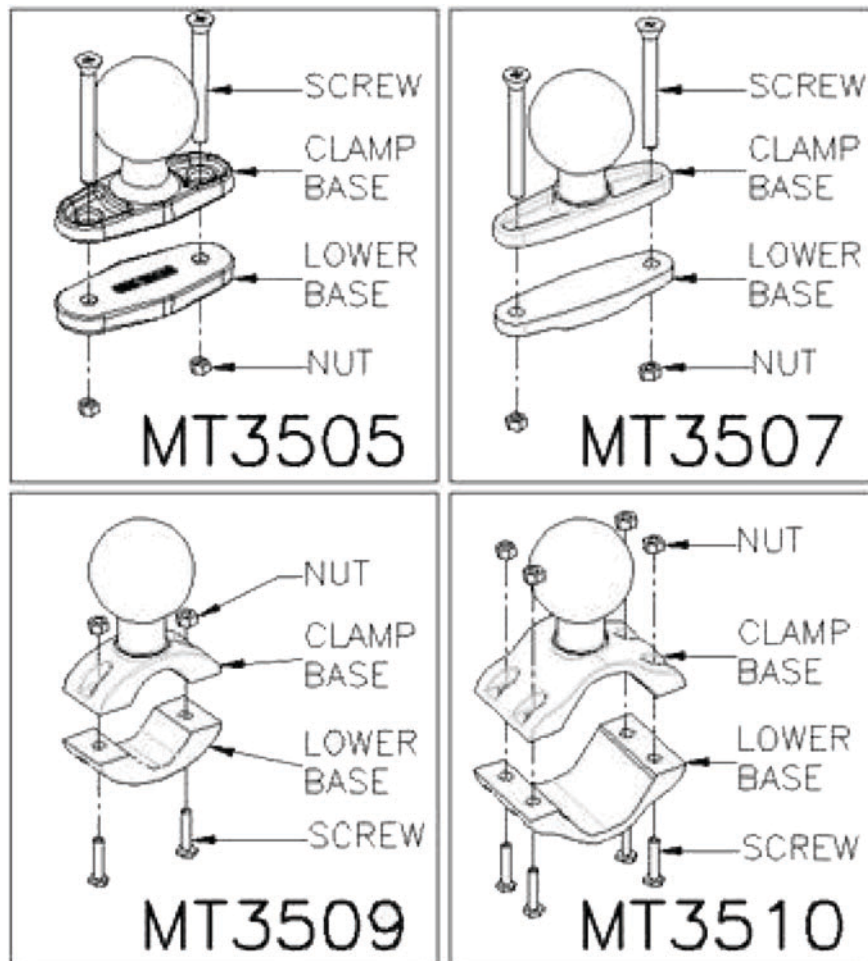

**IMPORTANT**

Plate bases are not recommended for forklift mounting solutions. If a plate rather than a clamp base is used, you will need to penetrate into the structure of the vehicle, a process requiring additional hardware. The following plate bases are available:

- VESA Plate – MT3501
- Circular Plate – MT3502

Figure 5-18 MT3325 Standard Arm Kit with Omnii Vehicle Cradle

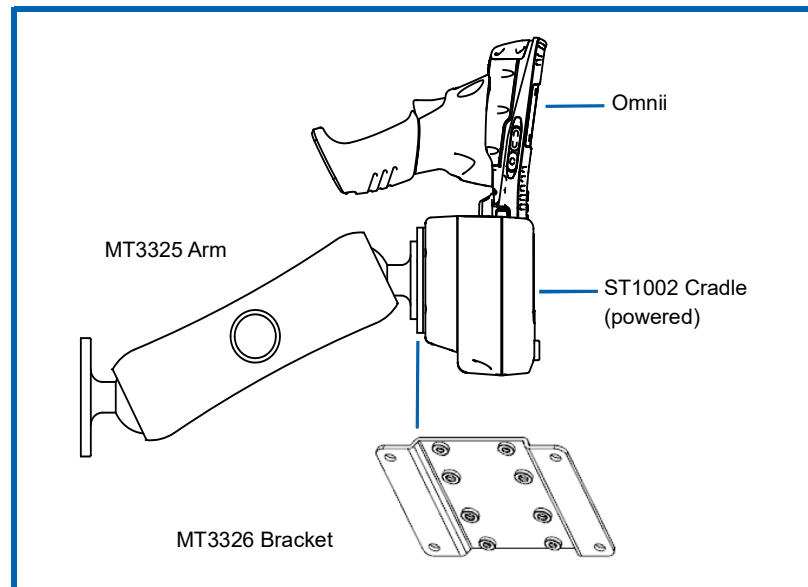

To accommodate the service loop of the connector cable, leave a 4" clearance at the bottom of the cradle. Leave a 7" (minimum) clearance at the top of the cradle to allow easy removal of the hand-held. Refer to the detailed assembly instructions that are packaged with the cradle when selecting a mounting location (Omnii Vehicle Cradles Quick Start Guide PN 8000221).

Insertion and Removal of Omnii

If your Omnii is equipped with a cover, or the ST6025 double loop hand strap, these accessories need to be removed before installing the unit in a vehicle cradle. There is no need to remove other handstraps or pistol grips from the unit.

- Slide Omnii into the cradle, and press firmly downward until it locks into place. On a vehicle, it's a good idea to pull up on Omnii to be certain that it is secure.
- To remove Omnii, press the release button on the front of the cradle until it releases.

Figure 5-19 Inserting Omnii into the vehicle cradle

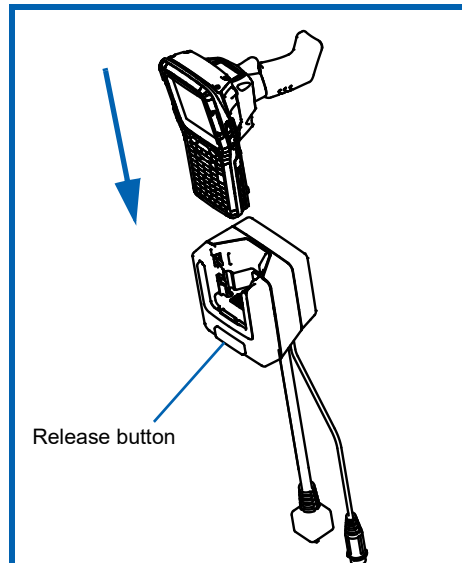

Maintaining the Vehicle Cradle

Two latches in the cradle hold Omnii firmly in place. Although these latches are designed for at least 100,000 insertion and removal cycles, they will wear over time and will no longer lock Omnii securely in the cradle. For replacement parts and instructions contact Zebra. Partial disassembly is required.

ST1002 Powered Cradle Installation

The ST1002 cradle is designed to allow Omnii to be powered by a vehicle battery. The battery installed in Omnii is also recharged by the vehicle battery. This option accepts DC power sources over the range 11.5V to 30V. Voltages above that require the use of the preregulator (Model No. PS1350).



WARNING Applying a voltage greater than that specified, or reversing polarity, may result in permanent damage to the cradle power option and will void the product warranty.

Operating an Omnii XT15f Arctic unit in operating temperatures from -30°C to +50°C, requires the use of the power preregulator Model No. PS1370.

The ST1002 Vehicle Cradle has a 44-pin connector that allows connection with either the CA3001 Vehicle Cradle Power and Communications Cable (DE9M serial port, 2 USB Host interfaces, and power cable) or the power-only CA3000 Vehicle Cradle Power Cable. For connector pinouts and a cable connections diagram, see [“Cable Connectors for Vehicle Cradle Model ST1002” on page A-5.](#)

Figure 5-20 Connecting to vehicle power

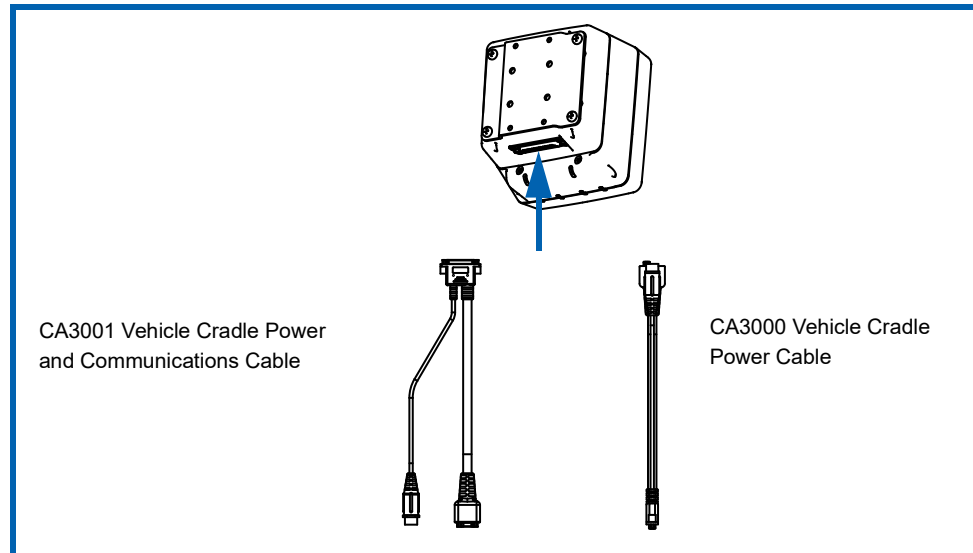

For a diagram of a power with communications setup, see [Figure 5-21 Connecting ST1002 to vehicle power and communications in a typical setup](#) on page 5-25.

The Omnii charging LED (see [“Battery Charge Status LED”](#) on page 2-15) indicates that external power is available, and it also indicates the charging status of the internal battery.

Wiring Guidelines

Before installing the cables between the cradle and other devices, consider the following:

- Ensure that drilling holes will not damage the vehicle or its wiring.
- Protect cable runs from pinching, overheating and physical damage.
- Use grommets to protect cables that pass through metal.
- Use plastic straps and tie-downs to secure cables and connectors in their desired location, away from areas where they may get snagged or pulled.
- Keep cables away from heat sources, grease, battery acid and other potential hazards.
- Keep cables away from control pedals and other moving parts that may damage the cables or interfere with the operation of the vehicle.

Installation in High Voltage Vehicles



WARNING Voltages exceeding 30VDC are considered hazardous. Installation of powered cradles in vehicles that operate above 30VDC require special consideration, as listed below.

Due to the hazardous voltages present on these vehicles, it is necessary to ensure that the powered cradle power supply cable connector is not accessible to the vehicle operator, and does not get exposed to water or other liquids. **Exposing an accessible power connector to water or other liquids could create a hazardous situation resulting in serious injury or death.** Avoiding this hazard can be accomplished in the following way.

- Use the PS1350 pre-regulator or, for freezer applications (-30°C), the PS1370 pre-regulator.

- Ensure the power connector is wrapped securely with a waterproof electrical tape and installed in a dry location on the vehicle, away from the vehicle operator's reach (perhaps under a vehicle dash or in a sealed housing).
- Cover the power connector with a waterproof heat shrink material (see “[Extreme Wet Environments](#)” for additional details).

All other installation requirements outlined in this document should also be followed for High Voltage vehicles to insure safe installation and operation of the powered cradle.

Extreme Wet Environments

For extreme wet environments, or environments where it is difficult to restrict vehicle operator access to the power connector, Zebra offers a waterproof heat shrink kit (PN 1030022). The kit contains 3 pieces of waterproof, high shrink ratio heat shrink tubing which can be used to encapsulate the entire connector assembly. If using this kit, please ensure that you order sufficient material to cover installation and service, remembering that heat shrink is one-time use, and must be replaced if it is removed from the connector for any reason.

Wiring Vehicle Power and Communications to the Cradle

An optional 1.8 meter (6 foot) extension power cable (PN 13985-301 with motion detect or 13985-302) is available for your powered vehicle cradle. This cable should be wired to a filtered, fused (maximum 4A) accessory supply on the vehicle. The power cradle draws no more than 4A (less if the accessory supply is greater than 12V). Any additional wiring, connectors or disconnects used should be rated for at least 10A. Installation of the 19440-XXX fuse assembly using a 4A 250V fuse installed is mandatory, except when using a CA3002 vehicle power cable. The 13985-XXX cables are not used with the CA3002. The 4A fuse is already included in the CA3002 vehicle connector assembly.



NOTE When connecting PN 13985-301 (Screen Blanking version), ensure that the screen blanking wires (clearly labelled) and the power wires (red/black leads) are reliably secured away from each other, or are separated with reliably secured certified insulation. A minimum 2.8mm distance, or 0.4mm distance through insulation, is required for the separation.

The red lead of the power cable attaches to the positive vehicle supply. The black lead connects to the negative supply — this should be connected to a proper terminal block and not to the vehicle body.

You may have the option of connecting power before or after the 'key' switch. It is preferable to wire the power cradle after the key switch — that is, it cannot be turned on without the key on. However, if the operator switches the key off repeatedly for long periods during a shift, it may make more sense to wire the cradle before the switch.

Keep in mind that Omnii will continue to operate with or without vehicle power as long as its battery has sufficient charge. If an unfused power source must be used, a fuse assembly (PN 19440-300) must be added to the extension power cable (the fuse and instructions are supplied with the cable). Use only a 4A fast blow UL approved fuse in the fuse assembly (PN 9016622).



WARNING 11.5–30 Vdc input only, suitable for road vehicles. A pre-regulator is required for use on forklifts. For such installations, Zebra recommends using the PS1350 (15-90 VDC) pre-regulator or, for freezer applications, the PS1370 pre-regulator.

Figure 5-21 Connecting ST1002 to vehicle power and communications in a typical setup

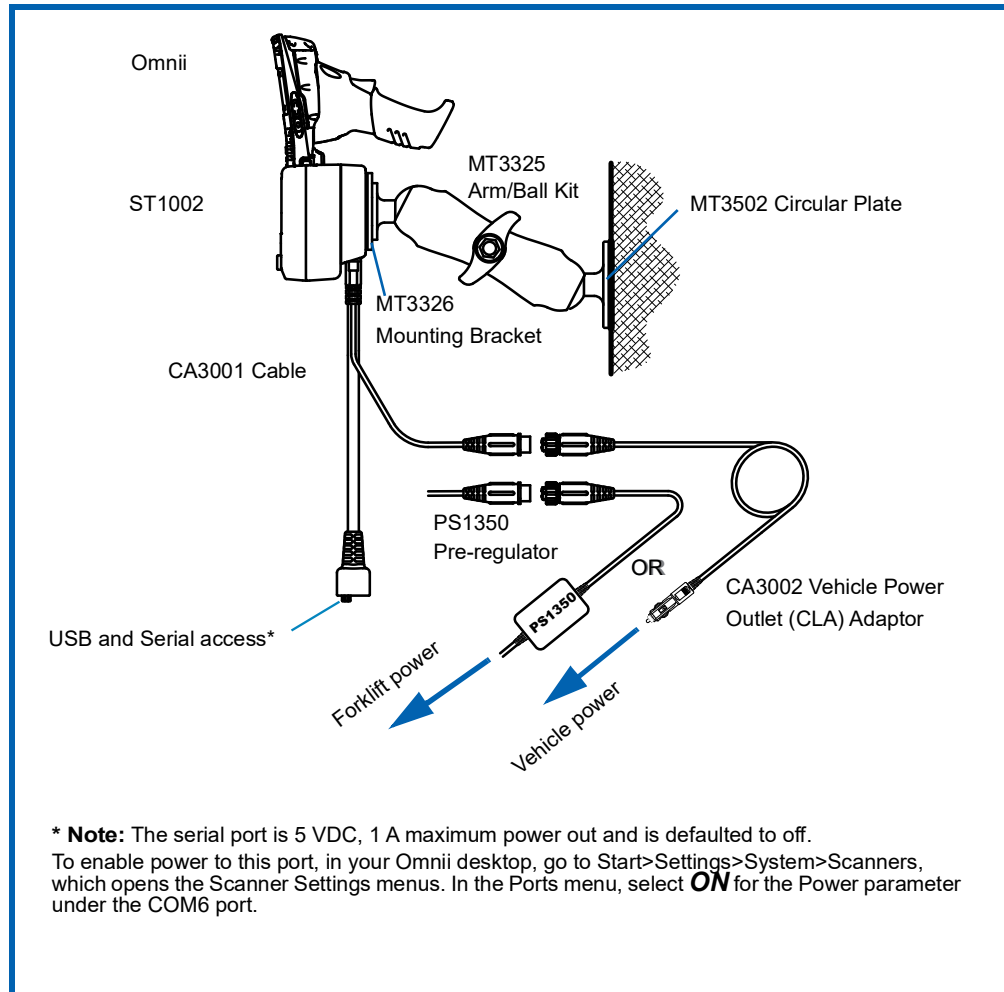

NOTE For the CA3002 Vehicle Power Outlet (CLA) Adaptor, replace with same fuse type and rating.

Battery Charger (6-Slot) - Model ST3006

The ST3006 is designed to charge up to six Omnii lithium-ion batteries at one time.



IMPORTANT

The battery charger is shipped with its own quick start guide — ST3006 6-Slot Battery Charger Quick Start Guide (PN 8000204). It is critical that it be reviewed for additional information and updates.



IMPORTANT

When ordering a charger, you must also order an IEC-320/IEC-60320 C13 power cord separately.

Figure 5-22 ST3006 Battery Charger

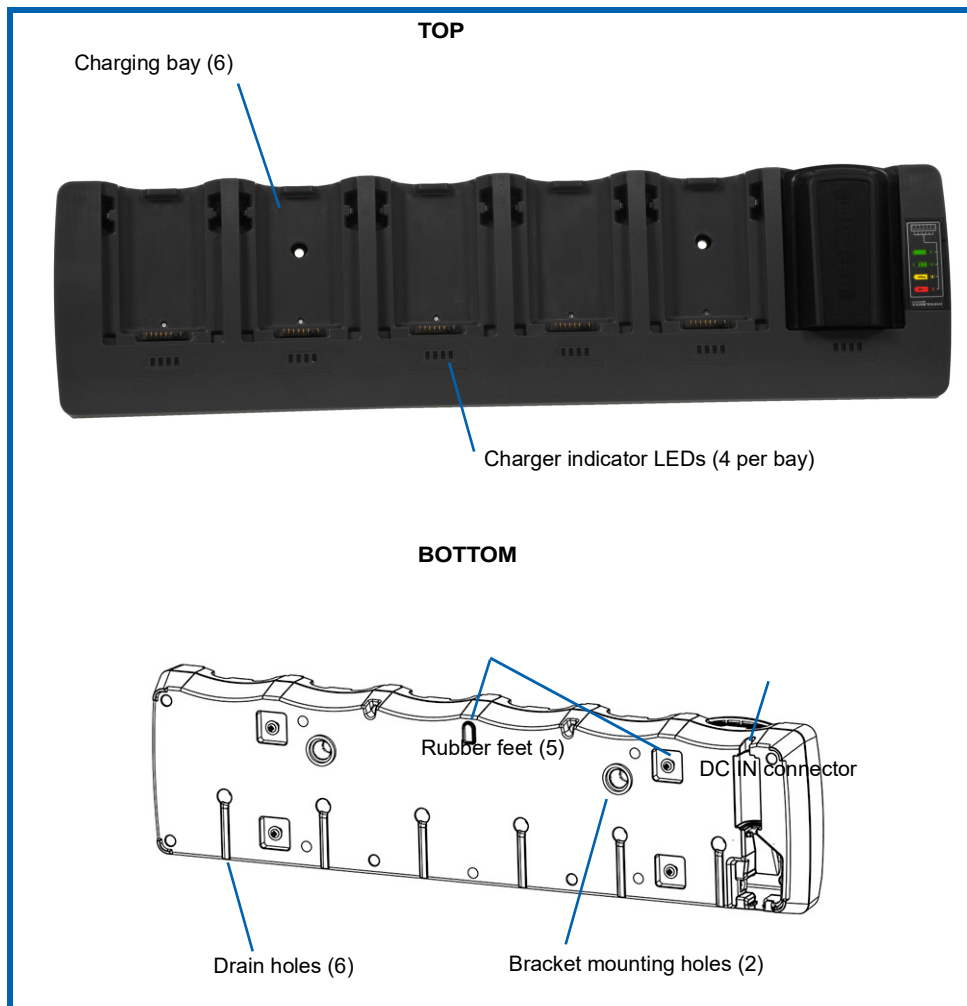

Installation

The charger can be wall mounted using the wall mount kit (MT2031) or it can be operated on a flat surface. Install the charger in an area that is free from excessive dirt, dust and contaminants. The ambient temperature must be in the range 5°C to 39°C (41°F to 102°F). The charger will not charge batteries outside of this temper-

ature range. For maximum performance, it is recommended that the charger be operated at room temperature — a temperature range between 18°C to 25°C (64°F to 77°F).

The charger can consume up to 6 A at 120 VAC, 3A at 240 VAC. Check to ensure the mains circuit supplying the charger is adequate for this loading (especially if several chargers are being powered from the same circuit). After unpacking the unit:

- Visually check the charger for damage.
- Install the IEC power cord and apply power.



IMPORTANT Use IEC-320 C13 power cords approved by Zebra, with the ground pin connected to a proper earth-grounded receptacle. Check with a qualified electrician if you are uncertain of your receptacle grounding.

All charge indicators flash momentarily at power up to indicate that the charger is ready for operation.

If you choose to wall mount the charger, detailed installation instructions are included in the Omnii 6-Slot Battery Charger ST3006 Quick Start Guide (PN 8000204) included with the charger kit. Be sure to locate the charger in an area where there is no risk of injury to persons walking in the vicinity.

Operator Controls

The gang charger does not have operator controls or a power switch. There is no dedicated indicator light to show that the charger is powered, but the charge slot LEDs will light up briefly when first applying power.

Charge Indicators

Each battery charge slot is equipped with four LEDs to indicate the charge status of the battery. When the Omnii batteries are inserted in the charger, the colour and behaviour of the LEDs associated with the charging bays in use indicate the status of the charge.

Charge LED Behaviour	Function
OFF	No battery detected.
Solid Green	Battery charging complete. Each LED represents 25% battery capacity.
Flashing Green	Charge in progress. Each LED represents 25% battery capacity.
Flashing Yellow	Battery is not charging due to out-of-temperature conditions.
Solid Red	Unable to read battery, charging timeout, or non Zebra battery.

Charging Batteries

- Install the battery with the battery contacts facing the charger. Slide the battery between the guide rails until it lightly latches in place.

The 4-LED bar for the battery bay shows 25% charger per LED. A flashing green LED shows charging is under way. The LED directly below the slot in which a battery is inserted lights up immediately. If the battery temperature is outside 0°C to 40°C (32°F to 104°F), the LED flashes yellow until the temperature is acceptable. A fully discharged battery will normally take 4.5 hours to charge. At full capacity, it turns solid green.

When the battery is fully charged, the charger stops applying power; the battery cannot be overcharged if left in the charger slot.

Troubleshooting

Improper Battery Storage

Storing batteries in the gang charger for extended periods (more than a week or two) is not recommended. Lithium-ion batteries lose capacity if they are maintained at full charge for long periods of time. See the battery handling recommendations in [“The Battery” on page 1-5](#).

Power Self-test LEDs Don't Light Up

The charge slot LEDs will light up briefly when first applying power indicating the self-test mode. When applying power to the unit, all the LEDs will light up. Yellow will show up in the 25% LED for each bay; green for other LEDs. Then bay #1 will blink a binary representation of the firmware version (V09 = 1001). If the self-test is not evident:

- Remove all batteries, and unplug the charger.
- Connect another device to the mains outlet to ensure there is power.
- Remove the IEC mains power cable from the charger, and check it for damage.
- Reconnect the mains cable in the charger and mains outlet.

Indicator Does Not Light When Battery Installed

- Remove the battery, and clean the contacts on the battery and the charge slot.
- Reinstall the battery, and check that it is fully seated in the slot.
- Inspect the charge slot contacts for damage (are they bent, flattened, twisted or broken).
- Try inserting a battery that you know to be working in the charger slot.
- Reconnect the mains power cable, and check that the slot indicator flashes at power up.

APPENDIX A PORT PINOUTS

Omnii Docking Connector	A-3
Snap Modules Connectors	A-4
Cable Connectors for Vehicle Cradle Model ST1002.	A-5
Omnii Battery Contacts	A-6

Omnii Docking Connector

The docking interface on the base of Omnii is custom-designed to dock with a device via an array of spring-mounted pins.



The following are the pin assignments of the interface.

Pin #	Signal	Pin #	Signal
1	GROUND	11	USB_OTG_P
2	DC_IN	12	USB_OTG_M
3	DOCK_LOW_PWR	13	CHARGE_IN
4	GROUND	14	GROUND
5	USB_OTG_VBUS	15	DC_IN
6	CHARGE_IN	16	UART_RX
7	GROUND	17	GROUND
8	DC_IN	18	UART_TX
9	USBH_P	19	CHARGE_DATA
10	USBH_M	20	GROUND

Snap Modules Connectors

- **Model ST4000** (Charger only variant): power and charge.
- **Model ST4001** (USB Host/Client variant): power, charge, communications via USB 1.1/2.0 Host and USB 2.0 Client connectors, DC IN port.
- **Model ST4005** (DE9M Serial variant): powered DE9M serial connector, power, charge, serial communications. Pin 9 is reserved for 5V 1A max power out and is defaulted to **off**.

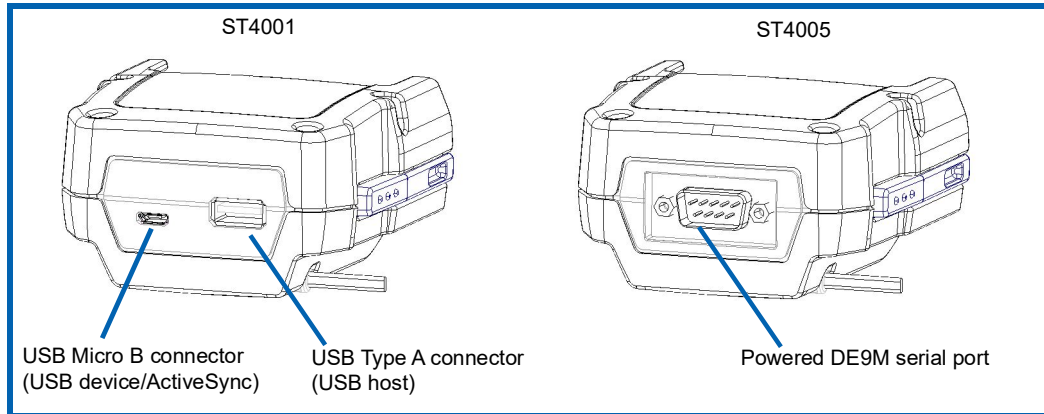

The following are the pin assignments of the interfaces.

ST4001				ST4005	
USB Micro B Connector		USB Type A Connector		DE9M Serial Connector	
Pin #	Signal	Pin #	Signal	Pin #	Signal
1	VBus	1	VBus	1	DCD
2	D-	2	D-	2	RXD
3	D+	3	D+	3	TXD
4	ID	4	GROUND	4	DTR
5	GROUND	5	SHIELD	5	GROUND
		6	SHIELD	6	DSR
				7	RTS
				8	CTS
				9	5Vdc 1A power out

Cable Connectors for Vehicle Cradle Model ST1002

- The ST1002 Vehicle Cradle has a 44-pin connector that allows connection with either the CA3001 Vehicle Cradle Power and Communications Cable (DE9M serial port, 2 USB Host interfaces, and power cable) or the power-only CA3000 Vehicle Cradle Power Cable. For installation details, see “[ST1002 Powered Cradle Installation](#)” on page 5-22.

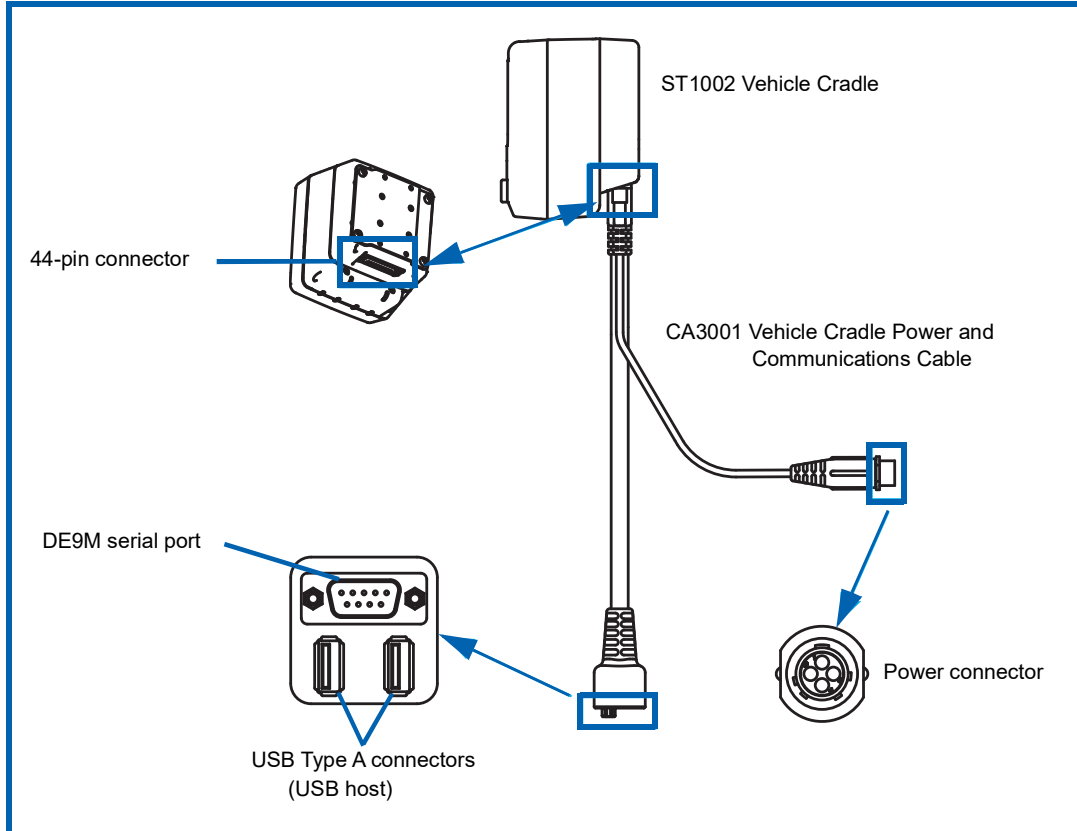

The following are the pin assignments of the interfaces.

DE9M Serial		USB Type A		Power	
Pin #	Signal	Pin #	Signal	Pin #	Signal
1	DCD	1	VBus	1	VIN (11.5 to 30Vdc)
2	RXD	2	D-	2	GND (not chassis ground)
3	TXD	3	D+	3	MOTION DETECT
4	DTR	4	DGROUN D	4	MOTION DETECT RETURN (not ground)
5	GROUND				
6	DSR				
7	RTS				

DE9M Serial		USB Type A		Power	
Pin #	Signal	Pin #	Signal	Pin #	Signal
8	CTS				
9	5Vdc 1A power out				

Omnii Battery Contacts

Figure A-1 Battery Contact Pinout



Pin #	Signal Name	Description
1	BATT+	Positive lead of battery.
-		Plastic Rip - provides mechanical polarity.
2	BATT+	Positive lead of battery.
3	BATT-CLK	SMBus data clock.
4	BATT-ID	Connected to GND in the battery.
5	BATT-DATA	SMBus bi-directional data line.
6	GND	Negative lead of battery.
7	GND	Negative lead of battery.

APPENDIX B IMAGERS APPLET

The Imagers Applet	B-3
Required Applets	B-3
Presets	B-3
Predefined Presets	B-3
Barcode Predefined Presets	B-3
Barcode Decoding Symbology Predefined Presets	B-4
Barcode Decoding Camera Predefined Presets.	B-4
Image Capture Predefined Presets.	B-5
Using the Imagers Applet.	B-5
Configuring the Image Capture Presets	B-5
Selecting a Camera	B-6
Setting the Active Preset	B-6
Viewing a Preset.	B-6
Creating a Custom Preset.	B-6
Modifying a Custom Preset	B-7
Removing a Custom Preset.	B-8
Configuring the Barcode Decoding Camera Presets	B-8
Selecting a Camera	B-9
Setting the Active Preset	B-9
Viewing a Preset.	B-9
Creating a Custom Preset.	B-10
Modifying a Custom Preset	B-11
Removing a Custom Preset.	B-12
Configuring the Barcode Decoding Symbologies	B-12
Setting the Active Preset	B-12
Viewing a Preset.	B-12
Creating a Custom Preset.	B-13
Modifying a Custom Preset	B-14
Removing a Custom Preset.	B-15
Filter Tab – Manipulating Barcode Data	B-15

Modifying a Barcode Setting	B-15
Translation Tab – Configuring Rules	B-16
Case Rules	B-17
Advanced Tab.	B-18
File Locations for Captured Images	B-18
Configuring Triggers	B-18
Barcode Symbologies	B-19
Imager Barcode Symbologies	B-20
Color Camera Barcode Symbologies	B-21

The Imagers Applet

The Imagers applet is used to create, modify, delete and activate imager settings. The principle uses of the applet are to decode barcodes and to capture images. A Demonstration Application is provided to demonstrate how the imager works. Refer to [“Imager and Camera Demo” on page 3-31](#) for details.

Required Applets

In order to configure imaging, the Manage Triggers applet must be present in the Settings>System tab along with the Imagers applet.

Presets

There are two methods that can be used to configure an imager using the Imagers applet:

- Use a predefined preset.
- Create a custom preset based on a predefined preset.



IMPORTANT

It is strongly recommended that a predefined preset is used whenever possible. Each predefined preset contains a coherent group of settings that are known to work together in the intended environment. In almost all situations, at least one of the predefined presets results in a satisfactory outcome.

A preset is a group of exposure and image correction settings. Each preset configures the imager for a specific purpose such as barcode decoding or image capture.

Presets also allow easier and faster configuration of the imager after power-on or resume from suspend.

The predefined presets are generic and satisfy most user requirements. A custom preset can be created for a specific user application, such as: include only specified barcodes, read only a specified number of barcodes or for reading unusual media.

Every preset belongs to a preset type. The following preset types are available:

- Imaging for photo capture.
- Imaging for barcode decoding.
- Symbology selection.

At any time, only one preset of each type can be designated as the user-selected active preset.

Predefined Presets

Predefined presets are built into the imaging software and cannot be changed. The predefined presets allow you to use the imager to perform specified tasks without having to understand and set numerous variables. In almost all cases these predefined presets are sufficient.

Barcode Predefined Presets

These presets encompass the majority of the most popular barcodes and their subtypes. The barcode decoding symbology predefined presets define which barcodes can be decoded. The barcode decoding camera predefined presets determine how the barcode images are captured

Barcode Decoding Symbology Predefined Presets

The following presets select groups of similar barcodes for decoding.



NOTE It is recommended that the default preset be used whenever possible.

Factory Default

This preset enables the decoding of frequently used barcodes.

My Default

The barcodes in this preset can be enabled, disabled and so on.

All

This preset enables the decoding of all barcodes that the imager can decode. For a list of these symbologies see [“Imager Barcode Symbologies” on page B-20](#) and [“Color Camera Barcode Symbologies” on page B-21](#).

Linear

This preset enables the decoding of all the 1D symbologies that the imager can decode. For a list of these symbologies see [“Imager Barcode Symbologies” on page B-20](#) and [“Color Camera Barcode Symbologies” on page B-21](#)

Linear and PDF417

This preset enables the decoding of all the 1D and PDF symbologies that the imager can decode. For a list of these symbologies see [“Imager Barcode Symbologies” on page B-20](#) and [“Color Camera Barcode Symbologies” on page B-21](#)

Matrix

This preset enables the decoding of all 2D symbologies that the imager can decode. See [“Imager Barcode Symbologies” on page B-20](#) and [“Color Camera Barcode Symbologies” on page B-21](#) for a list of these symbologies.

Postal

This preset enables the decoding of all the postal symbologies that the imager can decode. See [“Imager Barcode Symbologies” on page B-20](#) and [“Color Camera Barcode Symbologies” on page B-21](#) for a list of these symbologies.

Barcode Decoding Camera Predefined Presets

The following presets enable successful barcode image capture in almost all conditions.



NOTE It is recommended that the default preset be used whenever possible.

Default

This preset works in a wide range of conditions. It is optimized for a normal office lighting (about 300 Lux).

Low light

This preset is designed for very dark conditions such as inside a warehouse where the lights are kept low, or inside an unlit truck. This preset increases either the exposure time or the gain.

Low power

This preset minimizes the use of the flash so as to conserve the battery power on the Omnii.

Glossy surface

This preset minimizes the use of the flash so as to reduce reflection. This preset is used to read barcodes that are behind glass, or inside the plastic window of an envelope.

Image Capture Predefined Presets

The following presets enable successful image capture in almost all conditions.



NOTE It is recommended that the default preset be used whenever possible.

Default

This preset works in a wide range of conditions. It is optimized for a normal office lighting (about 300 Lux).

Motion

This preset uses a shorter exposure time so as to freeze motion.

Low light near

This preset is designed for dark conditions, it uses a longer exposure time and includes the flash.

Using the Imagers Applet**Configuring the Image Capture Presets**

To configure the image capture presets, open the dialog box as follows:

- Tap on **Start>Settings>System** icon.
- Tap on the **Imagers** icon, and if it's not already selected, tap on the **Imaging** tab.

The following screen is displayed:

Figure B-1 *Imaging Tab*

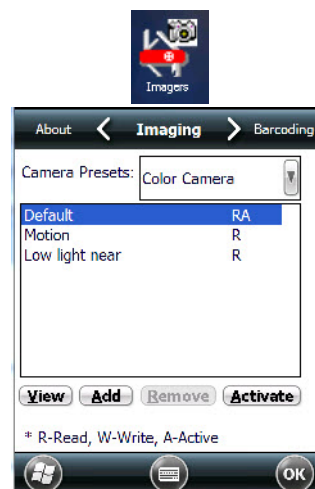

This window lists all the presets, both predefined and custom. Presets are identified as follows:

- Predefined presets are marked as read-only.
- Custom presets are marked as read and write.
- One preset – either predefined or custom – is marked as active.

Selecting a Camera

Your Omnii has a built-in imager and a camera. One camera must be selected for configuration. To select a camera:

- Tap on the **Camera Presets** drop-down menu to view the camera options.
- Choose a **camera** – either Imager, the imager located at the top of the unit, or Colour Camera, the camera located at back of the Omnii.

Setting the Active Preset

An active preset has an A to the right. To set an active preset:

- Highlight the preset, and tap on the **Activate** button.

Viewing a Preset

To view the parameter settings in a preset:

- Highlight a preset, and tap on the **View** button.

The associated preset window is displayed.

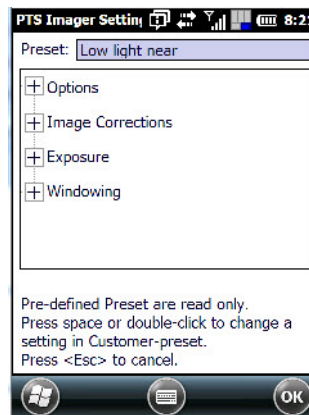

- Tap on the + sign to expand the lists so that you can view the parameter settings.

Creating a Custom Preset

A new custom preset is created by modifying a preset – either a predefined preset or an existing custom preset. To create a custom preset:

- Highlight a preset, and tap on the **Add** button.

In this example, the Low light near preset was chosen. A screen like the sample below is displayed.

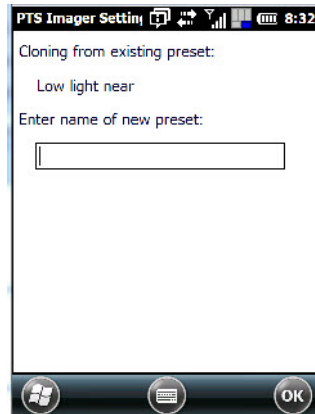

- Type the **name** of the new preset in the dialog box.
- Tap on **OK** to save your changes.

The preset list is displayed; the new custom preset appears at the end of the list. It is marked as read and write.

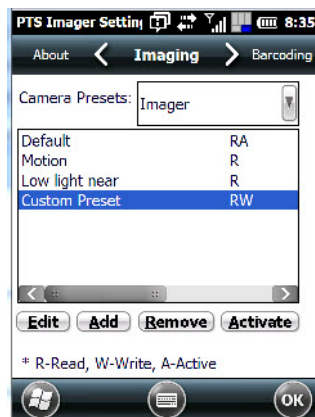

Modifying a Custom Preset

The parameter values in a custom preset can be modified. It is recommended that very few changes be made to a custom preset. To ensure that it will work reliably, it should be as close as possible to the original predefined preset. To change a parameter value:

- Highlight the **custom preset**, and tap on the **Edit** button.

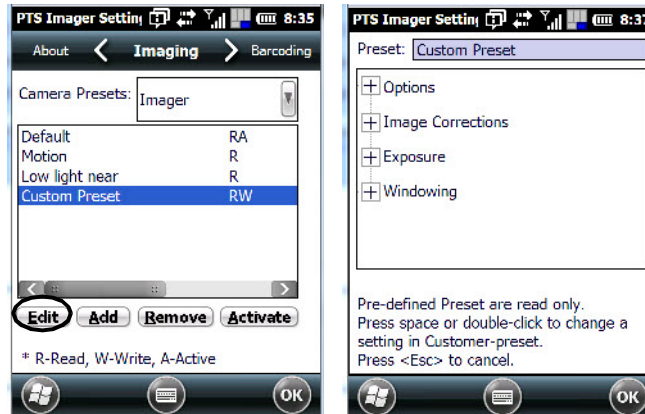

- Tap on the + symbols to expand the lists so that you can view the parameter settings.
- Scroll through the parameter list until you reach the parameter that you want to change.
- For a parameter that can take a range of values:
 - Highlight the parameter, and then press the [SPACE] key or double-click the parameter.
 - An associated dialog box containing the valid range of values for the parameter and the current setting like the sample screen following is displayed.
 - Type a value in the field provided.
- For a parameter that toggles between two values such as on or off and enabled or disabled:
 - Highlight the parameter and then press the [SPACE] key, or double-click on the parameter. Either method toggles between the two available values.
- When you've completed your edits, tap on **OK**.

The parameter list is displayed; the new value for the changed parameter is shown.

- Tap on **OK** to exit to the preset list and save the changes.

Removing a Custom Preset

- Highlight the custom preset you want to delete, and tap on the **Remove** button.

A window is displayed warning you that you are about to remove a preset.

- Tap on **Yes** to remove the preset or **No** to cancel the operation.

Configuring the Barcode Decoding Camera Presets

To configure the barcode decoding camera presets:

- Tap on **Start>Settings>System** icon.
- Tap on the **Imagers** icon, and scroll to the **Barcoding** tab.

Figure B-2 Barcode Presets

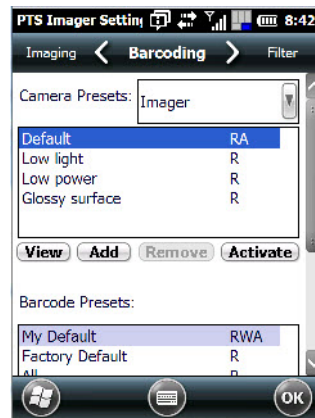

This window lists all the presets, both predefined and the custom. Presets are identified as follows:

- Predefined presets are marked as read-only. For a description, review “Predefined Presets” on page B-3.
- Custom presets are marked as read and write.
- One preset – either predefined or custom – is marked as active.



NOTE The top portion of the window displays the barcode decoding presets.

Selecting a Camera

One camera must be selected for configuration. To select a camera:

- Tap on the **Camera Presets** drop-down menu to view the camera options.
- Choose a **camera** – either Imager, the imager located at the top of the unit, or Color Camera, the camera located at back of the Omnii.



IMPORTANT Currently, only the ‘Imager’ can be used to read barcodes. The Color Camera is limited to taking photos.

Setting the Active Preset

An active preset has an A to the right; in [Figure B-2 Barcode Presets](#) on page B-9 on at the beginning of this section, the active preset is Default. To set an active preset:

- Highlight the preset, and tap on the **Activate** button.

Viewing a Preset

To view the parameter settings in a preset:

- Highlight a preset, and tap on the **View** button.

The associated preset window is displayed.

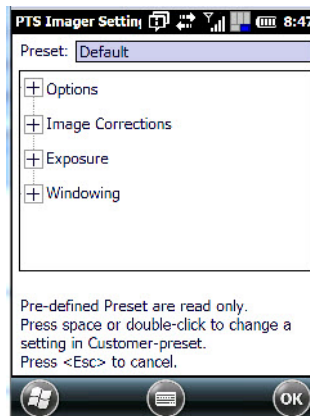

- Tap on the + sign to expand one of the lists so that you can view the parameter settings.

Creating a Custom Preset

A new custom preset is created by modifying a preset – either a predefined preset or an existing custom preset. To create a custom preset:

- Highlight a preset, and tap on the **Add** button.

A screen like the sample following is displayed.

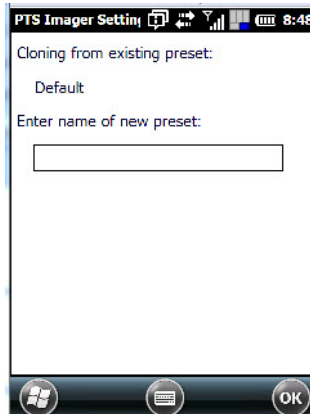

- Type the **name** of the new preset in the dialog box.
- Tap on **OK** to save your changes.

The preset list is displayed; the new custom preset appears at the end of the list. It is marked as read and write.

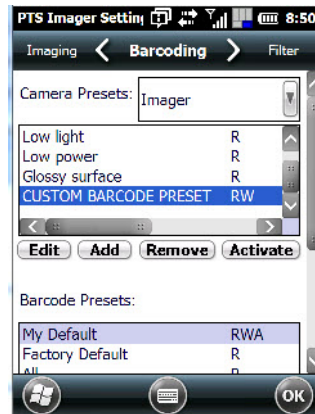

Modifying a Custom Preset

The parameter values in a custom preset can be modified. It is recommended that very few changes be made to a custom preset. To ensure that it will work reliably, it should be as close as possible to the original predefined preset. To change a parameter value:

- Highlight the **custom preset**, and tap on the **Edit** button.

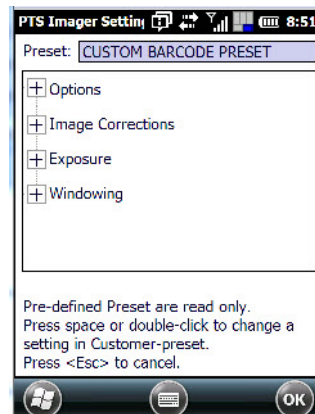

- Tap on the + symbols to expand the lists and view the parameter settings.
- Scroll through the parameter list until you reach the parameter that you want to change.
- For a parameter that can take a range of values:
 - Highlight the parameter, and then press the [SPACE] key or double-click the parameter.
 - An associated dialog box containing the valid range of values for the parameter and the current setting is displayed.
 - Type a value in the field provided.
- For a parameter that toggles between two values such as on or off and enabled or disabled:
 - Highlight the parameter and then press the [SPACE] key, or double-click on the parameter. Either method toggles between the two available values.
- When you've completed your edits, tap on **OK**.

The parameter list is displayed; the new value for the changed parameter is shown.

- Tap on **OK** to exit to the preset list and save the changes.

Removing a Custom Preset

- Highlight the custom preset you want to delete, and tap on the **Remove** button.
- A window is displayed warning you that you are about to remove a preset.
- Tap on **Yes** to remove the preset or **No** to cancel the operation.

Configuring the Barcode Decoding Symbologies

To configure the barcode decoding presets:

- Tap on **Start>Settings>System>Imagers** icon.
- Tap on the **Barcoding** tab.
- Scroll down to view your barcode options.

Figure B-3

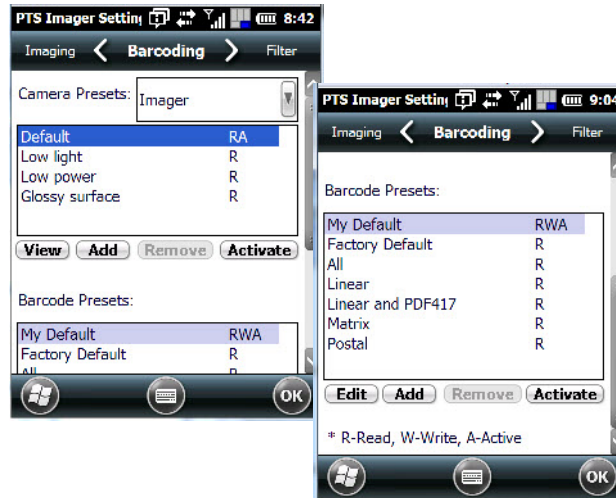

Setting the Active Preset

An active preset has an A to the right; in the Figure B.3 above, the active preset is My Default. To set an active preset:

- Highlight the preset, and tap on the **Activate** button.

Viewing a Preset

To view the parameter settings in a preset:

- Highlight a preset, and tap on the **View** button.

The associated preset window is displayed.

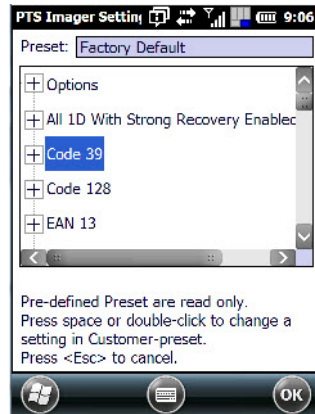

- Tap on the + sign to expand one of the lists so that you can view the parameter settings.

Creating a Custom Preset

A new custom preset is created by modifying a preset – either a predefined preset or an existing custom preset. To create a custom preset:

- Highlight a preset, and tap on the **Add** button.

A screen like the sample following is displayed.

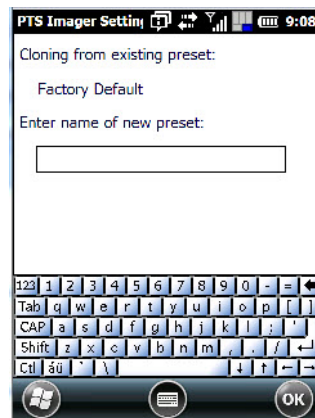

- Type the **name** of the new preset in the dialog box.
- Tap on **OK** to save your changes.

The preset list is displayed; the new custom preset appears at the end of the list. It is marked as read and write.

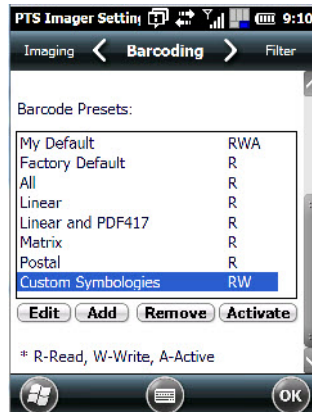

Modifying a Custom Preset

The parameter values in a custom preset can be modified. It is recommended that very few changes be made to a custom preset. To ensure that it will work reliably, it should be as close as possible to the original predefined preset. To change a parameter value:

- Highlight the **custom preset**, and tap on the **Edit** button.

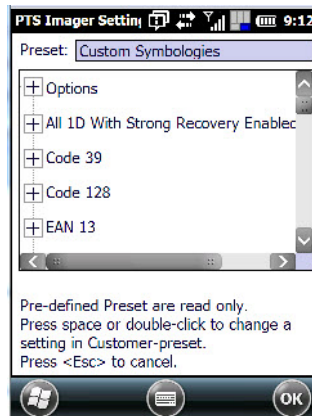

- Tap on the + symbols to expand the lists and view the parameter settings.
- Scroll through the parameter list until you reach the parameter that you want to change.
- For a parameter that can take a range of values:
 - Highlight the parameter, and then press the [SPACE] key or double-click the parameter.
 - An associated dialog box containing the valid range of values for the parameter and the current setting is displayed.
 - Type a value in the field provided.
- For a parameter that toggles between two values such as on or off and enabled or disabled:
 - Highlight the parameter and then press the [SPACE] key, or double-click on the parameter. Either method toggles between the two available values.
- When you've completed your edits, tap on **OK**.

The parameter list is displayed; the new value for the changed parameter is shown.

- Tap on **OK** to exit to the preset list and save the changes.

Removing a Custom Preset

- Highlight the custom preset you want to delete, and tap on the **Remove** button.

A window is displayed warning you that you are about to remove a preset.

- Tap on **Yes** to remove the preset or **No** to cancel the operation.

Filter Tab – Manipulating Barcode Data

To configure rules for manipulating barcode data:

- Tap on **Start>Settings>System** tab.
- Tap on the **Imagers** icon, and then tap on the **Filter** tab.

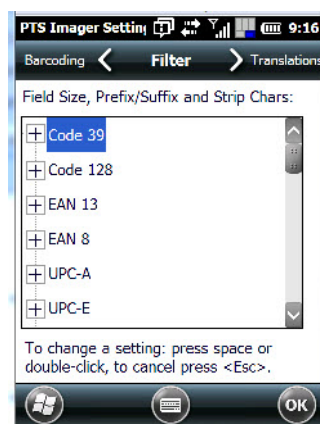

Modifying a Barcode Setting

The rules for manipulating data from selected barcode symbologies can be modified. To change the settings for a symbology:

- Tap on the + symbols to expand the lists and view the parameter settings.
- Scroll through the parameter list until you reach the parameter that you want to change.
- For a parameter that can take a range of values:
 - Highlight the parameter, and then press the [SPACE] key or double-click the parameter.
 - An associated dialog box containing the valid range of values for the parameter and the current setting is displayed.
 - Type a value in the field provided.
- For a parameter that takes a single character:

- Highlight the parameter and then press the [SPACE] key, or double-click on the parameter. The following screen is displayed:

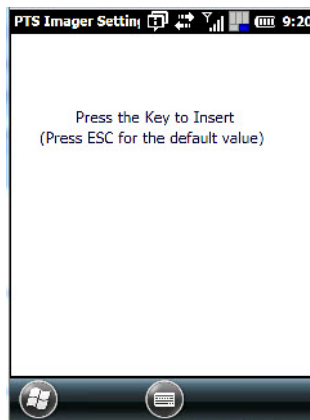

- When you've completed your edits, tap on **OK**.

Translation Tab – Configuring Rules

Translation rules enable the automatic processing of barcode data. Up to 10 cases can be defined, each consisting of up to 10 sequential rules.

- Tap on **Start>Settings>System** tab.
- Tap on the **Imagers** icon, and then tap on the **Translation** tab.

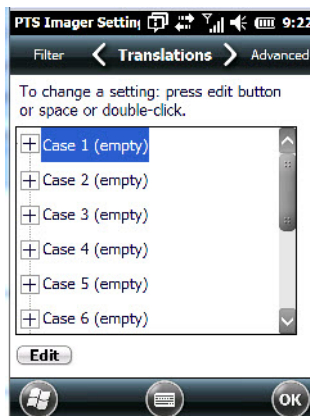

- In the Translations tab, double-tap on a **Case #** to create rules.

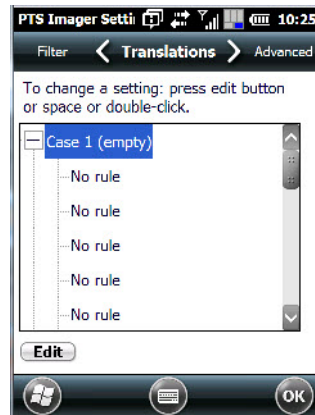

- Tap on the **No rule** drop-down menu to display the rules.

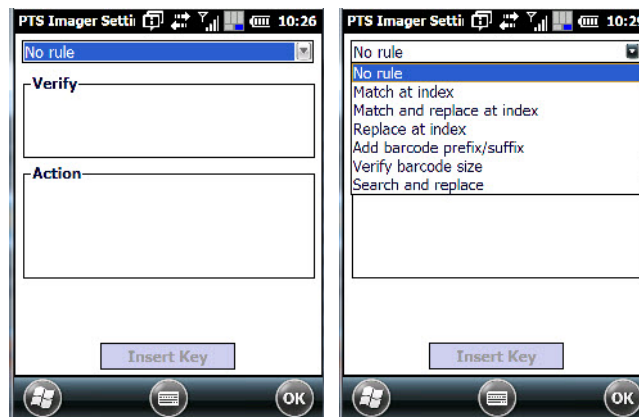

When you choose a rule, an associated screen is displayed in which you can define the rule.

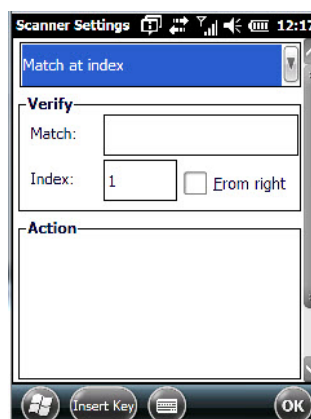

Case Rules

The case rules are defined as follows:

- **No rule** – ignored.
- **Match at index** – matches the match string at a specified index.
- **Match and replace at index** – matches the match string at a specified index and replaces/changes it.

- **Replace at index** – replaces/changes unspecified data in a given range.
- **Add barcode prefix/suffix** – adds a global prefix or suffix.
- **Verify barcode size** – verifies the barcode size. This rule should generally be assigned first, before creating subsequent rules.
- **Search and replace** – replaces all instances of the match string. (Note that this rule cannot fail.)



IMPORTANT

Keep in mind that the effects of previously applied rules must be taken into account when creating subsequent rules. For example, if the barcode size is important, it should be checked before any rules that might change the size are applied.

Advanced Tab

File Locations for Captured Images

To configure the location for saved images, open the dialog box as follows:

- Tap on **Start>Settings>System**.
- Tap on the **Imagers** icon, and then tap on the **Advanced** tab.

To define the location where imager files will be stored:

- Tap on the **File Location** button.

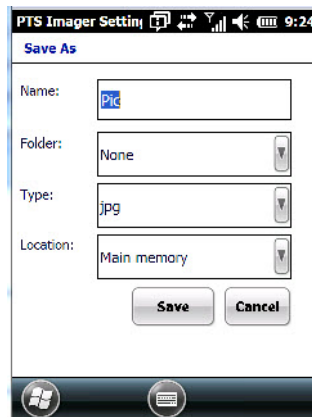

- Type the file **Name**, choose the **Folder** and file **Type**.
- Choose the **Location** in which your files will be saved.
- When you have completed all the changes, tap on the **Save** button.

Configuring Triggers

Viewing The Trigger Configuration

The trigger on the Omnii hand-held is configured using the Manage Triggers applet. The Imagers applet provides a shortcut to the Manage Triggers applet.

- In the Advanced tab, tap on the **Trigger Control** button.
- To view all the triggers and the hardware devices that are configured to use them, tap in the checkbox next to **Show all modules**.

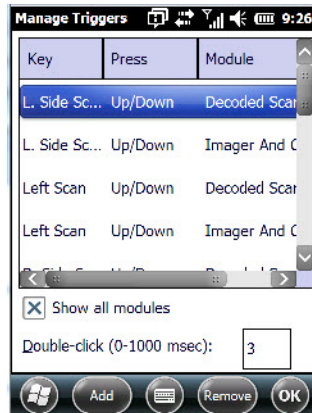

Adding, Editing and Removing Triggers

For instruction about adding, editing and removing triggers, refer to “[Manage Triggers](#)” on page 4-72.

Barcode Symbologies

There are two sets of barcode symbologies, one for Imager and one for Color Camera. To display the barcodes available:

- In the PTS Imager Settings screen, scroll to the **Barcoding** tab.
- In the Camera Presets: drop-down menu at the top of the PTS Imager Settings screen, choose Imager or **Color Camera** depending on which set of barcodes you want to work with.

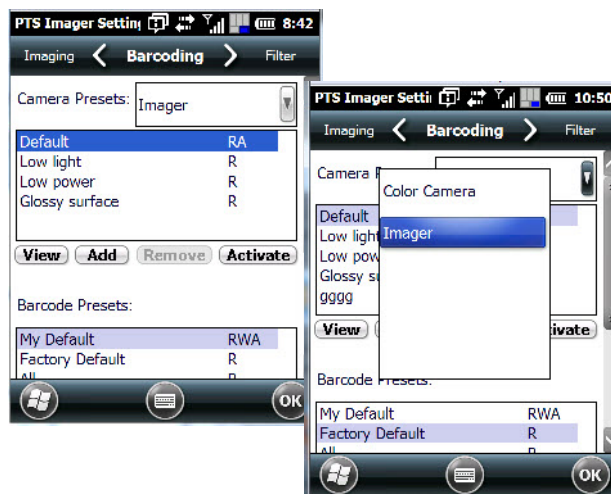

- Scroll down to the **Barcode Presets**.

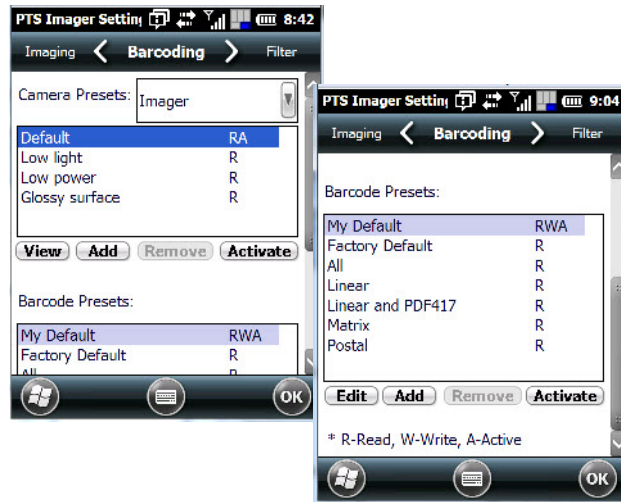

- Tap on an **Barcode Preset** to display the barcode symbologies.

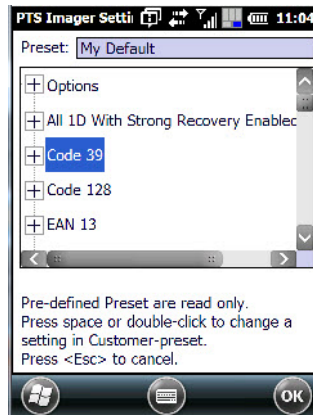

Imager Barcode Symbologies

The barcode symbologies for the Imager are listed in this section.

Imager Barcode Symbologies
All 1D With Strong Recovery Enabled
Code 39
Code 128
EAN 13
EAN 8
UPC-E
UPC-A
UPC/EAN Sharing Settings
Code 93 (disabled)

Imager Barcode Symbologies
MSI Plessey (disabled)
Code 11 (disabled)
Interleaved 2 of 5 (disabled)
Matrix 2 of 5 (disabled)
Discrete 2 f 5 (disabled)
Telepen (disabled)
Gs1 DataBar (disabled)
TLC-39 (disabled)
2D PDF-417
2D micro PDF-417
CodaBlock F (disabled)
CodaBlock A (disabled)
2D Data Matrix
2D QR Code
2D Maxicode (disabled)
2D Aztec (disabled)
Postal: PlanNET (disabled)
Postal: PostNET (disabled)
Postal: China (disabled)
Postal: Japanese (disabled)
Postal: Kix (disabled)
Postal: Royal (disabled)
Gs1

Color Camera Barcode Symbologies

The barcode symbologies for the Color Camera are listed in this section.

Color Camera Barcode Symbologies
All 1D With Strong Recovery Enabled
Code 39
Code 128
EAN 13
EAN 8
UPC-E

Color Camera Barcode Symbolologies
UPC-A
Code 93 (disabled)
Codabar
Interleaved 2 of 5 (disabled)
Gs1 DataBar (disabled)
Gs1 Composite
2D PDF-417
2D micro PDF-417
2D Data Matrix
2D QR Code
2D Maxicode (disabled)
2D Aztec (disabled)
Postal: PlanNET (disabled)
Postal: PostNET (disabled)
Postal: Australia (disabled)
Postal: Canadian (disabled)
Postal: Japanese (disabled)
Postal: Kix (disabled)
Postal: Korean (disabled)
Postal: Royal (disabled)

APPENDIX C SCANNER SETTINGS

Barcode Settings	C-3
Scanner Options	C-3
Restoring Default Settings	C-4
Decoded (Internal) Scanners	C-4
Options	C-4
Decoded (Internal) Advanced Options	C-5
Decoded (Internal) Data Options	C-6
Decoded (HHP)	C-7
Decoded (Intermec ISCP).	C-7
Decoded (ISCP) Options	C-7
Decoded (ISCP) Advanced Options	C-7
Non-Decoded Scanners.	C-9
Options	C-9

Barcode Settings

The Scanners icon provides dialog boxes in which you can tailor barcode scanner configurations and choose the barcodes your scanner will recognize.

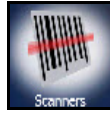

- Tap on **Start>Settings> System>Scanners** icon.

The parameters are preset with the default settings of the decoded scanner installed in the unit.



IMPORTANT

To enable a newly-installed scanner, press and hold down the [FN] key and the [ENTER/Power] key simultaneously for a minimum of three seconds.

For information on configuring the Options, Translations, and Ports settings, see Omnii.

Scanner Options

The drop-down menu to the right of the Scanner option allows you to choose configurations for one of the following scanner types, depending on what is installed in/on your hand-held: Decoded (internal), Decoded (HHP), Decoded (Intermec ISCP), and Non-decoded Scanners.

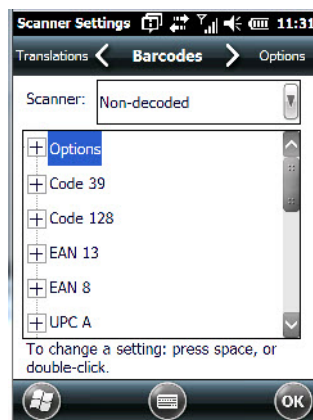

The symbologies listed change to reflect the scanner you choose and the barcodes it supports. Always defer to your barcode scanner's programming manual when in doubt about the availability or settings for any parameter.



NOTE Your Omnii comes preconfigured from the factory for internal scanner types. To determine the type of scanner installed in your unit, go to **Start>Setting>System>System Properties** icon.



IMPORTANT To improve the decode speed and performance, enable (set to 'on') only those codes that are required by the application.

Keep in mind that some barcode types are only available when an internal imaging scanner is installed. All internal scanners can be configured using these dialog boxes.

Restoring Default Settings

If you want to restore the factory defaults after making changes, the defaults can be applied to a selected parameter, sub-tree of parameters, or all scanner parameters.

- Press and hold the stylus on a symbology to display a pop up a menu.

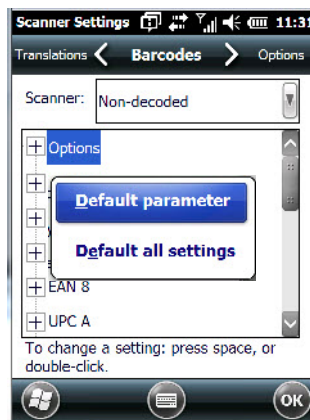

- Choose **Default parameter** to reset only the parameter you selected, or choose **Default all settings** to reset all scanner parameters to default settings.

Decoded (Internal) Scanners

- Tap on the **Scanner** drop-down menu, and choose **Decoded (internal)**.

Options



NOTE Some options are available only for specific scanners. Refer to the option names in this section for scanner model identification.

Dot Time (msec)

The value selected for Dot Time (msec) determines (in milliseconds) how long the targeting dot remains on before the scanner switches to a normal scan sweep. When you double-tap on this parameter, a dialog box is displayed in which you can enter a value of 0 msec, 200 msec or 400 msec. A value of **0** (zero) disables the target dot.

Laser On Time

The value assigned to this parameter determines how long the laser will remain on when the scan button or trigger is pressed.

Double-tapping on this parameter displays a dialog box in which you can enter a value between 5 and 99. The value is measured in tenths of seconds.

Decoded (Internal) Advanced Options

Scan Mode

You can set the method of scanning by setting this parameter to Scan beam only, Aim with Scan: 1 trigger pull, Aim with Scan: 2 trigger pulls, Aim with Scan on trigger release, and Continuous Scan Mode. Default is Scan beam only.

Aim Duration

This parameter determines the total time the aiming pattern appears before the scanner laser begins sweeping. When you double-tap on this parameter, a dialog box is displayed in which you can enter a value from 0 to 30 (0 to 3 sec.). A value of **0** (zero) disables the aiming-dot.

Minimum Cancel Time

The value assigned to this parameter determines the time delay before the scanner is turned off, once the scanner trigger or button is released. This gives the scanner a minimum amount of time to complete its current decode before the scan is cancelled when you quickly trigger on/off.

Power Mode

This parameter is a power-saving option. Tapping on it displays a screen listing two power mode options: Continuous Power and Low Power.

In Continuous Power mode, the scanner is always on, waiting for a trigger pull or serial communication.

In Low Power mode, the scanner is in a standby state, drawing minimal power until a trigger pull or serial communication wakes it. Keep in mind that while this option is more suitable for battery powered applications, there will be a slight delay while the scanner powers up to scan a barcode.

Low Power Timeout

To extend laser life, you can select the time the scanner remains active following a successful decode. The scanner wakes from low power mode when a barcode is scanned — a successful decode restores normal flashing.

This is only used if the unit's Trigger Mode has been changed to Continuous On. If the unit is used in a fixed mount this parameter might be used, but not if the unit is used as a hand-held.

When you double-tap on this parameter, a dialog box is displayed in which you can choose a value of 30 sec., 1 min., 2 min. or 3 min.



NOTE This parameter is only used if the Trigger Mode has been set to Continuous On and Omnii is mounted in a fixed position; otherwise, 'Low Power Timeout' is not used.

Parameter Scanning

Setting this parameter to **on** enables decoding of parameter barcodes.

Linear Security Level

This parameter allows you to select the security level appropriate for your barcode quality. There are four levels of decode security for linear code types (e.g., Code 39, Interleaved 2 of 5). Higher security levels should be selected for decreasing levels of barcode quality. As security levels increase, the scanner's decode speed decreases.

Double-tapping on this parameter displays a dialog box in which you can enter a value from **1** to **4**.

Linear security level **1** specifies that the following code types must be successfully read twice before being decoded:

Codabar	All
MSI Plessey	4 or less
D 5 of 5	8 or less
I 2 of 5	8 or less

Linear security level **2** specifies that all types of codes must be successfully read twice before being decoded.

Linear security level **3** specifies that code types other than the following must be successfully read twice before being decoded. The following codes must be read three times:

MSI Plessey	4 or less
D 2 of 5	8 or less
I 2 of 5	8 or less

Linear security level **4** requires that all code types be successfully read three times before being decoded.

Bi-Direction Redundancy



NOTE This parameter is only valid if a “Linear Security Level” is enabled.

When this parameter is enabled, a barcode must be successfully scanned in both directions (forward and reverse) before being decoded.

Decoded (Internal) Data Options

Transmit Code ID Char

A code ID character identifies the scanned barcode type. In addition to any single character prefix already selected, the code ID character is inserted between the prefix and the decoded symbol.

When you double-tap on this parameter, a dialog box is displayed in which you can choose a transmit code: None, AIM or Symbol.

Scan Data Format

This parameter allows you to change the scan data transmission format.

Double-tapping on **Scan Data Format** displays the following options from which you can choose a data format: data (as-is), data [S1], data [S2], data [S1][S2], [P] data, [P] data [S1], [P] data [S2] and [P] data [S1][S2].

Prefix [P], Suffix [S1] and Suffix [S2]

A prefix and/or one or two suffixes may be appended to scan data for use in data editing. When you double-tap on these parameters, dialog boxes are displayed in which you can enter a value from **0** to **255**.

Delete Char Set ECIs

Setting this parameter to **on** enables the scanner to delete any escape sequences representing Character Set ECIs (Extended Channel Interpretations [also known as GLIs]) from its buffer before transmission.

When this parameter is enabled, the scanner transmits data from PDF417 and MicroPDF417 barcodes containing Character Set ECIs, even when the ECI Protocol is disabled.

ECI Decoder

Setting this parameter to **on** enables the scanner to interpret any Extended Channel Interpretations (ECIs) supported by the scanner. This parameter has no effect on symbols that were not encoded using ECIs.

If this parameter is set to **off** and a symbol that was encoded using an ECI escape is scanned, the scanner transmits the ECI escape followed by the uninterpreted data.

The barcode symbologies for the scanner are listed in the table following.

Decoded (Internal) Barcode Symbologies	
Code 39	UPC/EAN Shared Settings
Trioptic Code (disabled)	Code 93 (disabled)
Code 128	Codabar (disabled)
EAN 13	MSI Plessey (disabled)
EAN 8	Interleaved 2 of 5 (disabled)
UPC-A	Discrete 2 f 5 (disabled)
UPC-E	Gs1 DataBar (disabled)

Decoded (HHP)

To configure imagers, please see [Appendix B: "Imagers Applet"](#).

Decoded (Intermec ISCP)

- Tap on the **Scanner** drop-down menu, and choose **Decoded (Intermec ISCP)**.

Decoded (ISCP) Options

Laser On Time

The value assigned to this parameter determines how long the laser will remain on when the scan button or trigger is pressed.

Double-tapping on this parameter displays a dialog box in which you can enter a value between **1** and **10** seconds.

Decoded (ISCP) Advanced Options

Continuous Scan Mode

Setting this parameter to **on** keeps the laser on and continuously decoding as long as the scanner button is pressed and held down.

Minimum Cancel Time

The value assigned to this parameter determines the time delay before the scanner is turned off, once the scanner trigger or button is released. This gives the scanner a minimum amount of time to complete its current decode before the scan is cancelled when you quickly trigger on/off.

Low Power Timeout

To extend laser life, you can select the time the scanner remains active following a successful decode. The scanner wakes from low power mode when a barcode is scanned — a successful decode restores normal flashing.

When you double-tap on this parameter, a dialog box is displayed in which you can choose a value of 30 sec, 1 min, 2 min, or 3 min.



NOTE This parameter is only used if the Trigger Mode has been set to **Continuous On** and the unit is mounted in a fixed position; otherwise, 'Low Power Timeout' is not used.

Parameter Scanning

Setting this parameter to **Enabled** allows decoding of parameter barcodes.

Same Read Validate

The data is only transmitted after repeated reads give the same result. The value assigned at this parameter determines the number of reads required, from 0 to 10 times.

Same Read Timeout

Prevents the same barcode from being read more than once. The value assigned determines after what time period the scanner will timeout, from 0 to 2550 msec.

Diff Read Timeout

Prevents unwanted reading of other barcodes on the same label. The value assigned determines after what time period the scanner will timeout, from 0 to 2550 msec.

Add AIM ID Prefix

The AIM ID (Association for Automatic Identification and Mobility) is an international barcode identifier. When this parameter is enabled, the AIM ID is inserted at the beginning of the decoded barcode.

The barcode symbologies for the scanner are listed in table following.

Decoded (Intermec ISCP) Barcode Symbologies	
Code 39	TLC-39 (disabled)
Code 128	2D PDF-417
EAN 13	2D micro PDF-417
EAN 8	Discrete 2 of 5 (disabled)
UPC-A	Telepen (disabled)
UPC-E	Gs1 DataBar (disabled)
UPC/EAN Shared Settings	Composite
Code 93 (disabled)	TLC-39 (disabled)
Codabar (disabled)	PDF-417
MSI Plessey (disabled)	micro PDF-417 (disabled)
Code 11 (disabled)	CodaBlock F (disabled)
Interleaved 2 of 5 (disabled)	CodaBlock A (disabled)
Matrix 2 of 5 (disabled)	

Non-Decoded Scanners

- Tap on the **Scanner** drop-down menu, and choose Non-decoded.

All the available barcode symbologies for this type of scanner can be selected in this tab.

A 'plus' sign (+) to the left of the menu item indicates that a sub-menu of parameters is attached.

- Tap on the + sign to display the sub-menu.
- To change a parameter value, double-tap on the parameter. If you need to type a value, a dialog box is displayed in which you can type a new value. If you need to change a yes or no value, double-tapping on the parameter toggles between yes and no.

If you're using the keyboard:

- Highlight the barcode you want to work with, and press the [RIGHT] arrow key to display the sub-menu.
- Use the [UP] and [DOWN] arrow keys to highlight a parameter.
- To change a parameter value, press [SPACE] or the [RIGHT] arrow key. If a field requires text entry, a text box is displayed in which you can enter the appropriate value.

Options

- Tap on the + sign next to Options to display these parameters.

Dot Time (msec)

The value selected for "Dot Time (msec)" determines (in milliseconds) how long the targeting dot remains on before the scanner switches to a normal scan sweep. When you double-tap on this parameter, a dialog box is displayed in which you can enter a value from 0 to 3000. A value of 0 (zero) disables the target dot.

Short Code

When enabled, this parameter allows scanning of short 1 2 of 5 barcodes (2 characters). When disabled, these short barcodes are rejected.

Enabling “Short Code” may reduce the robustness of the decoding since the hand-held must decode more potential barcodes; it is therefore not recommended for general-purpose barcodes with 4 or more characters.

Verify

The value entered for this parameter determines the number of correct additional decodes required after the initial decode, prior to a barcode being accepted. Higher values significantly increase the time it takes to decode a barcode but also improve the reliability of the decoded barcode.

Security

This parameter controls the tolerance for decoding edge-to-edge barcodes (Code 93, Code 128, UPC/EAN). Lower values have a lower tolerance for misreads, but they also increase the time it takes to decode the barcode. The default value of 30 is generally a good compromise setting.

The barcode symbologies for the scanner are listed in table following.

Non-Decoded Barcode Symbologies	
Code 39	Code 93 (disabled)
Code 128	Code 11 (disabled)
EAN 13	Interleaved 2 of 5 (disabled)
EAN 8	MSI Plessey (disabled)
UPC-A	Discrete 2 of 5 (disabled)
UPC-E	IATA 2 of 5 (disabled)
Codabar (disabled)	

APPENDIX D INTERNAL IMAGER & SCANNER SPECIFICATIONS

Internal Scanners and Imagers	D-3
SE955 Scanner	D-3
SE955 Decode Zones	D-3
SE965 Scanner	D-4
SE965 Decode Zones	D-5
SE1224HP - High Performance Scanner	D-6
SE1224HP Decode Zones	D-6
SE1524ER – Extended Range Scanner.	D-7
SE1524ER Decode Zones	D-7
EV15 Imager.	D-8
EV15 Imager Decode Zone	D-8
EA11 Decoded 2D Imager	D-9
EA11 Typical Reading Distances	D-10
EA20X Imager	D-10
EA20X Typical Reading Distances	D-11
HHP 5080SR Imager/Decoder	D-12
HHP 5080SR Working Range	D-12
SE4500SR – Standard Range Imager.	D-13
SE4500SR Decode Zone	D-15
SE4600LR – Long Range Imager	D-16
SE4600LR Decode Zones	D-18

Internal Scanners and Imagers

This appendix lists specifications for the following internal scanners and imagers. For a current list of model numbers and descriptions for Omnii scanner pod and back cover kits, please contact your Zebra representative or go to:

http://www.zebra.com/US-EN/Product+Lines/Psion/?WT.mc_id=psion_us_p_handheld.

SE955 Scanner

Parameter	SE955
Configuration	Decoded
Scan Rate	104 (± 12) scans/sec (bidirectional)
Scan Angle	47° ± 3° default / 35° ± 3° reduced
Voltage	3.0-3.6 V ± 10%; 5 V ± 10%
Ambient Light:	10,000 ft. candles
Laser Safety	IEC 60825
Electrical Safety	UL 60950, EN/IEC 60950
EMI/RFI	FCC Part 15 Class B, EN 55024/CISPR 22, AS 3548, VCCI
Environmental	RoHS Compliant

SE955 Decode Zones

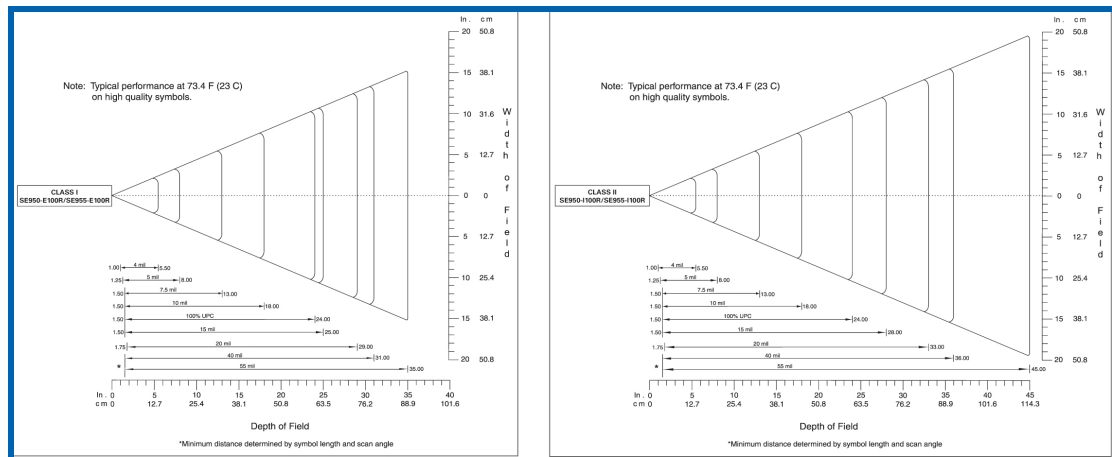

SE965 Scanner

SE965	
Dimensions	0.46 in. H x 0.85 in. W x 0.61 in. D 11.75 mm H x 21.6 mm W x 15.5 mm D
Weight	0.27 oz./7.6 g
Configuration	Decoded
Interface	SSI Control over TTL Serial on a 12-pin ZIF connector
Scan Angle	Wide (default): 47 ° (typical) Medium: 35° (typical) Narrow: 10° (typical) Note: The SE965 scan engine does not require margin on either side of the barcode to decode. The 47° scan line provides identical scanning performance to older scan engines with a scan line of 53°.
Skew Tolerance	± 40° from normal
Pitch Tolerance	± 65° from normal
Roll Tolerance	± 35° from vertical
Specular Dead Zone	± 8°
Optical Resolution	0.005 in. minimum element width
Scan Repetition Rate	104 (± 12) scans/sec (bidirectional)
Print Contrast	Minimum 25% absolute dark/light reflectance measured at 650 nm
Ambient Lighting Tolerance	Tolerant to typical artificial indoor and natural outdoor (direct sunlight) lighting conditions. Fluorescent, Incandescent, Mercury Vapor, Sodium Vapor, LED ⁵ . 450 Ft Candles (4,844 Lux) Sunlight 8000 Ft Candles (86,111 Lux)
Operating Temperature	-22° F to 140° F/ -30° C to 60° C
Storage Temperature	-40° F to 158° F/ -40° C to 70° C

SE965 Decode Zones

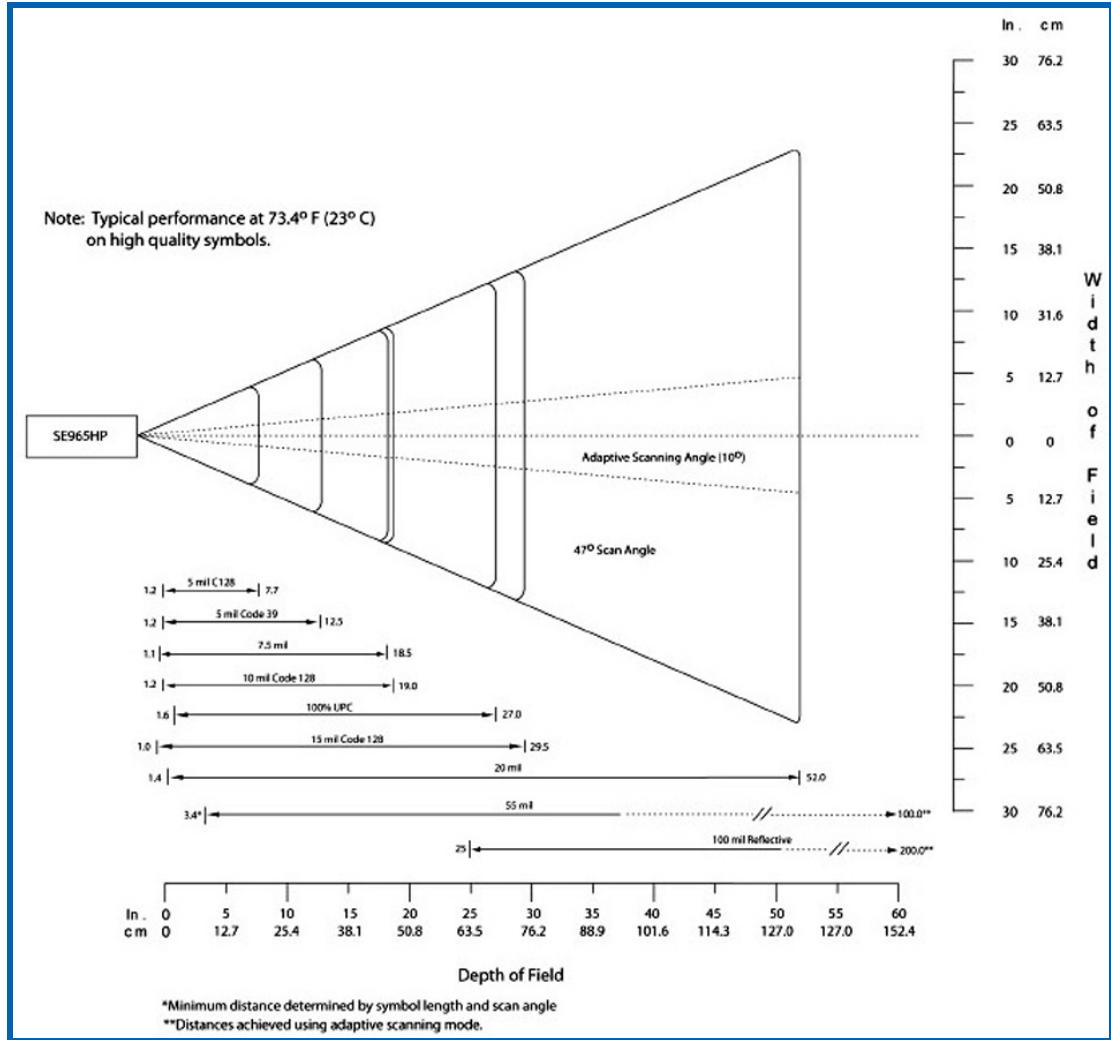

SE1224HP - High Performance Scanner

Parameter	SE1224HP
Type	Laser Class 2
Light Source	Visible Laser Diode 650 nm
Scan Rate	35 (± 5) scans/sec (bi-directional)
Scan Angle/Field of View	42° (typical), 30° (narrow)
Scan Patterns	Linear
Minimum Print Contrast	Minimum 25% absolute dark/light reflectance measured at 650 nm.
Symbologies	UPC/EAN, Code 128, UCC/EAN 128, RSS, Code 39, Code 93, I 2 of 5, Discrete 2 of 5, Codabar, MSI.
Programmable Parameters	Laser On Time, Aim Duration, Power Mode, Trigger Mode, Bi-directional Redundancy, Symbology types/lengths, Data formatting.
Ambient Light	Artificial: 450 ft. candles (4844 Lux). Sunlight: 8000 ft. candles (86112 Lux).
Laser Output Power (peak)	1.35 mW

SE1224HP Decode Zones

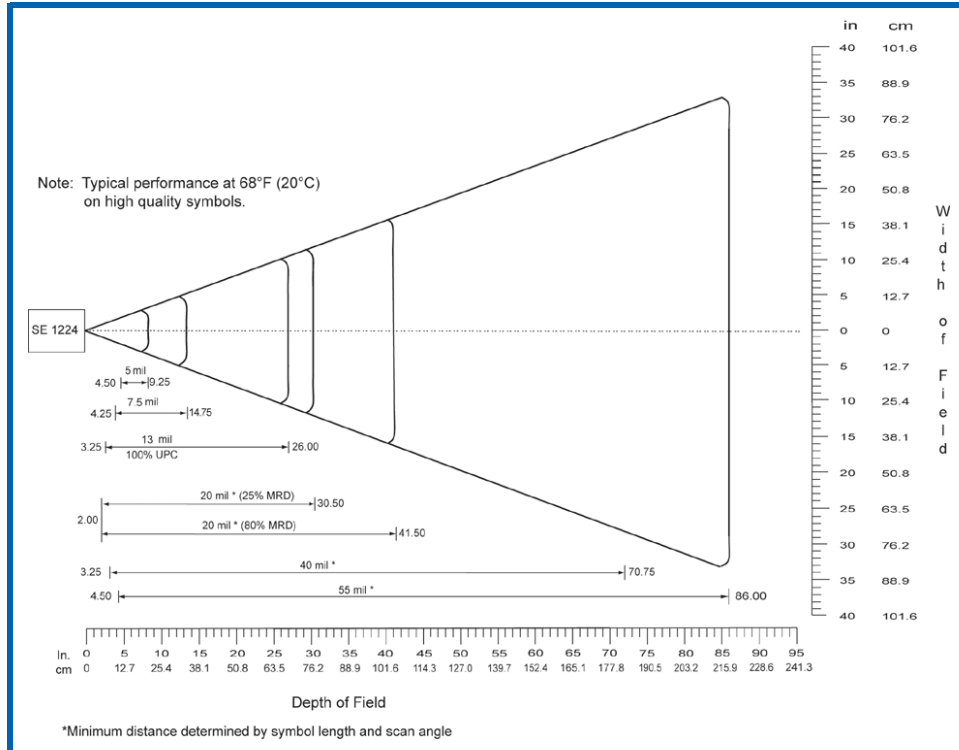

SE1524ER – Extended Range Scanner

Parameter	Specification
Type	Laser Class 2
Light Source	Visible Laser Diode 650 nm
Scan Rate	35 (± 5) scans/sec (bi-directional).
Scan Angle/Field of View	13.5° ± 0.7°
Scan Patterns	Linear
Minimum Print Contrast	Minimum 25% absolute dark/light reflectance measured at 650 nm.
Symbologies	UPC/EAN, Code 128, UCC.EAN128, RSS, Code 39, Code 93, I 2 of 5, Discrete 2 of 5, Codabar, MSI.
Programmable Parameters	Laser On Time, Aim Duration, Power Mode, Trigger Mode, Bi-directional Redundancy, Symbology types/lengths, Data formatting.
Ambient Light	Artificial: 450 ft. candles (4,844 Lux) Sunlight: 4,000 ft. candles (86,112 Lux).
Laser Output Power (peak)	1.26 mW

SE1524ER Decode Zones

SE1524ER Decode Zone A (Short Range, Small Codes)

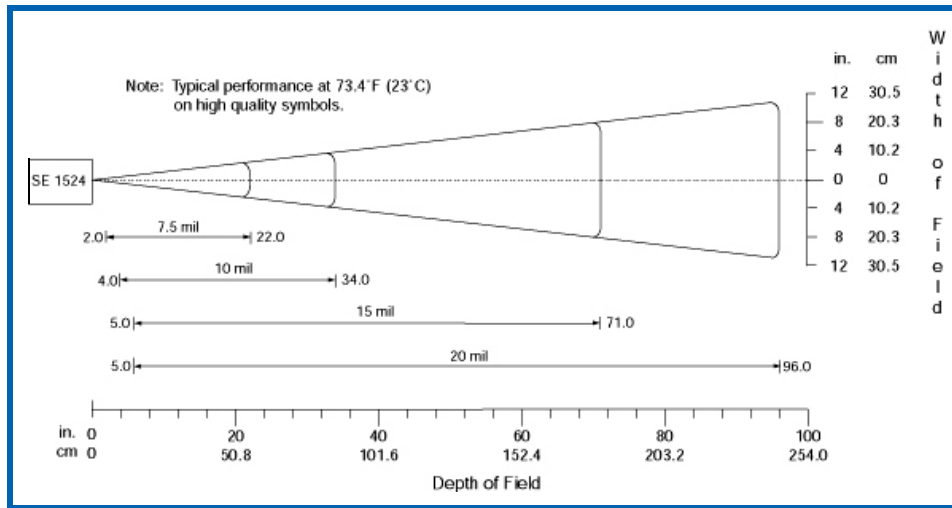

SE1524ER Decode Zone B (Long Range, Large Codes)

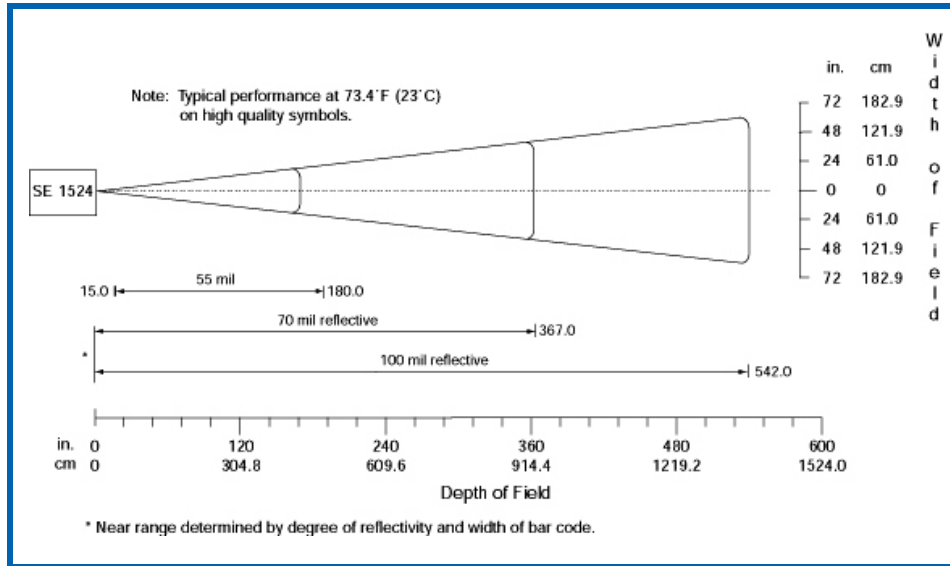

EV15 Imager

Parameter	Specification
Light Source	617 nm highly visible LED
Scan Angle	40°
Minimum Print Contrast	Minimum 25%
Minimum X. Dimension	0.1 mm (4 mils)
Reading Distance	Up to 90 cm (35 in)
Symbologies	UPC (E&A), EAN, RSS, Code 39, Code 128, UCC/EAN 128, ISBN, ISBT, Interleaved, Matrix, Industrial and Standard 2 of 5, Codabar, Code 93/93i, Code 11, MSI, Plessey, Telepen, PDF417, Micro PDF417
Ambient Light	Works in any lighting conditions, from 0 to 100,000 lux

EV15 Imager Decode Zone

0 Lux to 100,000 Lux		
Mil Size	Minimum Range	Maximum Range
	Inches	Inches
5	2.5	7
10	3	14
UPC	2	14.5
20	2.5	22
40	3	35.5
High quality symbols in normal room light.		

EA11 Decoded 2D Imager

Parameter	Specification
Scan Rate	2D mode: 56 images/s auto adaptive
Linear Emulation Mode	200 scans/s auto adaptive
Scan Angle	38.9° (horizontal), 25.4° (vertical)
Optical Resolution	752 (H) x 480 (V) pixels, 256 gray levels
Print Contrast	down to 25%
Versions	Standard range and high density
Symbologies - 1D	EAN/UPC, GS1 Databar (limited expanded & omni-directional), RSS, Code 39, Code 128, UCC/EAN 128, ISBN, ISBT, Interleaved/Matrix/ Industrial and Standard 2 of 5, Codabar, Code 93/93i, Code 11, MSI, Plessey, Telepen, postal codes (Australian Post, BPO, Canada Post, Dutch Post, Japan Post, PostNet, Sweden Post)
Symbologies - 2D	Data Matrix, PDF417, Micro PDF 417, Codablock Maxicode, QR, Aztec GS1 composite codes
Voltage (optics)	3.3V -5% / +10% (typical values)
Operating Current	170mA - 310mA (lighting condition dependent)
Power Saving Mode	2mA
Ambient Light	Works in any lighting conditions, from 0 to 100,000 lux
Regulatory Approvals	UL, VDE certified, RoHS compliant

EA11 Typical Reading Distances

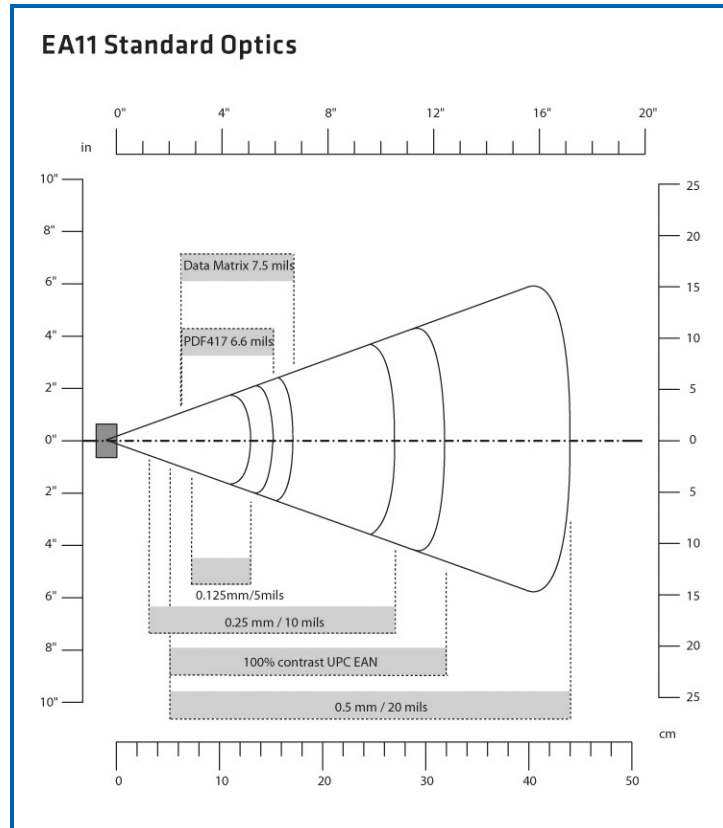

EA20X Imager

Parameter	Specification
Light Source	617nm highly visible LED, 650nm laser framing/aiming
Scan Rate	2D mode: 60 images/s auto adaptive
Linear Emulation Mode	200 scans/s auto adaptive
Scan Angle	26.0° (horizontal), 16.8° (vertical)
Framing Angles	25.0° (horizontal), 16.0° (vertical)
Optical Resolution	752 (H) x 480 (V) pixels, 256 gray levels
Print Contrast	down to 30% on 1D, 35% on 2D
Minimum Resolution	1D symbologies 0.15 mm (6 mil), Stacked (PDF417) 0.17 (6.6 mil) and 2D matrix 0.18 (7mil)
Symbologies - 1D	EAN/UPC, GS1 Databar (limited expanded & omni-directional), RSS, Code 39, Code 128, UCC/EAN 128, ISBN, ISBT, Interleaved/Matrix/Industrial and Standard 2 of 5, Codabar, Code 93/93i, Code 11, MSI, Plessey, Telepen, postal codes (Australian Post, BPO, Canada Post, Dutch Post, Japan Post, PostNet, Sweden Post)
Symbologies - 2D	Data Matrix, PDF417, Micro PDF 417, Codablock Maxicode, QR, Aztec GS1 composite codes
Voltage	3.3V± 5%

Parameter	Specification
Operating Current	410mA @ 3.3V scanning with power save
Power Saving Mode	7mA
Ambient Light	From 0 to 100,000 lux
Regulatory Approvals	UL, cUL, VDE certified, RoHS compliant, Class 2 Laser

EA20X Typical Reading Distances

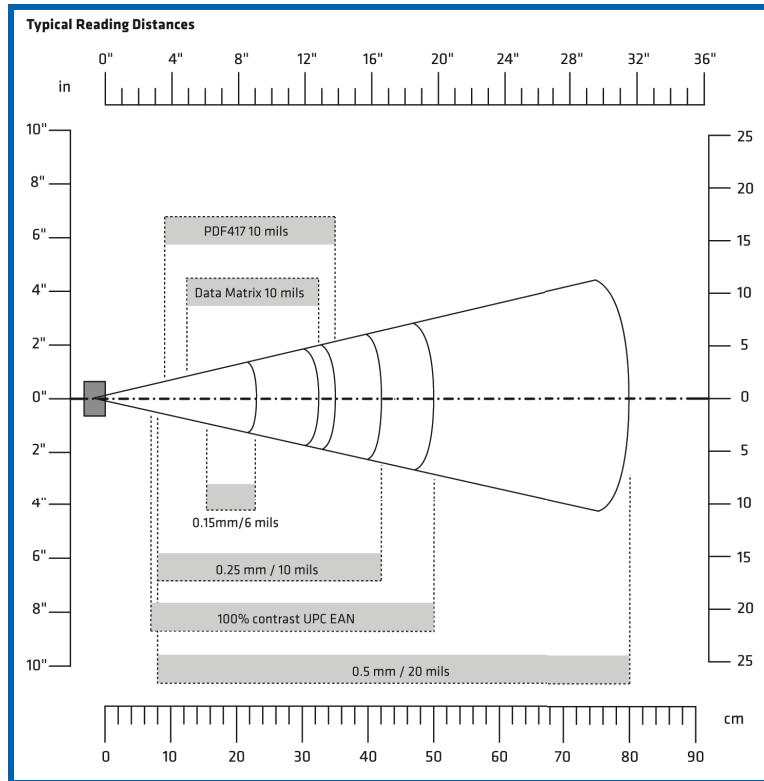

HHP 5080SR Imager/Decoder

Parameter	Specification
Focal Point - SR	7 inches (17.8 cm) from lens plate
Image Sensor	752 x 480 CMOS sensor
Motion Tolerance	4 inches per second
Rotational Sensitivity	360°
Viewing Angle	±40°
Ambient Light	Total darkness to 100,000 lux (full sunlight)
Illumination LEDs	626 nm ± 30 nm
Aiming	LEDs: 526 nm ± 30 nm Laser: 650 nm ± 10 nm
Input Voltage - Imager	3.3 VDC ± 5% (23°C)
Input Voltage - HHP 5080	3.0 VDC to 5.5 VDC (23°C)
Current Draw - Imager	Max. Operating Current: 100 mA; Standby Current: 100 µA
Current Draw - HHP 5080	Average Current (Interlaced Mode): 510 mA; Standby Current: 120 µA; Peak: 600 mA
Symbologies: 2 Dimensional	PDF417, MicroPDF417, MaxiCode, Data Matrix, QR Code, Aztec, Aztec Mesa, Code 49, UCC Composite
Linear	Code 39, Code 128, Codabar, UPC, EAN, Interleaved 2 of 5, Reduced Space Symbology, Code 93, Codablock
Postal	Postnet (US), Planet Code, BPO 4 State, Canadian Post, Japanese Post, KIX (Netherlands) Post

HHP 5080SR Working Range

Data is characterized at 23°C (73.4°F) and 0 lux ambient light.

Symbology	Size (mil)	Near	Far
Linear	8.3 (.020cm)	3.5 in. (8.9cm)	7.6 in. (19.3cm)
PDF417	10 (.025cm)	3.1 in. (7.9cm)	9 in. (22.9cm)
UPC	13 (.033cm)	2.1 in. (5.3cm)	13.2 in. (33.5cm)
Data Matrix	15 (.038cm)	2.3 in. (5.8cm)	10.2 in. (25.9cm)
QR	15 (.038cm)	3.1 in. (7.9cm)	8.8 in. (22.4cm)
MaxiCode	35 (.089cm)	2.0 in. (5.1cm)	13.0 in. (33cm)

SE4500SR – Standard Range Imager

Parameter	Specification
Power Requirements - Input Voltage	3.3 V \pm 0.3 V at 23° C
Operating Mode Supply Currents (conditions VCC=VCC_SENSOR=VCC_ILLUM = 3.3VDC) (at 23° C):	
Low Power	500 μ A
Idle	18 mA
Image Acquisition	80 mA
Illumination Enabled	200 mA
Maximum Operating Current	250 mA (aiming on during exposure, illumination enabled)
Maximum Sensor Power Supply Noise* (at 23° C)	100 mVp-p (3.3 V, 10 Hz - 100 kHz) for decoding 30 mVp-p (3.3 V, 10 Hz - 100 kHz) for image capture
Optical Resolution	SR focus: 5.0 mil (Code 39), 6.7 mil (PDF417)
*For better image quality in image capture applications, use an additional filter on VCC_SENSOR. For additional performance improvement, provide a separately regulated 3.3 V supply for the sensor.	
Specular Dead Zone:	
Illumination On	Up to 20° depending on target distance and substrate glossiness
Illumination Off	None
Skew Tolerance	\pm 60°
Pitch Angle	\pm 60°
Roll	360°
Ambient Light Immunity (Sunlight)	9000 ft. candles (96,900 lux)
Imaging Sensor:	
Image Resolution	752 H x 480 V pixels (Wide VGA)
Grey Scale	256 levels (8 bits per pixel)
Field of View (FOV)	SE4500-SR: 39.6° horizontal, 25.7° vertical
Focusing Distance from Front of Engine (SR)	8 in. / 20.3 cm
Aiming Element:	
Visible Laser Diode (VLD)	655 \pm 10 nm
Central Dot Optical Power	0.6 mW (typical)
Pattern Angle	40° horizontal, 30° vertical
Illumination System:	
LEDs	625 \pm 5 nm (dominant wavelength)
Pattern Angle	60° x 40° at 80% center intensity

Parameter	Specification
Shock	2000 G \pm 5% applied via any mounting surface at -30° and 55° C for a period of 0.85 \pm 0.05 msec 2500 G \pm 5% applied via any mounting surface at 23° C for a period of 0.85 \pm 0.05 msec
Vibration	Unpowered SE4500 withstands a random vibration along each of the X, Y, and Z axes for a period of one hour per axis (6 G rms), defined as follows: 20 to 80 Hz Ramp up at 0.04 G ² /Hz at 3 dB/octave 80 to 350 Hz 0.04 G ² /Hz 350 Hz to 2 kHz Ramp down at 0.04 G ² /Hz at 3 dB/octave
ESD	\pm 2 kV @ connector
Laser Safety Class	CDRH / IEC Class 2
LED Class	IEC Class 1M
Maximum Engine Dimensions	11.8 mm H x 21.50 mm W x 16.3 mm D 0.46 in. H x 0.85 in. W x 0.64 in. D
Weight	8.0 grams (0.28 oz)
Electrical Interface	21 pin 0.3 mm pitch ZIF connector

SE4500SR Decode Zone

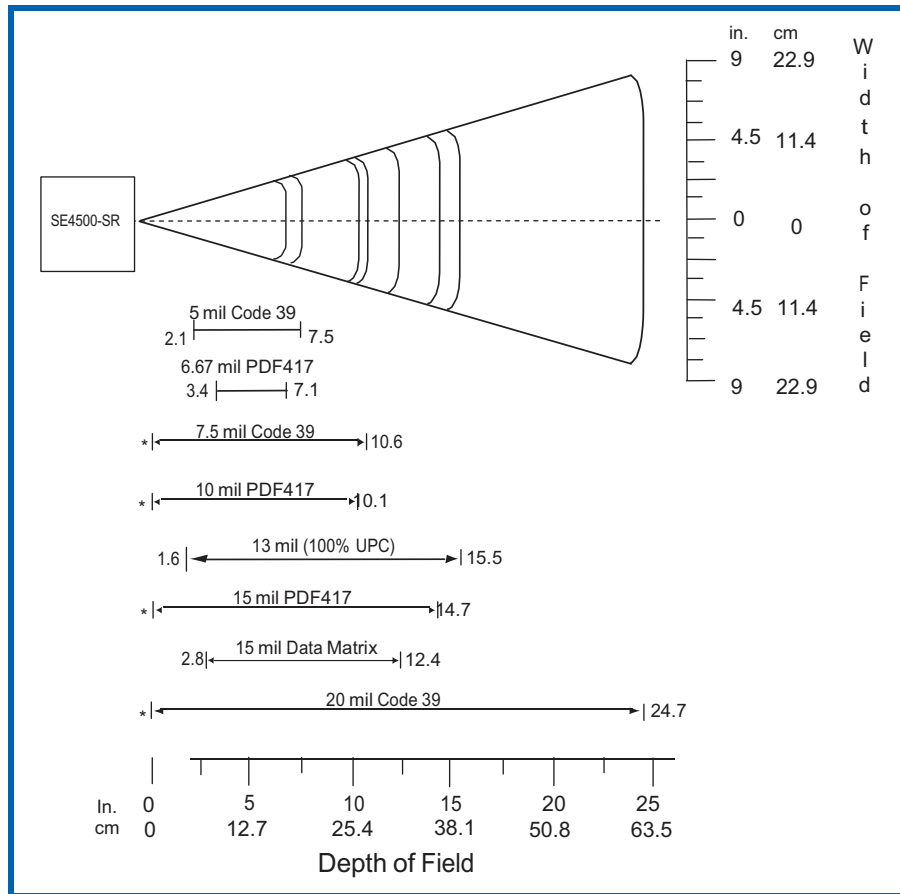

SE4600LR – Long Range Imager

Parameter	Specification
Input Voltages	
VCC	3.3 V \pm 10%, 75 mA max
VCC_INTFC	1.8 V \pm 10% or 3.3 V \pm 10%, 30 mA max
VCC_ILLUM	3.0 V - 8.4 V, 800 mA
VCC_SENSOR	3.3 V \pm 10%, 70 mA max
VCC=VCC_SENSOR=VCC_INTFC =3.3 V VCC_ILLUM=5.0 V	
Operating Mode Supply Currents (Average)	Low Power 750 μ A
Low Power	750 μ A
Idle	20 mA
Aim enabled, no illumination or image acquisition	70 mA
Image Acquisition	
Illumination Enabled	80 mA
Illumination and Aim Enabled	550 mA 600 mA
Maximum Sensor Power Supply Noise* (VCC_SENSOR)	40 mV p-p (10 Hz - 50 KHz) and 100 mV p-p (50KHz - 100 KHz) for bar code decoding 30 mV p-p (10 Hz - 100 KHz) for image capture
Optical Resolution	Near sensor: 5 mil (Code 39), 10 mil (Data Matrix) Far sensor: 15 mil (Code 39), 35 mil (Data Matrix)
Specular Dead Zone:	
Illumination On	Up to 20° depending on target distance and substrate glossiness
Illumination Off	None
Skew Tolerance	\pm 60°
Pitch Angle	\pm 60°
Roll	360°
Ambient Light Immunity (Sunlight)	9000 ft. candles (96,900 lux)
Imaging Sensor:	
Image Resolution	752 H x 480 V pixels (wide VGA)
Grey Scale	256 levels (8 bits per pixel)
Field of View (FOV)	SE4600LR Far System: 11.6° horizontal, 7.4° vertical SE4600LR Near System: 13° horizontal, 8.3° vertical
Aiming Element:	
Visible Laser Diode (VLD)	655 \pm 5 nm (dominant wavelength)
Aiming Dot Optical Power	0.6 mW (typical)

Parameter	Specification
Illumination System:	
LEDs	625 ± 5 nm (dominant wavelength)
Pattern Angle	16° horizontal x 11.5° vertical
Shock	2000 G ± 5% in the direction of any of the six principal axes applied via the mounting surface at -20° and 55° C for a period of 0.85 ± 0.1 msec 2500 G ± 5% in the direction of any of the six principal axes applied via the mounting surface at 23° C for a period of 0.70 ± 0.07 msec
Vibration	Unpowered SE4600LR withstands a random vibration along each of the X, Y, and Z axes for a period of one hour per axis (6 G rms), defined as follows: 20 to 80 Hz Ramp up at 0.04 G ² /Hz at 3 dB/octave 80 to 350 Hz 0.04 G ² /Hz 350 Hz to 2 kHz Ramp down at 0.04 G ² /Hz at 3 dB/octave
ESD	± 2 kV @ connector
Laser Safety Class	CDRH / IEC Class 2
LED Class	IEC Class
Temperature:	
Operating	-20° to 55° C (-4° to 131° F)
Storage	-40° to 70° C (-40° to 158°F) (-30° C (22° F) for Omnii XT15f Arctic variant)
Humidity:	
Operating	95% RH, non-condensing at 55° C
Storage	85% RH, non-condensing at 70° C
Maximum Engine Dimensions	38.23 mm W x 19.34 mm H x 27.00 mm D 1.51 in. W x 0.76 in. H x 1.06 in. D
Weight	45 - 52 grams (1.59 - 1.83 oz)
Electrical Interface	27 pin 0.3 mm pitch ZIF connector
NOTE: Environmental and/or tolerance parameters are not cumulative. A thermal analysis is recommended if the application is subject to an extreme temperature environment.	

SE4600LR Decode Zones

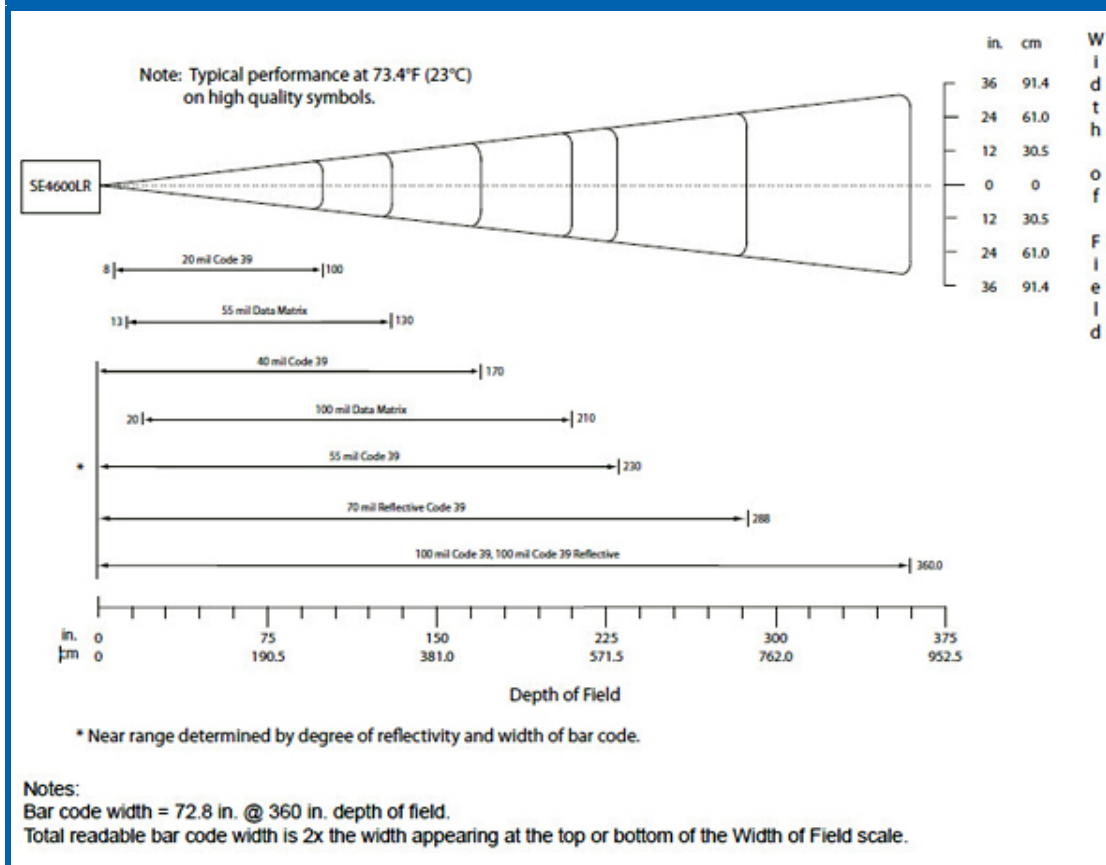
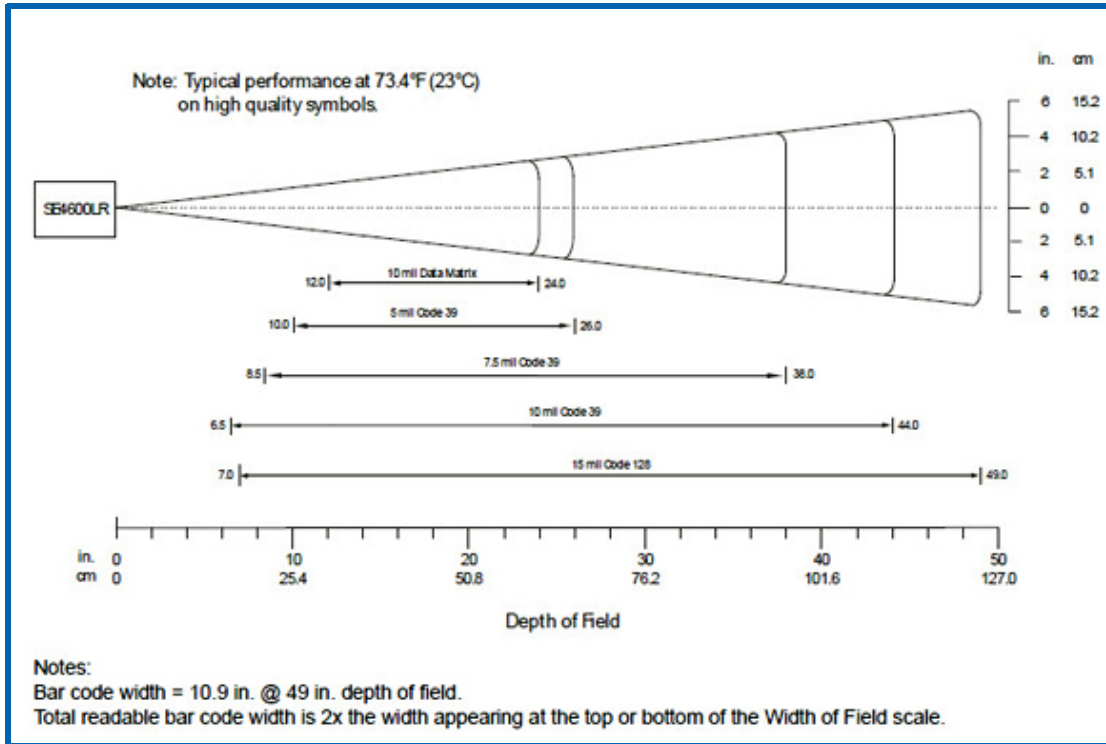

APPENDIX E OMNII SPECIFICATIONS

The Omnia Hand-Held Computer (Model 7545)	E-3
Hardware	E-3
Regulatory Approvals	E-5
Lithium-ion Smart Battery 5000 mAh (ST3001)	E-5
Wireless Radios	E-6
Cinterion, Model MC75i GSM/GPRS/EDGE Radio	E-6
Cinterion PH8-P GSM/GPRS/EDGE/UMTS/HSPA+ Radio	E-7
802.11a/b/g/n Radio	E-9
Bluetooth Radio	E-11

The Omni Hand-Held Computer (Model 7545)



NOTE For Omni freezer unit hardware specifications, please go to Appendix F: "Omni XT15f Freezer Unit (Model 7545XT)".



NOTE Performance specifications are nominal and subject to change without notice.

Hardware

Physical Dimensions

Width

- At display: 100 mm (3.94 in)
- At docking connector: 45 mm (1.77 in)

Depth

- At display: 44 mm (1.73 in)
- At docking connector: 45 mm (1.77 in)

Weight

- Basic unit with battery: 610g (1.34 lb)
- With battery, high visibility display, camera, Push-To-Talk speaker, EV15 1D imager: 636g (1.40 lb)

Processor and Memory

- Texas Instruments® AM3715 Sitara (OMAP3® compatible), ARM Processor 800 MHz.
- RAM: 512 MB.
- Flash ROM: 1 GB.

Operating System

- Microsoft Windows® Embedded Hand-Held 6.5

User Interface

- Colour/Touch Display: 9.4 cm (3.7 in) diagonal.
- VGA (640 x 480) Transflective.
- High Visibility option: superior sunlight visibility with 165 cd/m2 brightness.
- Extreme Duty option: withstands 1.25 Joule impact, superior low temperature operation (to -20° C/-4° F), with 160 cd/m2 brightness. Better abrasion resistance.
- Keyboards: High reliability keypad ultra-white backlight.
- Large selection of both alpha and numeric formats. See: http://www.zebra.com/US-EN/Product+Lines/Psion/?WT.mc_id=psion_us_p_handheld for a list of available configurations.
- Indicators and Controls: Four multi-colour LEDs indicate the status of the battery, application, radio, and scanner.
- Side Buttons: Volume, Scan, Enter, Vertical Scroll.
- Voice, Audio & Feedback: High volume beeper: 95 dBA.

- Integrated microphone and speaker.
- Optional Push-to-Talk speaker.
- Walkie-talkie style Push-to-Talk – VoIP over Wi-Fi or WWAN.
- Vibration feedback.

Power Management

- Battery Pack: 5000 mAh high capacity Lithium-ion (for battery specifications, see [“Lithium-ion Smart Battery 5000 mAh \(ST3001\)”](#) on page E-5).

Communication

- Expansion Ports: MicroSD slot for Flash expansion (up to 32 GB).
- Multiple Internal Multi-Function Expansion Interfaces with: TTL serial, USB host, GP10

Camera (optional)

- Colour.
- 3 Megapixel.
- Autofocus.
- 4x digital zoom.
- Dual LED flash.
- Video capable.

Enhanced Features

- 3 axis accelerometer.
- Compass.
- GPS.

Environmental

- Operating Temperature: -20°C to +50°C (-4°F to +122°F)
- Storage Temperature: -40°C to +60°C (-40°F to +140°F)
- Humidity: 5% to 95% RH non-condensing.
- ESD: +/- 8 kV contact, +/- 15 kV air discharge.
- Omnii RT15 Drop Durability:
1.5 m (5 ft.), 26 drops to polished concrete (powered on, with accessories); multiple 1.8 m (6 ft.) drops to polished concrete.
Rain And Dust Resistance: IEC 60529, classification IP65.
- Omnii XT15 Drop Durability:
1.7 m (5.6 ft.), 26 drops to polished concrete (powered on, with accessories); multiple 2.0 m (6.5 ft.) drops to polished concrete.
Rain And Dust Resistance: IEC 60529, classification IP67.

Regulatory Approvals

- Worldwide Safety, EMC, RF, Laser approvals
- CE Mark
- E Mark (vehicle cradles)
- RoHS compliant
- WEEE compliant
- REACH compliant

Lithium-ion Smart Battery 5000 mAh (ST3001)

For safety instructions, please see "Lithium-ion Battery Safety Precautions" in the Omni Hand-Held Computer Regulatory & Warranty Guide (PN 8000191).

Parameter	Specification
Model Number	ST3001
Chemistry	lithium-ion (Li-Ion)
Capacity	5000 mAh nominal at 1000 mA discharge 20°C to 3.0 V (min)
Voltage	3.7 V nominal (3.0 V min. to 4.2 V max.)
Cell Configuration	1S2P (2 parallel connected cells)
Max. Charge Voltage	4.2 V +/- 1%
Recommended Charge Termination Timeout	5.0 hr - charging must stop.
Charge Temperature	0°C to +40°C (32°F to +104°F)
Discharge Temperature	-20°C to +50°C (-4°F to +122°F)
Storage Temperature	-20°C to +50°C (-4°F to +122 °F). Storage at elevated temperatures not recommended. 25°C (77 °F) — recommended storage temperature.
Cycle Life	300 cycles minimum with no degradation below 70% of nominal capacity based on 0.5C charge / 0.5C discharge rates (to 3.0 V) @ 23°C (73.4 °F).

Wireless Radios

Cinterion, Model MC75i GSM/GPRS/EDGE Radio

Parameter	Specification
Manufacturer	Cinterion, Model MC75i
Form Factor	Quad-Band GSM 850/900/1800/1900 MHz EDGE (E-GPRS) multi-slot class 12 GPRS multi-slot class 12 GSM release 99
Output Power	Class 4 (2 W) for EGSM850 Class 4 (2 W) for EGSM900 Class 1 (1 W) for GSM1800 Class 1 (1 W) for GSM1900
Control via AT Commands	Hayes, 3GPP TS 27.007 and 27.005
Supply Voltage Range	3.2 to 4.3 V
EDGE Data Transmission	EDGE class 12: max 236.8 kbps (downlink) Mobile station class B Modulation and coding scheme MCS 1-9
GPRS Data Transmission	GPRS class 12 Mobile station class B PBCCH support Coding schemes CS 1-4

Parameter	Specification
CSD Data Transmission	Up to 14.4 kbps, V.110 Non-transparent mode
SMS	Point-to-point MO and MT Text and PDU mode
Voice	Triple-rate codec for HR, FR, and EFR Adaptive multi-rate AMR Basic hands-free operation Echo cancellation Noise reduction
Interfaces	Hirose U.FL-R-SMT 50 ohm antenna connector Antenna solder pad Molex 80-pin board-to-board connector: -Power supply - Audio: 2x analog, 1x digital - Serial interface (ITU-T V.24 protocol) - SIM card interface 3 V, 1.8 V

Cinterion PH8-P GSM/GPRS/EDGE/UMTS/HSPA+ Radio

Parameter	Specifications
General	
Frequency bands	GSM/GPRS/EDGE: Quad band, 850/900/1800/1900MHz UMTS/HSPA+: Five band, 800/850/900/1900/2100MHz
GSM class	Small MS
Output power (according to Release 99)	Class 4 (+33dBm ±2dB) for EGSM850 Class 4 (+33dBm ±2dB) for EGSM900 Class 1 (+30dBm ±2dB) for GSM1800 Class 1 (+30dBm ±2dB) for GSM1900 Class E2 (+27dBm ±3dB) for GSM 850 8-PSK Class E2 (+27dBm ±3dB) for GSM 900 8-PSK Class E2 (+26dBm +3 /-4dB) for GSM 1800 8-PSK Class E2 (+26dBm +3 /-4dB) for GSM 1900 8-PSK Class 3 (+24dBm +1/-3dB) for UMTS 2100, WCDMA FDD Bd I Class 3 (+24dBm +1/-3dB) for UMTS 1900, WCDMA FDD Bd II Class 3 (+24dBm +1/-3dB) for UMTS 900, WCDMA FDD Bd VIII Class 3 (+24dBm +1/-3dB) for UMTS 850, WCDMA FDD Bd V Class 3 (+24dBm +1/-3dB) for UMTS 800, WCDMA FDD Bd VI

Parameter	Specifications
HSPA features	
3GPP Release 6, 7	DL 14.4Mbps, UL 5.7Mbps UE CAT. [1-6], 11, 12 supported Compressed mode (CM) supported according to 3GPP TS25.212
UMTS features	
3GPP Release 4	PS data rate - 384 kbps DL / 384 kbps UL CS data rate - 64 kbps DL / 64 kbps UL
GSM/GPRS/EGPRS features	
Data transfer	<p>GPRS:</p> <ul style="list-style-type: none"> • Multislot Class 10 • Full PBCCH support • Mobile Station Class B • Coding Scheme 1 - 4 <p>EGPRS:</p> <ul style="list-style-type: none"> • Multislot Class 10 • EDGE E2 power class for 8 PSK • Downlink coding schemes - CS 1-4, MCS 1-9 • Uplink coding schemes - CS 1-4, MCS 1-9 • SRB loopback and test mode B • 8-bit, 11-bit RACH • PBCCH support • 1 phase/2 phase access procedures • Link adaptation and IR • NACC, extended UL TBF • Mobile Station Class B <p>CSD:</p> <ul style="list-style-type: none"> • V.110, RLP, non-transparent • 14.4kbps • USSD
SMS	Point-to-point MT and MO
GPS features	
Protocol	NMEA
Modes	Assisted GPS (control plane AGPS, E911)

Parameter	Specifications
General	Power saving modes GPS tracking in parallel to 2G/3G diversity operation
Software	
AT commands	Hayes, 3GPP TS 27.007 and 27.005, and proprietary Cinterion Wireless Modules commands
SIM Application Toolkit	SAT Release 99
Audio	Audio speech codecs GSM: AMR, EFR, FR, HR 3GPP: AMR Speakerphone operation, echo cancellation, noise suppression
Interfaces	
Antenna	50Ohms. Main GSM/UMTS antenna, UMTS diversity antenna, GPS antenna (active/passive)
USB	USB 2.0 High Speed (480Mbit/s) device interface
UICC interface	Supported chip cards: UICC/SIM/USIM 3V, 1.8V
Special features	
Phonebook	SIM and phone
Antenna	SAIC (Single Antenna Interference Cancellation) / DARP (Downlink Advanced Receiver Performance) RX diversity type 3i

802.11a/b/g/n Radio

Parameter	Sub-parameter	Specification
Manufacturer		Murata, Model LBEH1Z9PFC
Form Factor		Embedded surface mount module, 11.4 x 9.4 mm * This is a combo module containing both Wi-Fi 802.11a/b/g/n and Bluetooth V2.1+EDR radio
Antenna Port	802.11b/g/n	U.FL jack. Non-diversity. Multiplexed between 802.11b/g/n (2.4GHz) and Bluetooth radio
	802.11a/n	U.FL jack. Non-diversity.
Antenna Type	802.11b/g/n	PCB substrate patch antenna. Covers 2400-2484 MHz @ <2.5:1 VSWR
	802.11a/n	PCB substrate patch antenna. Covers 5150-5860 MHz @ <2.5:1 VSWR
Antenna Gain	802.11b/g/n	1.9 dBi
	802.11a/n	1.9 dBi

Parameter	Sub-parameter	Specification
Transmit Power	802.11b	+18 dBm typical, +19.5 dBm max
	802.11g	+13 dBm typical, +14.5 dBm max
	802.11a	+12 dBm typical, +13.5 dBm max
	802.11n (2.4 GHz)	+12 dBm typical, +13.5 dBm max
	802.11n (5 GHz)	+12 dBm typical, +13.5 dBm max
Frequency Range	802.11b/g/n	2400-2483.5 MHz
	802.11a/n	5150-5350 MHz, 5480-5720 MHz and 5725-5845 MHz
Channels	802.11b/g/n	1 to 14. Up to 14 channels (depending on country). Only 3 channels are non-overlapping.
	802.11a/n	36, 40, 44, 48, 52, 56, 60, 64 100, 104, 108, 112, 116, 120, 124, 128, 132, 136, 140 149, 153, 157, 161, 165 Up to 24 channels (depending on country). All channels are non-overlapping.
RX Sensitivity	802.11b	-78 dBm @ 11 Mbps
	802.11g	-67 dBm @ 54 Mbps
	802.11a	-67 dBm @ 54 Mbps
	802.11n (2.4 GHz)	-66 dBm @ 65 Mbps
	802.11n (5 GHz)	-66 dBm @ 65 Mbps
Data Rates	802.11b	1,2,5.5,11 Mbps
	802.11a/g	6,9,12,18,24,36,48,54 Mbps
	802.11n	6.5,13,19.5,26,39,52,58.5,65 Mbps
EVM	802.11b	32% max
	802.11g	-26 dB max
	802.11a	-26 dB max
	802.11n (2.4 GHz)	-29 dB max
	802.11n (5 GHz)	-29 dB max
Bluetooth Coexistence		TI Wilink6 proprietary Wi-Fi-BT co-existent scheme.

Bluetooth Radio

Parameter	Specification
Manufacturer	Murata, Model LBEH1Z9PFC
Form Factor	Embedded surface mount module, 11.4 x 9.4 mm * This is a combo module containing both Wi-Fi 802.11a/b/g/n and Bluetooth V2.1+EDR radio
Antenna Port	U.FL jack (shared with Wi-Fi 802.11b/g/n radio)
Antenna Type	PCB substrate patch antenna. Covers 2400-2484 MHz @ <2.5:1 VSWR
Antenna Gain	1.9 dBi
Transmit Power	6.5 dBm typical, 8.5 dBm max
Frequency Range	2.400-2.4835 GHz
Channels	79
RX Sensitivity	-90 dBm typical, -70 dBm max
Data Rates	V1.2=732.2 kbps and 57.6 kbps asymmetric, 433.9 kbps symmetric V2.0=2 & 3 Mbps
802.11 Coexistence	TI Wilink6 proprietary Wi-Fi-BT co-existent scheme.

CHAPTER FOMNII XT15F FREEZER VARIANTS

The Omnii XT15f Hand-Held Computer (Model 7545XT)	F-3
Hardware Specifications.	F-4
Regulatory Approvals	F-5
The Freezer Keyboards	F-6
Lithium-ion Smart Battery 5000 mAh (ST3001) for Omnii Chiller Model	F-6
Lithium-ion Smart Battery 5300 mAh (ST3002) for Omnii Arctic Model	F-7
Quick Defrost Application	F-8
Settings	F-9
Suspend Threshold	F-9
Scan Window	F-9
Heater Info	F-9
Heater System	F-10
Display and Scan Window Heaters	F-11
System Test.	F-11
System Properties	F-12

The Omnii XT15f Hand-Held Computer (Model 7545XT)

i **NOTE** Performance specifications are nominal and subject to change without notice.

The Omnii XT15f is a modular, industrial hand-held computer suitable for cold chain and extreme weather environments. These units are equipped with heating hardware to prevent condensation from developing on or inside the Omnii.

Two variants are available – the Chiller and the Arctic. The Chiller model is condensing-resistant, and the Arctic model is condensing-free. This variant is equipped with a heated scanner window and a standard 5000 mAh battery (model number ST3001). An optional freezer battery (model number ST3002) can be ordered for the Chiller variant. The Omnii Arctic freezer variant is equipped with an optically bonded heated display module, providing a condensation-free unit. It is only available with an ST3002 freezer battery.

i **NOTE** The Omnii Hand-Held Computer is a body worn device, and to maintain compliance with the FCC RF exposure guidelines, use a Zebra approved carrying case. Use of non-approved accessories may violate FCC RF exposure guidelines.

Model Variants

- Omnii XT15f Arctic Hand-Held Computer (extremely rugged, condensing-free) - Model 7545XT. This model features a multi-core heater control logic board that dynamically heats the scan window and LCD display.
- Omnii XT15f Chiller Hand-Held Computer (extremely rugged, condensing-resistant) - Model 7545XT. This model features a single core heater control logic board dynamically heats the scan window.

Figure F-1 Omnii XT15f Freezer Variants



Hardware Specifications

Physical Dimensions

- Length: 226 mm (8.89 in)
- Width: At display: 98 mm (3.86 in)
- Depth: At display: 82 mm (3.2 in)
At grip area: 31 mm (1.22 in)
- Weight: 834 g (1.8 lb) with SE965HP laser, ST3002 battery, and pistol grip

Barcode Scanner Options



NOTE Both Arctic and Freezer variants include a heated scan window for Frost Free Scanning (FFS).

- SE965HP 1D Standard Range Laser
- SE1524ER 1D Extended Range Laser
- SE4600LR 2D Long Range Imager

Display

- 3.7" VGA (640 x 480) Transflective Color/Touch Display

Chiller Variant:

- Extreme Duty, designed for rugged environments with improved impact resistance (1.25 Joule impact), better abrasion resistance, superior low temperature operation (to -20°C / -4°F), with 160 cd/m² brightness.

Arctic Variant:

- Extreme Duty, designed for rugged environments with improved impact resistance (1.25 Joule impact), better abrasion resistance, superior low temperature operation (to -30°C / -22°F), with 160 cd/m² brightness.
- The optically bonded display module prevents the build-up of condensation/fogging between the display and the touchscreen.
- The display heater is responsible for maintaining a acceptable refresh rate in extreme cold environments.

Keyboard

- Both variants include specially designed keyboards that resist freezing due to ice build-up in condensing environments.
- 58-key full alphanumeric with 6 single-push Function keys.
- 34-key numeric with 12 single-push Function keys.

Power Management

- Chiller Battery Pack: 5000 mAh high capacity Lithium-ion.
Optional 5300mAh high capacity smart freezer battery with specialized low temperature chemistry.
- Arctic Battery Pack: 5300 mAh high-capacity Lithium-ion smart freezer battery with specialized low temperature chemistry.



WARNING Powered cradles are designed to allow the Omni to be powered by a vehicle battery. The battery installed in the Omni is also recharged by the vehicle battery. This option accepts DC power sources over the range 11.5V to 30V.

For Omni XT15f Chiller units, voltages above that require the use of the power preregulator Model No. PS1350. However, Omni XT15f Arctic units operating in temperatures from -30°C to +50°C, require the use of the power preregulator Model No. PS1370.

For detailed information, see [“ST1002 Powered Cradle Installation” on page 5-22](#)

Environmental

Chiller Variant:

- Operating Temperature: -20°C to +50°C (-4°F to +122°F)
- Storage Temperature: -40°C to +60°C (-40°F to +140°F)
- Humidity: 5% to 95% RH non-condensing (Condensation-Resistant).
- Rain/Dust: Dual IP rating: IP67 and IP65 (IEC 60529)
- Drop Rating: Multiple 2 m (6.5 ft) drops to polished concrete
- ESD: +/- 8 kV contact, +/- 15 kV air discharge.

Arctic Variant:

- Operating Temperature: -30°C to +50°C (-22°F to +122°F)
- Storage Temperature: -40°C to +60°C (-40°F to +140°F)
- Humidity: Condensing (Condensation-Free using internal heaters).
- Rain/Dust: Dual IP rating: IP67 and IP65 (IEC 60529)
- Drop Rating: Multiple 2 m (6.5 ft) drops to polished concrete
- ESD: +/- 8 kV contact, +/- 15 kV air discharge.

Regulatory Approvals

- Worldwide Safety, EMC, RF, Laser approvals
- CE Mark
- E Mark (vehicle cradles)
- RoHS compliant
- WEEE compliant
- REACH compliant

The Freezer Keyboards

Two keyboard layouts are available for the Chiller and Arctic hand-held units. Both variants include specially designed keyboards that resist freezing due to ice build-up in condensing environments.

Figure F-2 Freezer Keyboard Layouts

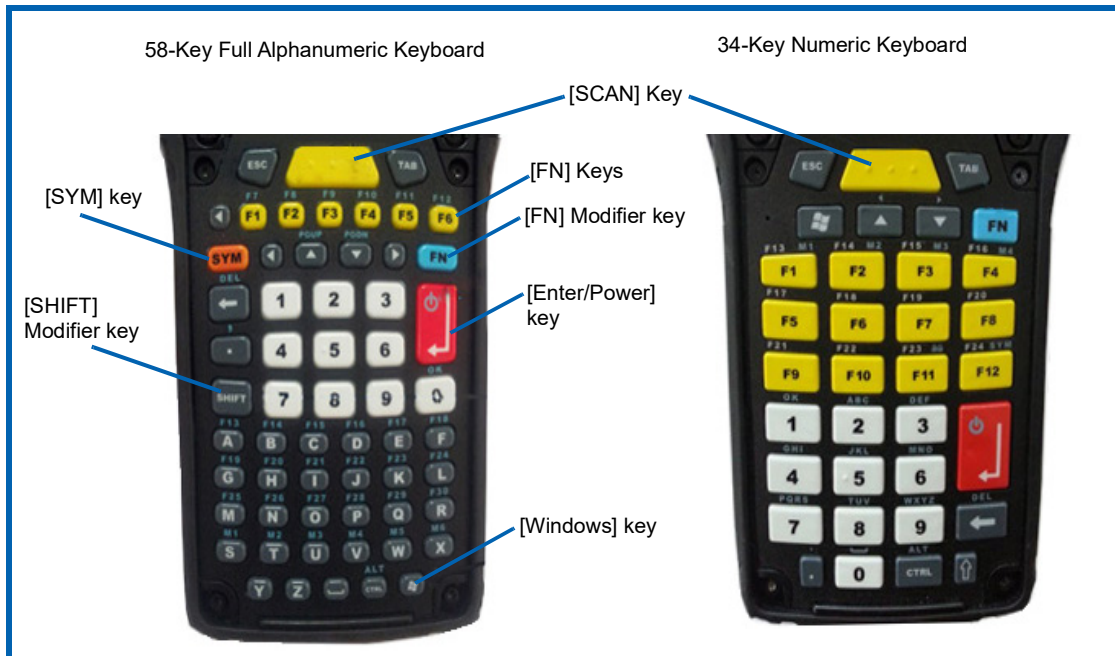

Lithium-ion Smart Battery 5000 mAh (ST3001) for Omnii Chiller Model

The Omnii Chiller model is shipped with the standard ST3001 Lithium-ion Smart Battery. The ST3002 Arctic battery is available as an option. See [Lithium-ion Smart Battery 5300 mAh \(ST3002\) for Omnii Arctic Model on page F-7](#) for information about this battery.

For safety instructions, refer to Omnii Hand-Held Computer Regulatory & Warranty Guide (PN 8000191).

Parameter	Specification
Model Number	ST3001
Chemistry	Lithium-ion (Li-Ion)
Capacity	5000 mAh nominal at 1000 mA discharge 20°C to 3.0 V (min)
Voltage	3.7 V nominal (2.75 V min. to 4.2 V max.)
Cell Configuration	1S2P (2 parallel connected cells)
Max. Charge Voltage	4.2 V +/- 1%
Recommended Charge Termination Timeout	5.0 hr - charging must stop.

Parameter	Specification
Charge Temperature	0°C to +40°C (32°F to +104°F)
Discharge Temperature	-20°C to +50°C (-4°F to +122°F)
Storage Temperature	-20°C to +50°C (-4°F to +122 °F). Storage at elevated temperatures not recommended. 25°C (77 °F) — recommended storage temperature.
Cycle Life	300 cycles minimum with no degradation below 70% of nominal capacity based on 0.5C charge / 0.5C discharge rates (to 3.0 V) @ 23°C (73.4 °F).

Lithium-ion Smart Battery 5300 mAh (ST3002) for Omnia Arctic Model



NOTE This battery model is not restricted to the Omnia Arctic variant. It can be ordered as an option for the Omnia Chiller variant.

The Omnia Arctic model is shipped with the Arctic ST3002 Lithium-ion Smart Battery.

For safety instructions, see “Lithium-ion Battery Safety Precautions” in the Omnia Hand-Held Computer Regulatory & Warranty Guide (PN 8000191).

Parameter	Specification
Model Number	ST3002
Chemistry	Lithium-ion (Li-Ion)
Capacity	5300 mAh nominal at 1000 mA. Discharge @ 20°C to 2.75 V (min)
Voltage	3.6 V nominal (2.75 V min. to 4.2 V max.)
Cell Configuration	1S2P (2 parallel connected cells)
Max. Charge Voltage	4.2 V +/- 1%
Recommended Charge Termination Timeout	5.0 hr - charging must stop.
Charge Temperature	0°C to +40°C (32°F to +104°F)
Discharge Temperature	-30°C to +50°C (-22°F to +122°F)
Storage Temperature	-20°C to +50°C (-4°F to +122°F). Storage at elevated temperatures not recommended. 25°C (77°F) — recommended storage temperature
Cycle Life	300 cycles minimum with no degradation below 70% of nominal capacity based on 2.5A - 4.20V charge / 2.5A - 2.75V discharge rates @ 25°C (77°F).

Figure F-3 Arctic Freezer Battery and Safety Label



Quick Defrost Application

The Omnii XT15f is a freezer capable hand-held computer with integrated heaters designed to improve the functionality and operation of the hand-held device in extreme cold environments. The Arctic variant has two heaters; one for the display and one for the scanner window. The Chiller variant has only one heater which is located on the scanner window. The Quick Defrost application is the nerve center of the heater related information. The Setting tab allows the configuration of the suspend time of the heating system along with the scanner window power setting. The Heater Info tab provide instantaneous heater information for each individual heater and the overall heating system. For environmental specifications for this computer, see “[Hardware Specifications](#)” on page F-4.

To ensure proper operation of the hand-held device in a freezer environment, the surface temperature is managed by the heating system to prevent the formation of external/internal condensation on critical modules. The heating system consists of two heating elements; one for the display and one for the scan window.

Quick Defrost Settings

The individual heaters for the computer modules can be monitored, and the duration of time for them to remain on during Suspend mode can be configured.

- Tap on **Start>Settings>System**.

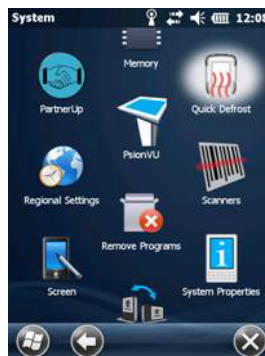

- Tap on the **Quick Defrost** icon.



Settings

The Quick Defrost application opens in the Settings tab.

Suspend Threshold

The Suspend Threshold option allows you to maintain heat for a limited time when the computer enters Suspend mode. Once the threshold is reached, the heater will stay off while the computer is in suspend.

- To set the time, slide the trackbar to the desired time and click **OK**. Values range from 0 to 5 minutes.

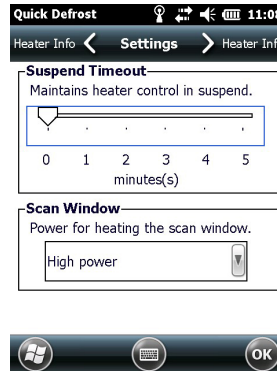

i **NOTE** Keep in mind that a longer suspend threshold will reduce the overall battery shift life.

Scan Window

The Scan Window option allows the user to set the power level for the periphery scan window heater. There are two pull down options:

High power (default): This heating profile is designed for users who are in and out of the freezer frequently (with a freezer dwell time of less than 20 minutes). This heating profile keeps a constant positive temperature on the scan window, eliminating external and/or internal condensation from frequent transitions.

i **NOTE** Keep in mind that this heating algorithm provides additional power at the expense of the battery shift life.

Low power: This heating profile is designed for users who spend long durations in the freezer environment. It is a less aggressive algorithm, compared to the High power mode, that maximizes battery shift life. This profile addresses the formation of internal condensation to keep the scan window clear of condensation.

These two scan window power modes can be adjusted on the fly, providing the user with the needed flexibility for optimal performance.

Heater Info

- In the Quick Defrost dialog box, open the **Heater Info** tab. This dialog box allows you to monitor the status of each heater and test the entire system.

Temperature Selection

You have the option of setting the display temperatures to Celsius or Fahrenheit.

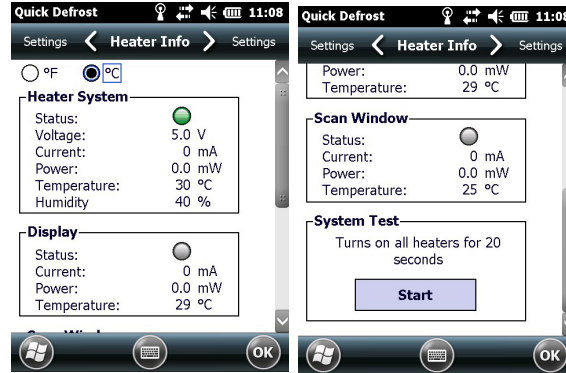

Heater System

This section displays information on the heater system.

Status (Individual Heaters)

The LED state for this parameter indicates whether or not communication between the Omnii main system and the heater control logic board has been successful.

LED	Description
	The communication between the heater control logic board and the Omnii main system has been established successfully.
	The communication between heater control logic board and the Omnii main system has failed.

Voltage (Heater System)

This indicates the voltage applied to the heater system.

Current

This option indicates the total average current used by the heating system.

Power

This value represents the total power used by the heating system.

Temperature

This indicates the temperature measured inside the unit.

Humidity

This indicates the humidity measured inside the unit.

Display and Scan Window Heaters





This section displays information on the individual heaters.



NOTE If the scanner/imager is not connected, the scan window heater will be disabled (greyed out).

Status

These LED status indicators report the heating mode for each individual heater.

LED	Description
	Blue indicates that the heating element is operating in full power mode.
	Green indicates that the heating element is operating in sustaining mode.
	Grey indicates that the heating element is off.
	Red indicates that there is a hardware failure with the heater.

Current

This indicates the average current drawn at the moment for the individual heater.

Power

This indicates the power used at the moment for each individual heater.

Temperature

This shows the temperature measured near the heating element. Note that the temperature units (C or F) can be selected at the top of the Heater Info tab. Once set, the selection is stored.

System Test

The system test feature allows the user to test the functionality of all available heaters (for approximately 20 seconds) to make sure that the heating system – heaters and control board – are working properly.

System Properties

The System Properties window displays the heater software and hardware components.

- Tap on **Start>Settings>System>System Properties** icon and scroll to **Heater Info**. The information also includes heater identification, version or part numbers, and indicates if they are installed.

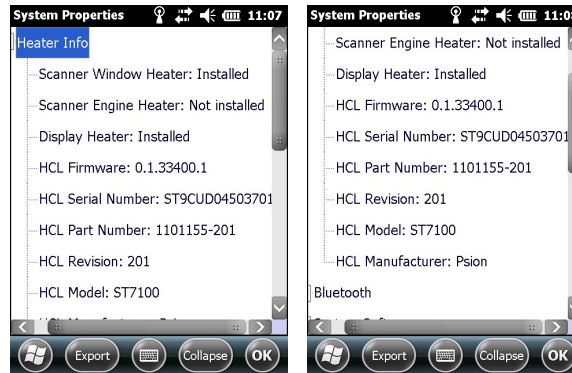

APPENDIX G WIRELESS WIDE AREA NETWORK (WWAN)

Wireless WAN	G-3
Navigation Bar Icons	G-3
Establishing a Packet Data Connection	G-3
Disconnecting from a Network	G-5
Advanced Packet Data Configuration	G-5
Manually Adding a New Modem Connection.	G-5
The Security Tab – Entering a PIN	G-7
Bands	G-7
Network Configuration	G-8

Wireless WAN

Zebra offers the Cinterion MC75i EDGE WWAN radio and a Cinterion PH8-P HSPA+ WWAN radio. An Omnii Hand-Held Computer equipped with a GSM/GPRS radio has wide area networking capabilities. With this radio and a SIM card, you can wirelessly transfer data, and you use the Omnii voice option to place phone calls.

Navigation Bar Icons

Wireless WAN icons are displayed in the navigation bar at the top of the screen that identify the packet data service and the signal strength.

When a modem detects that a packet data service is available, a letter is added to the signal strength icon indicating the type of service. Keep in mind that the signal strength icon is displayed without a letter if packet data service is not available, or if it is available but not yet initialized.

The symbols in the navigation bar identifying the modem connection are as follows:

- G - GSM/GPRS
- E - GSM/EDGE
- U - UMTS 3G
- H - UMTS/HSPA+

Establishing a Packet Data Connection

To display the Data tab through which you can configure a connection:

- Tap on the a **Navigation bar** at the top of the screen to display the hotkeys. Tap on the **Phone Settings** hotkey.

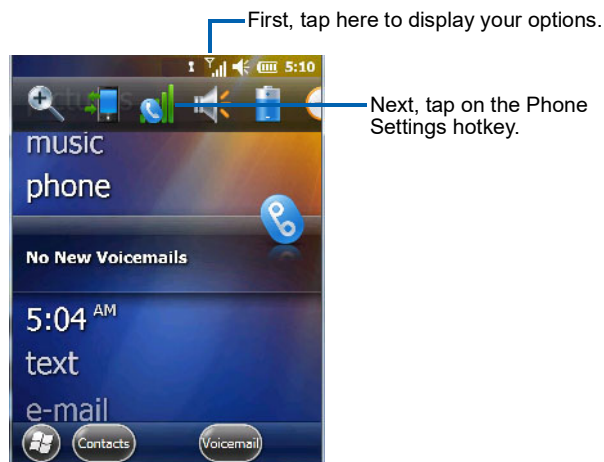

- In the Phone Settings bubble, tap on **Settings** to display the phone setting tabs.

Tap here to display the phone setting tabs.

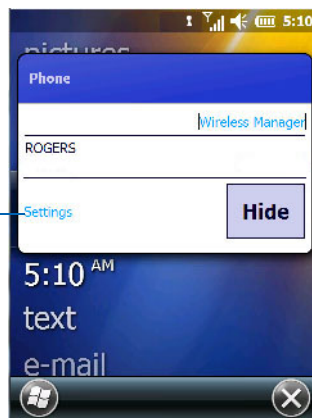

- Scroll to the **Data** tab.

Figure G-1 Data Tab

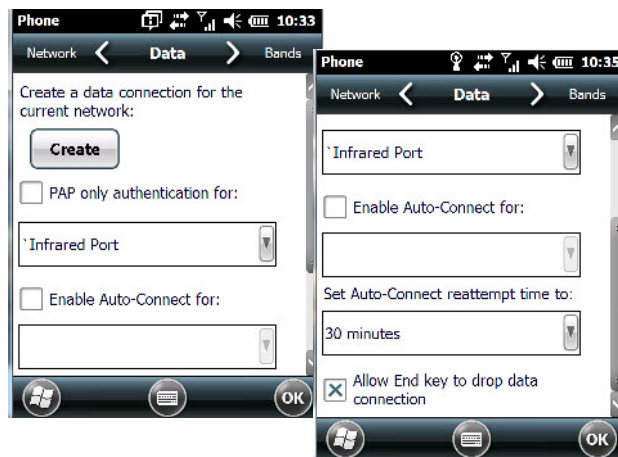

By default the connection uses CHAP (Challenge Handshake Authentication Protocol); however, if your ISP does not support CHAP, tapping in the box to the left of PAP only authentication for: directs the connection to use PAP (Password Authentication Protocol) instead.

- Tap on the **Create** button.

A home data connection is automatically set up.

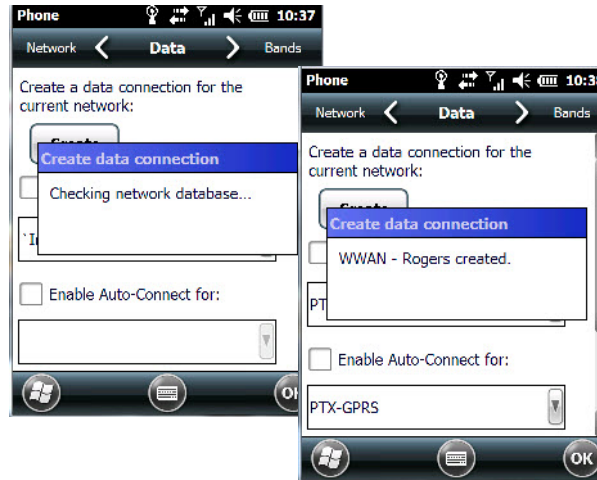

- To connect to the Internet, tap on the **Start>Internet Explorer** icon.



NOTE Any application that needs Internet access will establish a packet data connection – for example, e-mail.

Disconnecting from a Network

To disconnect from the network:

- Tap on the **navigation bar** at the top of the screen, and then tap on the **Phone Settings hotkey**. In the pop-up Phone bubble, tap on **Wireless Manager**.
- Tap on the **Menu** button in the softkey bar at the bottom of the Wireless Manager screen, and choose **Disconnect Cellular Data**.

Advanced Packet Data Configuration

In most cases, when a GSM/GPRS/EDGE radio and SIM are installed in your hand-held, setup is automatic. Follow the steps outlined under the heading “[Establishing a Packet Data Connection](#)” on page G-3 to make a connection. The information in this section is for advanced setup purposes.

Manual configuration should only be necessary if:

- One or more parameters in the database are incorrect or a new operator is not yet in the database. (The database should be corrected for subsequent software releases.)
- An operator has assigned individual GPRS user names and passwords.
- A very large site has its own Access Point Name (APN). Such connections must be configured manually.
- A customer has subscribed for a static IP address. By definition this must be configured manually.

Manually Adding a New Modem Connection

- Tap on **Start>Settings>Connections folder icon**. Tap on the **Connections** icon.

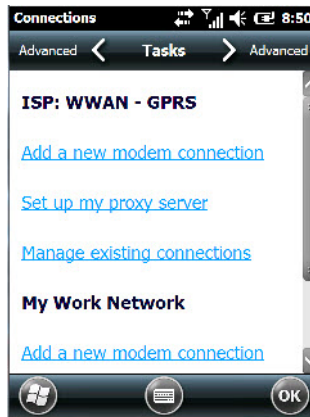

- Choose **Add a new modem connection**.

In most cases, you should choose Add a new modem connection from ISP: WWAN - GPRS. However, if you need to use a Proxy server, choose this option from My Work Network.

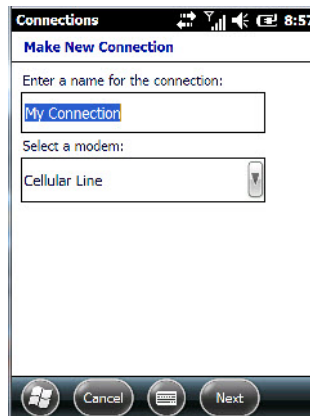

- Enter a **connection name** (optional).
- Choose **Cellular Line (GPRS)** from the Modem drop-down menu.
- Tap on **Next**.

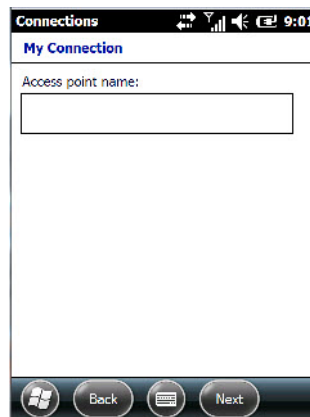

- Type the **Access Point Name**, and tap on **Next**.

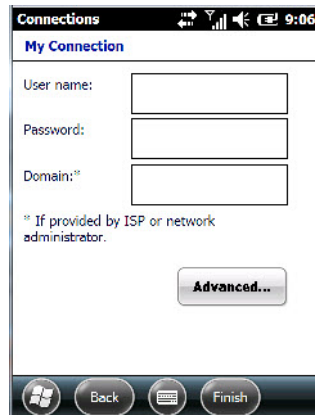

- If required, type a **User name** and **Password**.
- If you need to specify TCP/IP and Server information (i.e., you are using a static IP address) tap on the **Advanced...** button to complete the necessary details.
- Tap on **Finish** to create a new connection.

The Security Tab – Entering a PIN

This option allows you to assign a PIN (Personal Identification Number) so that your SIM card is protected from unauthorized use.



NOTE For details about assigning a PIN number, refer to [“Phone: Security Tab”](#) on page 4-53.

Bands

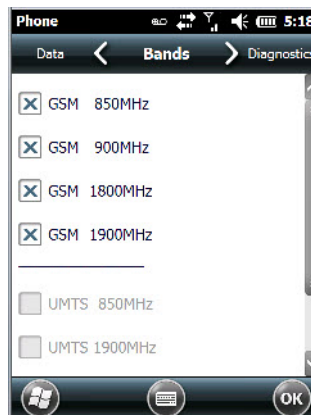

By default, all frequency bands are enabled. Bands should not be disabled without knowledge about which bands are used by your network; an incorrect setting will prevent the WWAN modem from finding the network.

Network Configuration

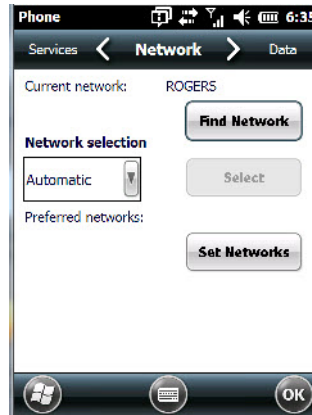

By default the radio modem automatically chooses from the available and allowed networks (allowed networks are the home network and all other networks with which the home network has a roaming agreement). You may find there are some situations in which you want to override this default behaviour. For example, you might want to disable roaming if you find yourself in a border area where the home network is not available but a foreign roaming partner is available. Abroad, you may find that an available network does not have GPRS roaming agreements. In this case, you'll need to manually select the network which you know supports GPRS roaming.

Automatic network selection is enabled by default. You can also choose a network manually from the drop-down menu.



NOTE Your home network operator will need to let you know which other networks have roaming agreements. Even when a network is listed with an 'Available' status, it does not necessarily follow that it can be used or that the roaming agreement covers GPRS.

Hearing Aid

This tab allows you to enable the hearing aid service.

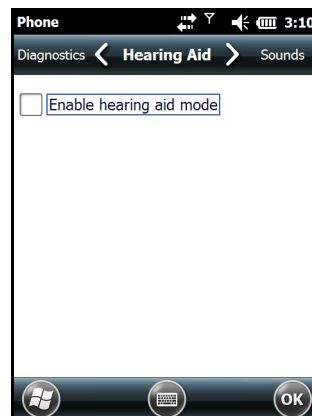

APPENDIX H OMNII XT15NI NON-INCENDIVE SAFETY GUIDELINES

Omnii XT15ni (non-incendive) Important Safety & Regulatory Information	H-3
Omnii XT15ni Battery Information	H-4

Omni XT15ni (non-incendive) Important Safety & Regulatory Information

The Omni XT15ni (non-incendive) Hand-Held Computer has been qualified by UL LLC to the requirements of the USA and Canada for use in Class I, Division 2-Groups A, B, C and D T6 environments.

The users of this product are cautioned to use accessories and peripherals approved by Zebra. The use of accessories other than those recommended, or changes to this product that are not approved by Zebra, may void the compliance of this product and may result in the loss of the user's authority to operate the equipment.



WARNING This mark indicates that the user should read all included documentation before use.



WARNING Ce marquage indique que l'utilisateur doit, avant l'utilisation, lire toute la documentation incluse.



WARNING Explosion Hazard-Substitution of components may impair suitability for Class I, Division 2 locations.



WARNING This unit has **NO OPERATOR REPLACEABLE PARTS** other than the battery pack. Disassembly/assembly of the Omni XT15ni must be performed by trained Zebra service personnel at a Zebra service depot. No unauthorized substitution of parts is allowed for the Omni XT15ni hand-held.



Use **ONLY** the Zebra Model ST3001-NI battery pack in the Omni XT15ni. No substitutions are permitted without authorization from Zebra/Zebra personnel.



DO NOT CHARGE OR CHANGE BATTERIES in an area that is known to be hazardous. Replace batteries in an area known to be non-hazardous.



EXPLOSION HAZARD. DO NOT REMOVE OR REPLACE LAMPS, FUSES OR PLUG-IN MODULES (AS APPLICABLE) UNLESS POWER HAS BEEN DISCONNECTED OR THE AREA IS KNOWN TO BE FREE OF IGNITIBLE CONCENTRATIONS OF FLAMMABLE GASES OR VAPORS.



EXPLOSION HAZARD. DO NOT DISCONNECT WHILE THE CIRCUIT IS LIVE UNLESS THE AREA IS KNOWN TO BE FREE OF IGNITIBLE CONCENTRATIONS.



WARNING Exposure to some chemicals may degrade the sealing properties of materials used in the following devices: battery packs, housings, LCDs, touchscreens, keypads.

Replacement of modules, housings, keypads, LCDs or touchscreens, end-caps, pods or external connectors must only be performed at an authorized Zebra service centre.



The battery pack used in this device may present a fire or chemical burn hazard if mistreated. Do not disassemble, heat above 100°C (+212°F) or incinerate. Dispose of used battery packs promptly. Keep away from children.



WARNING The following additional warnings and cautions must be observed for the safety of the operator and others in potentially hazardous locations:

The Omnii XT15ni must only be used when the ambient temperature is between -20°C and +50°C (-4°F and +122°F).

The Omnii XT15ni may NOT be connected to any of its available accessories while in potentially hazardous locations. This includes anything that uses the communications docking connector, headset, or microphone jacks. All allowed connections must be made while outside of the potentially hazardous location.

The use of Compact Flash, Secure Digital, and SIM Cards in the Omnii XT15ni while in potentially hazardous locations is permitted as long as these cards are not removed or changed while in the hazardous location.

Any connector cover removed while in ordinary locations must be reinstalled before entering a potentially hazardous location.

Omnii XT15ni Battery Information

The Omnii XT15ni hand-held operates with a specially adapted battery, model number ST3001-NI.



WARNING The battery pack used in this device may ignite, create a chemical burn hazard, explode, or release toxic materials if mistreated. Do not incinerate, disassemble, or heat above 100°C (212°F). Charge ONLY with Zebra Model ST3001-NI. Do not short circuit; may cause burns. Keep away from children.

Use ONLY Zebra battery pack Model ST3001-NI. Risk of fire or explosion if incorrect battery pack is used. Promptly dispose of used battery pack according to the instructions.



WARNING Le bloc-piles utilisé dans cet appareil peut prendre feu, constituer un risque de brûlure chimique, exploser ou dégager des substances toxiques s'il est manipulé de façon inappropriée. Ne pas jeter au feu, démonter ou chauffer à plus de 100°C (212°F). Ne charger qu'avec les dispositifs Zebra ST3001-NI. Ne pas court-circuiter; cela pourrait causer des brûlures. Garder hors de la portée des enfants.

N'utiliser que le modèle de bloc-piles Zebra ST3001-NI. L'utilisation d'un mauvais bloc-piles pourrait constituer un risque d'incendie ou d'explosion. Mettre rapidement au rebut tout bloc-piles usé, conformément aux instructions.

INDEX

Numerics

- 1D internal scanner 2-18, 2-19
- 2D imager 2-19
- 34-key freezer keyboard F-6
- 36-key keyboard
 - alpha keys, accessing 2-11
 - uppercase letters, creating 2-12
- 58-key freezer keyboard F-6

A

- A.R.C WiFiConnect (private network) 3-39
- About, Bluetooth 4-20
- About icon (software version) 4-58
- accessories
 - carrying case 5-5
 - desktop docking stations 5-10
 - Ethernet cable 5-17
 - hand strap 5-4, 5-5
 - holster, hard shell 5-5
 - pistol grip 5-3
 - quad docking station 5-15
 - vehicle cradle 5-18
- ActiveSync 3-27
 - setting up 3-27
- AC Wall adaptor 5-8
- AGPS (Assisted Global Positioning System) 4-69
- All
 - Predefined preset B-4
- ALT Key 2-8
- appending to bar codes
 - characters 4-90
- App Launch Keys 4-43
- approvals, Omnii freezer (including scanner) F-5
- arrow keys
 - moving the cursor 2-8

- audio indicators
 - adjusting volume 2-16
 - description of beep conditions 2-16
- AutoRestore 4-102

B

- backlight
 - Battery Power tab 4-60
 - intensity 2-12
- Backlight tab 4-58
- backlight timeout values 4-9
- Backspace (DEL Key) 2-8
- backup profile, creating (Total Recall) 4-99
- backup Profile (Total Recall)
 - AutoRestore 4-102
 - Clone to USB 4-102
 - Restore 4-102
 - restoring 4-101
 - Upload to A.R.C. 4-102
 - viewing 4-101
- backups, managing profiles 4-101
- Bad Scan Beep** 4-91
- Bar code
 - Decoding symbology predefined presets B-3
- bar code
 - appending to 4-90
 - displaying type of bar code 4-90
 - good and bad scan, vibrate settings 4-91
 - Options tab 4-89
 - Translation tab 4-92
- barcode
 - parameters C-3
- barcode reader
 - integrated scanner, operation of 2-17
- bar code symbologies
 - color camera B-20, B-21

- imager B-20
 - batteries
 - Advanced (backlight) tab 4-9
 - Battery (capacity) tab 4-9
 - Battery Details tab 4-10
 - Battery Health tab 4-11
 - Battery Power tab 4-60
 - Suspend Threshold tab 4-10
 - battery 2-5–2-6
 - charger safety instructions 5-9
 - charging 2-6, 5-9
 - charging with desktop docking station 5-13
 - installing 1-6
 - removing 1-6
 - replacing 1-6
 - specifications (ST3001) F-6
 - ST3006 6-slot battery charger 5-26–5-28
 - swap time 2-5
 - Battery Power settings 4-59
 - Baud, port replicator 4-93
 - beeper
 - adjusting volume 2-16
 - description of beep conditions 2-16
 - Bluetooth
 - microphone, adjusting volume 4-75
 - pairing 4-17
 - radio ISM band 4-14
 - Bluetooth setup 4-14
 - About Tab 4-20
 - GPRS setup 4-21
 - Mode tab 4-19
 - Paired tab 4-20
 - Servers tab 4-18
 - Boot to BooSt 1-8
 - built-in microphone, adjusting volume 4-75
- ## C
- calendar
 - attendees, assigning 2-29
 - categories, using 2-28
 - creating & editing entries 2-27
 - deleting appointments 2-29
 - reminders, creating 2-28
 - status, assigning 2-29
 - using 2-26
 - calibrating touchscreen 2-13
 - camera, using 3-17
 - case, carrying 5-5
 - Certificates 4-60
 - chargers 5-9
 - desktop docking station 5-10
 - indicators 5-13
 - installing at a site 5-10
 - operation 5-13
 - operator controls 5-10
 - safety instructions 5-9
 - Snap Modules 5-6
 - ST4004 operator controls 5-16
 - ST4004 quad docking station 5-15
 - troubleshooting 5-18
 - clean start 1-7
 - Click Data** (scanner double-click) 4-90
 - Click Time** (scanner double-click) 4-90
 - clone (Total Recall) 4-100
 - Clone to USB 4-102
 - Code Page**
 - Default Local ASCII** 4-91
 - ISO-8859-1 Latin 1)** 4-91
 - code page (Data Handling) 4-91
 - cold reset 1-7
 - communication
 - ActiveSync 3-27
 - Ethernet connection (quad docking station) 5-17
 - Compass 4-62
 - connecting to a server with 3-38
 - Connections
 - editing settings 4-30
 - Internet 4-23
 - managing 4-29, 4-30
 - modem setup 4-24
 - network, selecting 4-32
 - Network Cards 4-27
 - Proxy Server setup 4-31
 - VPN, setting up 4-29
 - Wi-Fi Configs 4-33
 - Wireless Manager 4-42
 - Connections (Internet) 4-23
 - Connections (settings) 4-13
 - Contacts (Start screen) 3-12
 - adding new 3-14
 - working with 3-13
 - Contrast adjustments 4-63
 - Control Panel
 - Predefined presets B-3
 - Copyright information, operating system 4-58
 - cradle *See also* vehicle cradle 5-18
 - CTRL Key 2-8
 - Custom preset B-3
- ## D
- Data Bits, port replicator 4-94
 - data entry modes
 - handwriting 3-36
 - typing 3-36
 - Data Handling (code page) 4-91
 - Data tab, setting up 4-56

- debug (error handling) 4-63
 - Decoding symbology
 - Predefined symbology B-3
 - Default
 - Predefined preset B-4, B-5
 - Default identifier
 - Preset group B-3
 - Default Local ASCII (Code Page)** 4-91
 - Defrost applet (freezer variant) F-8
 - DEL (Backspace) Key 2-8
 - Demo Scanner 3-31
 - desktop docking station *See* docking station, desktop . . . 5-10
 - desktop screen (Home Screen) 2-21
 - Device ID tab 4-58
 - display
 - backlight, adjusting 2-12
 - docking station 5-9–5-10
 - desktop 5-10–5-14
 - cleaning 5-13
 - indicators 5-13
 - operation 5-13
 - operator controls 5-10
 - troubleshooting 5-14
 - installation at site 5-10
 - ST4004, quad
 - operator controls 5-15, 5-16
 - uploading data using 2-36
 - docking stations
 - quad docking station (ST4004) 5-15
 - double-click
 - appending characters to a decoded
 - bar code 4-90
 - scanner trigger 4-90
 - Double-Click, Manage Triggers menu** 4-72
 - Dr. Debug 4-63, 4-64, 4-65
- ## E
- E-mail 3-9
 - folders 3-9
 - Outlook e-mail, synchronizing (Windows Vista and 7)
 - 3-11
 - Outlook e-mail, synchronizing (Windows XP) 3-9
 - e-mail notification 2-26
 - Encryption (storage card) 4-65
 - Error Reporting 4-66
 - ESC Key 2-8
 - Ethernet, connecting with docking station 5-17
 - Excel Mobile 3-32
 - External Power settings 4-59
- ## F
- Favorites 2-29
 - Add Remove 2-29
 - file, renaming 2-32
 - File Explorer 2-31, 3-26
 - copy 2-32
 - copying a file 2-32
 - deleting file 2-33
 - folders, creating 2-32
 - renaming file 2-32
 - files & folders, managing 2-31
 - folder, copying 2-32
 - folder, creating 2-32
 - folder, deleting 2-33
 - folder, renaming 2-32
 - freezer keyboards F-6
 - Freezer variant (XT15f) F-3
 - Function Keys
 - 36-key keyboard 2-10
 - 59-key keyboard 2-10
- ## G
- gang charger 5-26–5-28
 - Glossy surface
 - Predefined preset B-5
 - Good and Bad Scan Vibrates** 4-91
 - Good Scan Beep** 4-91
 - GPRS (bluetooth) 4-21
 - GPS (external) 4-66
 - GPS Settings (built-in profiles) 4-68
 - Group, preset B-3
 - GSM UMTS radio modem connection G-3
- ## H
- hand strap 5-4
 - hand strap, installing 5-5
 - Hard Reset 1-8
 - headset, adjusting volume 4-75
 - headsets, pairing (Bluetooth) 4-17
 - Heater Info (Heater Settings) F-9
 - Heater Settings
 - Heater Info F-9
 - heater settings (freezer variant) F-9
 - holster, hard shell 5-5
 - Home
 - appearance, changing 4-7
 - Home icon (Start screen) 3-3
 - Home Screen (desktop screen) 2-21
 - customizing 2-22
 - hotkeys (navigation bar) 2-29
 - HSP HFP (Headset Profile Hands-Free Profile) Service
 - Commands (Bluetooth pairing) 4-21

I

Identifier	
Default preset group	B-3
imager	
two dimensional (2D) imager	2-19
Imager Settings	4-71
indicators	
LED functions	2-14
scanner message	2-18, 2-19, 2-20
softkey bar	2-31
input modes	
handwriting	3-36
typing	3-36
installation	
hand strap	5-5
pistol grip	5-3
Snap Modules	5-6
vehicle cradle	5-18
integrated scanner option	2-17
Internet connection	4-23
Internet Explorer	3-15
browsing web sites	3-15
Internet Sharing	3-27
ISM band, Bluetooth radio	4-14
ISO-8859-1 Latin 1 (code page)	4-91

K

keyboard	
36-key keyboard	2-11
alpha keys, 36-key keyboard	2-11
one shot mode	4-46
Scancode remapping	4-49
Unicode Mapping	4-48
keyboard keys	2-6
ALT	2-8
arrow keys	2-8
Backspace	2-8
CTRL	2-8
DEL	2-8
ESC	2-8
function keys, accessing	2-10
Macro keys	4-47
macro keys	2-11
modifiers	2-8
navigating using the keyboard	2-20
one shot mode	4-46
SCAN	2-8
Scancode Remapping	4-49
SHIFT	2-7
shift-state indicator icon	2-30
SPACE	2-8
Tab	2-8

Unicode Mapping	4-48
keyboard keys, freezer	F-6
keypad, adjusting	4-53
keypad (phone)	3-4
Kiosk	
Shell Settings	4-78
Advanced tab	4-80
Application tab	4-78
Phone tab	4-83
Kiosk application	4-76

L

landscape orientation	2-13
LED	
charge	2-15
functions	2-14
scan	2-15
troubleshooting quad dock ST4004	5-18
Linear	
Predefined preset	B-4
Linear and PDF	
Predefined preset	B-4
Lithium-ion batteries	
installing	1-6
removing	1-6
replacing	1-6
Lock Sequence	4-51
Low light	
Predefined preset	B-4
Low light near	
Predefined preset	B-5
Low power	
Predefined preset	B-5

M

Macro keys	
36-key keyboard	2-11
59-key keyboard	2-11
accessing	2-11
deleting a macro	4-48
executing a macro	4-48
Macros menu, accessing	4-47
recording and saving	4-47
maintenance	2-37
Managed Programs	4-74
mapping	
Scancode	4-49
Unicode	4-48
Matrix	
Predefined preset	B-4
Memory	4-74
Storage Card tab	4-75

- menus
 - pop-up 2-33
 - using 2-33
 - messages
 - Scan Indicator** 4-90
 - scanner warning message 4-90
 - Scan Result** 4-90
 - Messaging
 - Outlook e-mail, synchronizing 3-9, 3-11
 - Microphone, adjusting volume (Built-in, Headset and Bluetooth) 4-75
 - microSD Card, inserting 2-16
 - Microsoft® ActiveSync® 2-36
 - Mobile Device Center (Windows), setting up 2-37
 - Mode, Bluetooth 4-19
 - modem setup 4-24
 - Server Settings 4-26
 - TCP_IP Settings 4-25
 - modifier keys 2-8
 - locking 2-9
 - OneShot Mode 4-46
 - shift-state indicator icon 2-30
 - unlocking 2-9
 - Motion Meter 4-65
- ## N
- name, assigning to WORKABOUT PRO3 4-58
 - navigation bar
 - hotkeys 2-29
 - shift-state indicator 2-30
 - network, selecting 4-32
 - network (phone), setting up 4-55
 - non-incendive Omnii XT15ni H-3
 - Note
 - recording a message (audio) 3-23
 - renaming 3-23
 - soft keyboard 3-21
 - text, converting handwriting into 3-22
 - transcriber 3-22
 - Notes 3-21
 - Notification, setting 4-12
 - Notifications and Sound, defining 4-12
- ## O
- OBEX OPP (Object Exchange-Object Push Profile) 4-19, 4-21
 - Omnii
 - approvals F-5
 - model numbers xx
 - model numbers (freezer variants) F-3
 - XT15f Freezer specifications F-3
 - Omnii XT15ni (non-incendive) hand-held H-3
 - On & Off button 1-6
 - one dimensional internal scanner 2-18, 2-19
 - OneShot Mode 4-46
 - OneShot tab (modifier keys) 4-46
 - Options tab (bar codes) 4-89
 - orientation, screen 2-13
 - Outlook e-mail, synchronizing (Windows Vista and 7) 3-11
 - Outlook e-mail, synchronizing (Windows XP) 3-9
- ## P
- Paired tab (Bluetooth) 4-20
 - pairing Bluetooth devices 4-17
 - Parity, port replicator 4-94
 - Password (admin), changing (Kiosk) 4-78
 - PDF and linear
 - Predefined preset B-4
 - Personal apps 4-43
 - App Launch Keys 4-43
 - phone
 - Data tab 4-56
 - keypad 3-4
 - keypad tab 4-53
 - Network (phone), setting up 4-55
 - phone keys (on the EP10 keyboard) 3-5
 - PIN, changing 4-53
 - ring tone adjustments 4-53
 - security tab 4-53
 - Services, setting up 4-55
 - settings, managing 3-8, 4-51
 - sound tab 4-53
 - using (Windows Mobile 6.5 Professional) 3-4, 4-51
 - Voice Mail, setting up 4-55
 - Phone communication 1-9
 - phone network, setting up 4-55
 - picker cradle, installing cable 5-23
 - Pictures
 - deleting 3-18
 - editing 3-18
 - opening 3-18
 - slide show, creating 3-19
 - Pictures and Videos 3-17
 - pinouts B-1
 - pistol grip, installing 5-3
 - Pocket Word 3-36
 - port pinouts B-1
 - portrait orientation 2-13
 - Port Replicator settings (COM5 and COM6)
 - Baud 4-93
 - Data Bits 4-94
 - Parity 4-94
 - Port B (COM6), Power 4-93
 - Stop Bits 4-94
 - Trigger On Sequence 4-94

Postal	
Predefined preset	B-4
Power	
Advanced tab (backlight timeout)	4-9
Battery (capacity) tab	4-9
Battery Details tab	4-10
Battery Health tab	4-11
Suspend Threshold tab	4-10
to Port B (COM6)	4-93
Power button	1-6
Predefined preset	B-3
All	B-4
Default	B-4, B-5
Glossy surface	B-5
Linear	B-4
Linear and PDF	B-4
Low light	B-4
Low light near	B-5
Low power	B-5
Matrix	B-4
Postal	B-4
Preset	
Custom	B-3
Group	B-3
Group default identifier	B-3
Predefined	B-3
Preset group	
Default identifier	B-3
private network (WiFiConnect A.R.C.)	3-39
Profile	
restoring backup	4-101
viewing backup	4-101
profile, creating backup	4-99
Programs	2-34, 3-3
minimizing	2-34
opening	2-34
protective case	5-5
proxy server, setting up	4-31
punctuation marks, accessing (SHIFT Key)	2-7

Q

Query Services (Bluetooth pairing)	4-21
Quick Defrost (heater settings)	F-9
Quick Defrost applet	F-8
Quick Defrost Settings	
Quick Defrost	F-9

R

recalibrating touchscreen	2-13
Regional Settings	4-87
remapping	
Scancode	4-49

Unicode	4-48
Remote Desktop Mobile	3-38
Remove Programs	4-88
resetting Omnii	
Boot to BooSt	1-8
clean start	1-7
cold reset	1-7
Hard Reset	1-8
warm reset	1-7
Restore Now	4-102
ring tone adjustments (phone)	4-53

S

safety instructions	
battery charger	5-9
scanner	2-17
safety warning, scanner	2-17
Scancode remapping	4-49
Scan Indicator	4-90
SCAN Key	2-8
Scan Log File	4-91
scanner	
one dimensional (1D) internal scanner	2-18, 2-19
safety warnings	2-17
techniques (scanning)	2-18
troubleshooting tips	2-19
scanning	
1D internal	2-18, 2-19
appending characters	4-90
Bad Scan Beep	4-91
bar code settings	4-89
Click Time	4-90
Data Handling (code page)	4-91
double-click	4-90
Good and Bad Scan Vibrates	4-91
Good Scan Beep	4-91
Options tab	4-89
safety instructions	2-17
Scan Indicator	4-90
Scan Log File	4-91
Scan Result	4-90
Scan Result Time	4-90
symbolologies	C-3
Translations tab	4-92
Scan Result	4-90
Scan Result Time	4-90
screen	
stylus, using to navigate	2-20
touch pen, using	2-20
Windows Embedded CE, navigating	2-20
scrolling, adjusting speed (Up_Down tab)	4-46
security, setting up phone	4-53
Server Settings (modem setup)	4-26

- Server tab (Bluetooth) 4-18
 - OBEX OPP (Object Exchange-Object Push Profile)4-18, 4-19, 4-21
 - Scanner 4-18
 - Serial 4-18
 - Set for AutoRestore 4-102
 - Settings 2-35
 - Personal Tab
 - OneShot tab 4-46
 - Up_Down tab 4-46
 - Task Manager, working with 2-34
 - Settings tab (error level & log folder) 4-65
 - Shell Settings (Kiosk) 4-78
 - Advanced tab 4-80
 - Application tab 4-78
 - Phone tab 4-83
 - SHIFT Key 2-7
 - shift-state indicator, accessing 2-30
 - shift-state indicator (navigation bar) 2-30
 - SIM card, inserting 2-16
 - SM Toolkit UI 3-39
 - Snap Modules
 - ST4000 (power only) 5-6
 - ST4001 (USB Host/Client) 5-6, A-4
 - ST4005 (USB DE9M) 5-7, A-4
 - softkey (softkey bar) 2-31
 - softkey bar
 - softkey 2-31
 - soft keyboard icon 2-31
 - softkeys 2-31
 - soft keyboard, using 3-21
 - soft keyboard icon (softkey bar) 2-31
 - softkeys (softkey bar) 2-31
 - Soft Scan Timeout** 4-91
 - sound, adjusting 4-53
 - Sound, setting events 4-12
 - Sound and Notifications, defining 4-12
 - Sound settings 4-12
 - SPACE Key 2-8
 - specifications
 - Omnii XT15f Freezer Hand-Held Computer F-3
 - Symbol SE4600 imager D-16
 - ST4000 Snap Module 5-6
 - ST4001 Snap Module 5-6, A-4
 - ST4004 quad docking station 5-15
 - cleaning 5-17
 - Ethernet 5-17
 - troubleshooting 5-18
 - ST4005 Snap Module 5-7, A-4
 - Start Menu 2-31
 - Start screen
 - Contacts icon 3-12
 - Home icon 3-3
 - Status tab, browsing error logs 4-64
 - Stop Bits, port replicator 4-94
 - Storage Card tab 4-75
 - stylus (touch pen), using 2-20
 - Surface
 - Glossy B-5
 - suspend (turn off screen) 4-10
 - swap time (for battery) 2-5
 - symbologies, barcode C-3
 - Symbol SE4600 imager specifications D-16
 - Symbol Soft Input Panel (figure) 2-9
 - synchronizing e-mail (Windows Vista and 7) 3-11
 - synchronizing e-mail (Windows XP) 3-9
 - System apps
 - About 4-58
 - Admin Password, changing (Kiosk) 4-78
 - AGPS (Assisted Global Positioning System) 4-69
 - Backlight 4-58
 - Battery Power settings 4-59
 - Certificates 4-60
 - Contrast 4-63
 - Encryption 4-65
 - Error Reporting 4-66
 - External Power settings 4-59
 - GPS (external) 4-66
 - GPS Settings (built-in profiles) 4-68
 - Imagers Settings 4-71
 - Kiosk 4-76
 - Managed Programs 4-74
 - Memory 4-74
 - trigger mappings 4-72
- ## T
- Tab Key 2-8
 - task
 - completed (marking as) 3-26
 - creating 3-24, 3-25
 - deleting 3-26
 - editing 3-25
 - notification 3-24
 - sorting 3-26
 - Task Manager 2-34, 4-97
 - TCP_IP Settings (modem setup) 4-25
 - Terminal Services Client 3-38
 - session, disconnecting (without ending) 3-39
 - session, ending 3-39
 - Total Recall 4-98
 - AutoRestore Profile 4-102
 - backup profile, creating 4-99
 - backup Profile, restoring 4-101
 - clone, creating 4-100
 - Clone to USB 4-102
 - managing profiles 4-101

Restore Profile	4-102
Upload to A.R.C.	4-102
view Profile	4-101
touch pen, using	2-20
touchscreen	
locking	2-13
orientation	2-13
recalibration	2-13
stylus, using	2-20
touch pen, using	2-20
transcriber (handwritten note)	3-22
Translations parameters (bar codes)	4-92
trigger mappings	4-72
Trigger On Sequence, port replicator	4-94
Trigger Press Type , Manage Triggers menu	4-74
troubleshooting	
ST40004	5-18
troubleshooting tips (scanning)	2-19
TweakIT	4-103

U

Unicode Mapping	4-48
Up_Down tab (scrolling adjustments)	4-46
Upload to A.R.C.	4-102
Utilities tab	4-64

V

vehicle cradle	5-18
Version tab	4-58
vibrate, setting up for incoming calls	4-13
Vibrates, Good and Bad Scan	4-91
video recorder, using	3-19
Videos and Pictures	3-17
Voice	
phone communication	1-9
voice mail, setting up	4-55
VPN connection, setting up	4-29

W

warm reset	1-7
warnings	4-90
WiFiConnect A.R.C.	3-39
Windows 7	2-36
Windows Embedded CE, navigating in	2-20
Windows Mobile Device Center, setting up	2-37
Windows Vista®	2-36
Wireless Wide Area Network (WWAN)	G-3
Wireless Zero Config	4-41
Word Mobile	
data entry modes	3-36
Word <i>See</i> Pocket Word	3-36

WWAN (Wireless Wide Area Network)	G-3
GSM UMTS radio modem connection	G-3

X

XT15f Freezer variant	F-3
XT15ni (non-incendive) hand-held	H-3



ZEBRA and the stylized Zebra head are trademarks of Zebra Technologies Corporation, registered in many jurisdictions worldwide. All other trademarks are the property of their respective owners. ©2020 Zebra Technologies Corporation and/or its affiliates. All rights reserved.

